

## DUPAGE RIVER SALT CREEK WORKGROUP

# STREAM DISSOLVED OXYGEN IMPROVEMENT FEASIBILITY STUDY FOR SALT CREEK

---



## FINAL REPORT

SEPTMEBER 2009

Prepared by:



HDR Engineering, Inc.  
8550 W. Bryn Mawr Ave., Suite 900  
Chicago, IL 60603  
Job No. 31566

In Association with:



## Executive Summary

In October 2004, the Illinois Environmental Protection Agency (Illinois EPA) issued a completed Total Maximum Daily Load (TMDL) Study for Salt Creek. From this study, the Illinois EPA developed TMDL allocations for various pollutants. The report concluded that significant reductions in biochemical oxygen demand (BOD) and ammonia would be necessary in order for the Illinois Dissolved Oxygen (DO) standards to be achieved in Salt Creek during low-flow, warm conditions, and that the potential removal of one or more existing dams along lower Salt Creek could offer significant water quality improvements.

Since the publication of the TMDL report, affected communities, municipal wastewater treatment plant operators, and interested environmental organizations have joined together to form the DuPage River Salt Creek Workgroup (DRSCW). The mission of the DRSCW is to study the East and West Branches DuPage River and Salt Creek watersheds in order to gain a better understanding of environmental impairments that are leading to poor water quality and impacting aquatic life. The initial focus of the DRSCW, for this project, was to develop a computer model that would accurately reflect low-flow, warm stream conditions, particularly DO, along Salt Creek, from which alternatives for improving DO concentrations could be developed. While working on this task it became apparent that better environmental monitoring data were needed. At this point the focus of the Workgroup expanded to include design and implementation of water quality monitoring studies that would generate sound scientific data.

Salt Creek is a highly disturbed urban stream with low channel gradients and extensive channelization. The portion of lower Salt Creek assessed for this report spans approximately 12 stream miles (19 km), from above the Addison North Wastewater Treatment Plant which is located at River Mile 22.6 (36.2 km), to the Graue Mill Dam located at River Mile 10.7 (17.1 km). Along this stretch of lower Salt Creek there are three principle existing dams:

Name of Dam	River Mile (km)	Bounding Bridges		Nearest Town
		Upstream	Downstream	
Oak Meadows Golf Course	22.9 (36.8)	Elizabeth Dr	I-290	Wood Dale
Old Oakbrook	12.5 (20.1)	Oak Brook Rd / 31 <sup>st</sup> St	Fullersburg Woods Foot Bridge	Oak Brook
Graue Mill	10.7 (17.2)	Fullersburg Woods Foot Bridge	York Road	Hinsdale

Located along and upstream of the study area are seven municipal wastewater treatment plants, starting at the MWRDGC John Egan Plant at River Mile 29.6 (47.6 km) and extending downstream to the Elmhurst WWTP at River Mile 17.8 (28.6 km).

Based on two years of continuous DO monitoring, the DO above the Graue Mill Dam (within the Fullersburg Woods Impoundment) is the lowest on Salt Creek during low flow steady state conditions. Sediment Oxygen Demand (SOD) results within the Fullersburg Woods Impoundment are elevated from the quantities of sediment that have accumulated behind the dam and by the increase in the channel's wetted perimeter caused by the widening of the channel in the impoundment. Concurrent with these DO studies, the Workgroup also completed biological studies on Salt Creek which found that the Graue Mill Dam is acting as a physical barrier to fish migration, and that habitat quality on in the upstream impoundment was some of the poorest on the main stem of the river. Related parameters of fish and macro-invertebrate quality were also significantly degraded above the dam and the stream never fully recovers upstream.

Since 2005, the DRSCW has conducted extensive monitoring of Salt Creek in order to develop additional data to support a water quality model on Salt Creek. The model utilized, the QUAL2K model, includes the capability of diurnally varying headwater / meteorological input data and a full sediment diagenesis model to compute SOD and nutrient fluxes from the bottom sediment to the water column. In addition, the QUAL2K model offers options for decay functions of water quality constituents, re-aeration rate equations, heat exchange, and photo-synthetically available solar-radiation calculations.

Enhanced model input data were obtained for factors such as headwaters and tributaries, river distances, model geometry, meteorological data, decay rates, background light extinction, point sources, temperature, and stream flow. Also, recent DO measurement data were utilized from the continuous DO monitoring as well as several days of monitoring in 2005. SOD measurements were conducted on Salt Creek in 2006 and 2007 to provide input data by reach into the QUAL2K model.

Under low stream flow conditions, the contribution from the point source discharges to Salt Creek collectively account for 46% of the total flow at the model's downstream boundary. To calibrate the model August 2, 2007 data were utilized. Temperatures ranged from 23 to 31°C on this date, and the stream flow was essentially at low flow conditions. Overall, the model reasonably predicts the diurnal change in DO.

To verify the model will accurately predict DO changes under varying conditions, the model was tested for the conditions that existed on June 20, 2006. Overall, the measured minimum DO levels were lower than the model predicted; however, the results were within acceptable ranges. Sensitivity runs were completed for changes in SOD and changes in the re-aeration constants. Both of these variables have a significant impact on the predicted DO values; however, such changes did not improve the overall model.

Under the Illinois Pollution Control Board's regulations, DO water quality standards are to be achieved at all times. Therefore, alternatives need to be evaluated under the most severe conditions. For a variety of reasons, minimum DO levels occur during the high temperature extremes. As water temperature increases the amount of dissolved oxygen that the water can hold decreases resulting in losing oxygen to the atmosphere during periods of photosynthesis when supersaturation conditions occur. In addition, respiration increases (both in the water

column and in the sediment) with warmer temperatures. From a review of historical temperature data, Salt Creek can reach temperatures approximately 3°C above the levels recorded in July and August 2005. This higher stream temperature and low flow along with the average summer CBOD<sub>5</sub> and ammonia discharged from the seven wastewater treatment plants during the summer of 2005 were used as the baseline *worst case* scenario. Consistent with the monitoring results, under the baseline conditions the model predicts that the pool areas created by the dams are the areas where DO concentrations will be the lowest. In order of priority the lowest DO is predicted occurs above the Graue Mill Dam, then the Oak Meadows Dam, followed by the pool at Butterfield Road. Above the Old Oak Brook Dam, the minimum DO predicted was not as severe.

Significant enhancement of the DO and overall water quality of lower Salt Creek can be accomplished via the removal/bridging of the low-head dams in the study area. These dams inhibit the natural linear flow of energy and impede sediment transport, fish migration, feeding and breeding, macro-invertebrate drift, and downstream nutrient spiraling. With respect to DO, these low-head dams create impoundments that concentrate sediment and organic material upstream which actively respire, removing dissolved oxygen from the water. In addition, they slow the velocity of the water, allowing additional time for the creek water to absorb solar energy and increase in temperature. This effect is further exacerbated by the increased stream width created by the impoundment, thereby limiting the extent of riparian shade that can counter the effect of solar heating.

With respect to the dams along Salt Creek, two options were investigated for this study; complete removal and partial breaching/bridging. These options are being driven by the primary design objective of improving the DO content of the stream and a secondary objective to re-establish biological connectivity, mainly in the form of faunal passage. The social-cultural characteristics of a dam must be weighed against any modifications to the structure or impoundment.

Partial breaching involves removing just enough of the structure to allow unimpeded flow except for during the larger storm events. Under this scenario the impoundment is drained and a free flowing river restored. The basic concept of bridging is to build a ramp of large rock leading up to the downstream face of the dam, effectively “bridging” the dam and restoring upstream-downstream fish passage and possibly canoe passage as well. Common variations of this include lowering the dam crest in order to decrease the vertical elevation that must be made up downstream and to reduce the impoundment on the upstream side of the dam. In addition, notching the dam crest to concentrate flow in the center of the channel is also common. Bridging also provides interstitial habitat for macro-invertebrates and can also preserve a degree of elevated water surface upstream.

The characterization and understanding of reservoir sediments is a significant factor (cost) governing dam removal. In the early 1990s, the sediment above the Graue Mill Dam was removed and was not deemed contaminated, so it is reasonable to assume that would still be the case today.

Quantifying the flood impact of any project on the dams being studied is also necessary. As the dams on Salt Creek are low head dams, that are operated full, there will be little impact on the floodplain, either upstream or downstream.

Mechanical stream aeration is another option for improving DO levels in critical reaches of a stream. Available technologies can be divided into three categories: Air-Based Alternatives, High-Purity Oxygen Alternatives, and Side-Stream Alternatives, each of which can be further broken down by options. The lowest DO levels on Salt Creek occur within the impoundment above the Graue Mill Dam. Low DO values have also been noted near Butterfield Road; however, at this location the stream channel has been excessively widened and low DO periods could be corrected by restoring the natural channel through this area. In addition, limited DO data immediately above the Oak Meadows dam indicates that lower DO levels also occur in this stretch, and the modeling results are consistent with these observations. From a priority perspective, the lowest DO reach should be addressed first, which is the Fullersburg Impoundment above the Graue Mill Dam.

The quiescent conditions within the Fullersburg Impoundment are ideal for operating oxygen systems, as supersaturated DO levels can be readily achieved with minimal loss to the atmosphere within the impoundment. Side-stream air systems are also possible, but will require pumping rates that will approach the daily flow in Salt Creek, and elevated SOD within the impoundment will necessitate more than one side-stream to maintain the desired DO level above 5.0 mg/L. Bubble diffusers laid parallel to the flow within the impoundment would also be a viable option; however, increased maintenance to maintain the diffuser hoses above the silt after high-flow periods will be necessary. Surface aerators are not recommended, from an aesthetic perspective as well as from a maintenance perspective. In all cases, the operation of aeration devices is needed during the evening hours because when photosynthesis begins in the morning, DO levels rise above 5.0 mg/L until the early evening hours, when the supplemental aeration would be restarted. Unlike a dam removal/bridging project, which is basically a one-time cost for removal/modification, in-stream aeration will require funding in perpetuity. Such an operation would not improve the existing impediment to fish passage or remove the severe impairment to aquatic habitat identified at the site.

Using the *Baseline Conditions* model, various scenarios were evaluated to see what benefits would occur from various alternatives. Alternative 1 removed all of the pollutant loading from the seven wastewater treatment plants along Salt Creek. Even with the removal of all of the pollutants originating from the point source (BOD and ammonia), Salt Creek was unable to achieve the DO water quality standards of 5.0 mg/L upstream of any of the three dams. Once again no habitat improvement would accompany such a program.

Alternative 2 modeled removal of the Oak Meadows Dam and partial breaching of the Graue Mill Dam by 1 foot, 2 feet and 3 feet. Breaching (lowering) the Graue Mill Dam height by 2 feet is predicted to result in achieving DO water quality standards under the *Baseline Conditions*, and lowering the water elevation 3 ft would provide an additional margin of error in the predicted minimum DO levels. Above the Oak Meadows Dam, the DO improvement was only predicted to extend less than 1 mile (1.6 km). However, the confidence in the model inputs for the area above the Oak Meadows Dam are lower than elsewhere on Salt Creek, and additional DO

monitoring and recent improvements in the upstream wastewater treatment plant (Itasca) are expected to result in further DO improvements above the Oak Meadows Dam.

Alternative 3 evaluated in-stream aeration using air-based technology at discreet locations just upstream of the Oak Meadows and Graue Mill Dams. The model predicts that at each location two aeration stations will be required to achieve the minimum DO standards above each dam. Again, at Oak Meadows, there is some uncertainty that with the recent upgrade at the nearest upstream wastewater treatment plant and the current DO monitoring data, whether one in-stream aeration station would be sufficient.

Alternative 4 evaluated the use of high-purity oxygen aeration involving the injection of oxygen above the same two dams. A system of this type can readily supersaturate creek DO levels to 150%. The model predicts that this effort can maintain DO levels above the state water quality standards for reaches of up to 2.5 miles (4 km) above the Oak Meadows Dam and 1.25 miles (2 km) above the Graue Mill Dam. This achievement would result in the need for only one station at each location.

Factoring in the capital and operating costs, the net present value for each of the four alternatives was computed and is presented below for each location (OM-Oak Meadows Dam and GM-Graue Mill Dam):

	<b>Option</b>	<b>Net Present Value</b>	<b>Comment</b>	<b>Fish Passage/Habitat Improvement</b>
1	Eliminate Point Source Pollutants	> \$388,000,000	DO above Graue Mill Dam continues to drop to 3.8 mg/L	No
2	Oak Meadows Dam Removal and Bridging/Partial breach at Graue Mill	OM-\$250,000 GM-\$800,000 to \$1,100,000	Need to verify above Oak Meadows DO will not drop below 5.0 mg/L	Yes
3	Air based In-stream Aeration	OM-\$1,190,000 GM-\$2,050,000	Need to verify above Oak Meadows DO will remain above 5.0 mg/L with one aeration system	No
4	High purity Oxygen Addition	OM-\$1,410,000 GM-\$1,710,000	Need to verify above Oak Meadows will remain above 5.0 mg/L with one oxygen system	No

Dam removal at Oak Meadows is the low cost option, and has the added benefit of improvements in the biological community above the dam. However, additional verification is

necessary to demonstrate that the DO above this dam will achieve the water quality standard given the recent upgrade in the closest wastewater treatment plant.

Bridging or partial breach at Graue Mill is part of the low cost option at this location. However, the historical value of the Graue Mill Dam must also be factored into the ultimate selected remedy. The net present value (cost) estimate for the bridging/partial breach includes consideration of maintaining historical aspects of the dam.

# TABLE OF CONTENTS

EXECUTIVE SUMMARY .....	i
1. PROJECT BACKGROUND AND GOALS .....	1-1
1.1 Project Goal .....	1-1
1.2 Water Quality Standards .....	1-3
2. EXISTING CONDITIONS.....	2-1
2.1 Geomorphic Assessments .....	2-1
2.1.1 Channel Evolution .....	2-2
2.1.2 Bank Erosion.....	2-3
2.1.3 Sediment Transport.....	2-4
2.2 Stream Characterization.....	2-5
2.3 Flow Data.....	2-7
2.4 Reach Descriptions .....	2-8
2.5 Habitat Summary .....	2-12
2.6 Dam Site Investigations .....	2-13
2.6.1 Oak Meadows Golf Course Dam.....	2-14
2.6.2 Old Oak Brook Dam .....	2-17
2.6.3 Graue Mill Dam .....	2-19
2.7 Flood Control Reservoirs.....	2-21
2.8 Sediment Oxygen Demand (SOD) Field Measurements .....	2-22
2.9 Continuous Dissolved Oxygen Monitoring .....	2-23
2.10 Biological and Phosphorus Quality .....	2-26
2.11 Summary.....	2-28
3. WATER QUALITY MODELING .....	3-1
3.1 Conversion of QUAL2E to QUAL2K Model.....	3-1
3.2 Validation of QUAL2K Model.....	3-1
3.2.1 Model Inputs .....	3-2
3.2.2 Calibration and Verification of the Model.....	3-9
3.2.3 Sensitivity Analysis .....	3-11
3.2.4 Baseline Model .....	3-11
4. SCREENING FOR DAMS.....	4-1
4.1 Complete Removal.....	4-1
4.2 Partial Breach or Notching.....	4-2
4.3 Bridging .....	4-2
4.4 Issues Common to All Dams .....	4-3
4.4.1 Permitting.....	4-3
4.4.2 Reservoir Sediment.....	4-4
4.4.3 Flood Impact .....	4-5
5. SCREENING FOR STREAM AERATION.....	5-1
5.1 Air-Based Alternatives.....	5-1
5.1.1 Simple Aeration .....	5-1



5.1.2	Mechanical Aeration.....	5-2
5.1.3	Bubble Aeration.....	5-3
5.2	High Purity Oxygen Alternatives.....	5-3
5.2.1	Simple Oxygenation Using High-Purity Oxygen.....	5-4
5.2.2	Pressurized Oxygenation Using High-Purity Oxygen.....	5-5
5.3	Air Supplied Side-Stream Alternatives.....	5-6
5.4	Overview of Aeration Feasible Alternatives.....	5-7
6.	EVALUATION.....	6-1
6.1	Baseline Model.....	6-2
6.2	Alternative 1: Eliminate Pollutants in Wastewater Treatment Plant Effluents..	6-3
6.3	Alternative 2: Dam Crest Drop or Bridging (Graue Mill Dam) and Removal (Oak Meadows Dam).....	6-4
6.3.1	Oak Meadows Dam Removal.....	6-5
6.3.2	Graue Mill Dam.....	6-6
6.4	Alternative 3: In-Stream Aeration Using Air-Based Technology.....	6-8
6.4.1	Oak Meadows Golf Course Dam.....	6-8
6.4.2	Graue Mill Dam.....	6-10
6.4.3	Flood Control Reservoirs Use During Low Flow-Warm Conditions...	6-13
6.5	Alternative 4: High-Purity Oxygen.....	6-13
6.5.1	Oak Meadows Golf Course Dam.....	6-13
6.5.2	Graue Mill Dam.....	6-13
6.6	Summary of Options.....	6-16
	REFERENCES.....	R-1

## TABLES

Table 1-1	IPCB DO Standards.....	1-3
Table 2-1	Impacts of Urbanization on Channel Stability.....	2-1
Table 2-2	Municipal Wastewater Treatment Plant Discharges.....	2-8
Table 2-3	Published River Flows.....	2-8
Table 2-4	SHAP Ratings.....	2-9
Table 2-5	SHAP Scores.....	2-12
Table 2-6	Qualitative Habitat Evaluation Index.....	2-13
Table 2-7	QHEI Scores by River Mile/km.....	2-13
Table 2-8	River Dam Information.....	2-14
Table 2-9	SOD Survey Locations and Results.....	2-22
Table 2-10	DO Monitoring Locations.....	2-24
Table 6-1	Salt Creek POTW Upgrade Estimate Capital Cost for MBR and GAC Additions.....	6-4
Table 6-2	Instream Aeration at Oak Meadows Using Fine Bubble Tubing and Air.....	6-11
Table 6-3	Instream Aeration at Graue Mill Using Fine Bubble Tubing and Air.....	6-12
Table 6-4	High-Purity Oxygen Addition at Oak Meadows.....	6-14
Table 6-5	High-Purity Oxygen Addition at Graue Mill.....	6-15

## FIGURES

Figure 1-1	Study Area and Features of Interest.....	1-2
Figure 2-1	Channel Evolution Model.....	2-3
Figure 2-2	Oak Meadows Golf Course Dam.....	2-14
Figure 2-3	Left abutment, significant crack.....	2-15
Figure 2-4	Mature Tree compromising left training wall.....	2-16
Figure 2-5	View of left abutment and culvert.....	2-16
Figure 2-6	Water Surface Profile at Oak Meadows Golf Course Dam.....	2-17
Figure 2-7	Old Oak Brook Dam.....	2-18
Figure 2-8	Old Oak Brook Dam Sediment Profile.....	2-19
Figure 2-9	Graue Mill Dam.....	2-20
Figure 2-10	Graue Mill Dam Profile.....	2-21
Figure 2-11	DO Values for 2006.....	2-24
Figure 2-12	DO Values for 2007.....	2-25
Figure 2-13	DO Values for 2008 at Butterfield Rd. ....	2-25
Figure 2-14	DO Values for 2008 at Fullersburg Woods.....	2-26
Figure 2-15	DO Values for 2008 at York Rd., below Graue Mill Dam.....	2-26
Figure 2-16	Fish Biodiversity.....	2-27
Figure 2-17	Macro-Invertebrate Quality.....	2-27
Figure 2-18	Phosphorus Levels in Salt Creek.....	2-28
Figure 3-1	Baseline Stream Temperature for Salt Creek.....	3-5
Figure 3-2	Base Flow for Salt Creek.....	3-6
Figure 3-3	Travel Times in Salt Creek.....	3-7
Figure 3-4	Comparison Temperature Corrected SOD in Salt Creek.....	3-8
Figure 3-5	SOD Rates with the 3°C Increase in June Temperatures.....	3-9
Figure 3-6	Predicted vs. Measured Dissolved Oxygen for August 2007 for Salt Creek....	3-10
Figure 3-7	Predicted vs. Measured Dissolved Oxygen for July 2006 for Salt Creek.....	3-11
Figure 3-8	Baseline Dissolved Oxygen for Salt Creek.....	3-12
Figure 5-1	Mechanical Aeration Display.....	5-2
Figure 5-2	Bubble Aeration.....	5-3
Figure 5-3	Low Head Oxygenators.....	5-5
Figure 5-4	Diffuser Used for Bubble Aeration.....	5-6
Figure 5-5	Side-Stream Aeration Facility.....	5-7
Figure 6-1	Baseline Dissolved Oxygen for Salt Creek.....	6-2
Figure 6-2	Baseline Minimum D.O. vs Downstream Distance.....	6-3
Figure 6-3	Dam Removal Minimum D.O. vs Downstream Distance.....	6-5
Figure 6-4	Fullersburg Woods Footprint with Lowered Dam Elevations.....	6-7
Figure 6-5	Fullersburg Woods Footprint with Breaching Option.....	6-8
Figure 6-6	Aeration Alternative Minimum D.O. vs Downstream Distance.....	6-10
Figure 6-7	Oxygen Addition Alternative Minimum D.O. vs Downstream Distance.....	6-16

## APPENDICES

A	Reach Descriptions
B	SOD Reports
C	DO Model Inputs, Calibration, Validation and Alternatives
D	Public Meeting Reports

## **1 PROJECT BACKGROUND AND GOALS**

The 2000 National Water Quality Inventory 305(b) Report listed dissolved oxygen as one of the causes of impairment on lower Salt Creek. In October 2004, the Illinois Environmental Protection Agency (Illinois EPA) completed a Total Maximum Daily Loads (TMDL) Study for Salt Creek that developed load allocations for BOD<sub>5</sub>, ammonia nitrogen, and volatile suspended solids based on low-flow warm conditions (CH2MHill, 2004). This report concluded that a 56 percent reduction in BOD<sub>5</sub> and a 38 percent reduction in ammonia would be necessary to achieve the dissolved oxygen (DO) standards, or if one dam was removed a 34 percent reduction in BOD<sub>5</sub> and 38 percent reduction in ammonia would be necessary.

There are three dams on Salt Creek identified in the report, the Oak Meadows Golf Course Dam, the Old Oak Brook Dam, and the Graue Mill Dam located in the Fullersburg Woods Forest Preserve in Oak Brook. These dams are depicted on Figure 1-1. The impact of these dams on the DO level in 2004 was not well understood. Data on ambient DO levels as well as critical factors such as sediment oxygen demand (SOD), an important factor in DO levels at low-flow warm conditions, were limited.

Since the publication of the 2004 TMDL Report, a group of communities, publicly owned treatment works (POTWs), and environmental organizations formed the DuPage River Salt Creek Workgroup (DRSCW) to better understand the causes of degraded water quality and, in particular, to find ways to improve DO levels in Salt Creek. The focus of the DRSCW was to develop a sound database of water quality through monitoring, including the use of continuous DO probes, in conjunction with developing a calibrated dissolved oxygen water quality model from which a number of alternatives for enhancing stream DO levels could be evaluated.

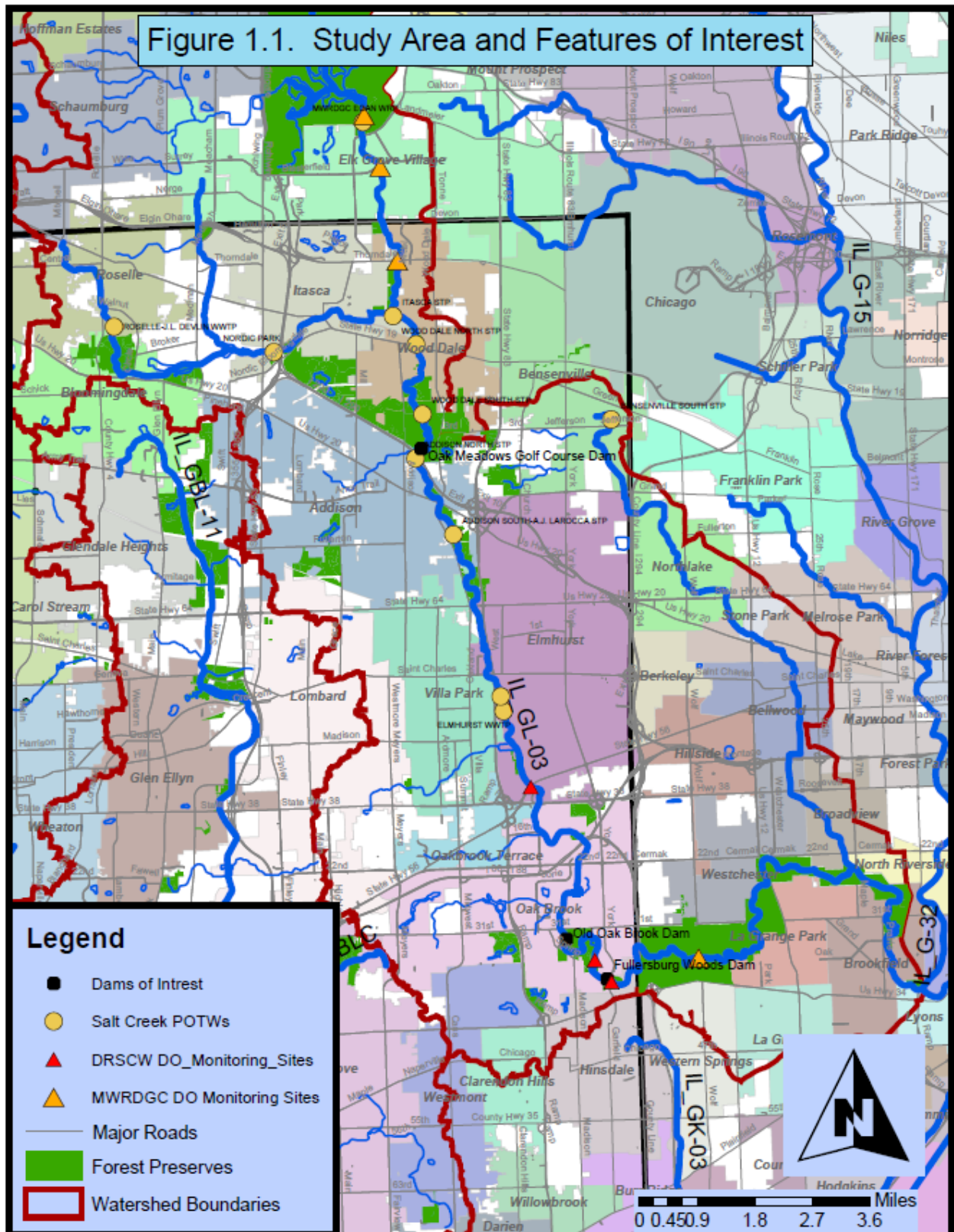
### **1.1 Project Goal**

The goal of this study is to identify the areas along Salt Creek where low DO occurs during the warmer, low flow periods, followed by the development of a calibrated DO model from which a number of alternatives are developed for addressing the low DO areas. These alternatives include the removal or modification of dams and the construction and operation of in-stream aeration projects to achieve the water quality standard for dissolved oxygen. In conjunction with this study, the DRSCW has also collected excellent biological data (fish, benthic, and habitat) which can be used along with the water quality monitoring data to address biological impairment in a holistic manner.

This study will identify:

1. Those reaches where the lowest DO levels occur during low flow-warm weather.
2. The primary cause(s) of the low DO based on water quality monitoring, sediment oxygen demand (SOD) measurements, and modeling.
3. Potential dam sites where complete removal, ‘bridging,’ or some other modification would improve minimum DO levels.

- Potential sites where stream aeration equipment would provide an opportunity to raise minimum DO levels.



5. Permitting authorities, required permits, and regulatory issues.
6. Environmental impact on water quality and stream habitat, in addition to secondary impacts and other community issues such as adjacent land use.
7. Financial impacts, including project capital costs (including sediment removal and disposal costs), operation and maintenance needs, and other costs associated with stream improvement projects.
8. Dam owners and nearby landowners affected by stream improvement projects, along with their interest in accommodating such a project, and a description of the impacts of stream improvement projects.
9. Adjacent associated construction needed as part of stream improvement projects (e.g., upstream and downstream stream bank improvements that would be necessary due to altered water levels, adjacent equipment, electrical feed, equipment access for maintenance).
10. Other aspects of stream improvement projects that may impact the feasibility of such a project.

## 1.2 Water Quality Standards

On January 24, 2008, the Illinois Pollution Control Board (IPCB) adopted revised DO water quality standards. These standards are presented in Table 1-1.

**Table 1-1 - IPCB DO Standards**

Measurement Interval	Minimum DO Standard	
	August – February	March – July
At any time	3.5 mg/L	5.0 mg/L
7 day average	4.0 mg/L	6.0 mg/L
30 day average	5.5 mg/L	n/a

Minimum DO levels occur in Salt Creek during prolonged hot, dry periods. As the water temperature rises, the daily minimum DO values become lower. From a practical perspective, any solution must address prolonged hot, dry periods that can occur in June and July. Based on in-stream monitoring, the minimum DO standard of 5.0 mg/L during June and July will be more difficult to achieve than the 6.0 mg/L weekly mean, as photosynthesis increases DO levels during the daylight hours well above 6.0 mg/L. Therefore, for the purposes of this report, achieving the minimum DO standard of 5.0 mg/L in June and July will be the basis for evaluating alternative approaches of dissolved oxygen improvements in Salt Creek.

## 2 EXISTING CONDITIONS

Before evaluating alternatives for improving the DO in Salt Creek, it is important to understand the existing stream characteristics. Factors such as stream depth, canopy cover, sediment accumulation, stream bank erosion, riparian zone composition, wetlands, stream slope, and bank heights are all important during the alternative development and evaluation process. In addition, SOD measurements have been completed and continuous DO probes have been installed at strategic locations along Salt Creek to better understand the DO profile under low-flow warm conditions.

### 2.1 Geomorphic Assessments

Natural streams are in constant dynamic equilibrium. Although imperceptible over years or decades, a stream in equilibrium moves within its floodplain both laterally and vertically over long time periods. A channel can be in balance with the hydrologic and sediment influences or can be in rapid transition as a result of changes in the watershed or within the stream corridor. Urban river systems are often in various states of disequilibrium. The development of Chicago area watersheds has significantly increased the intensity of land use. The impact of urbanization on stream systems is well documented and includes changes in the hydrology, water quality, sediment supply, and ecology. Other impacts include isolation from and reduction of available floodplain capacity and installation of road crossings and other lateral and vertical controls. Hence, urbanization can significantly increase stream instability, as shown in Table 2-1.

**Table 2-1 - Impacts of Urbanization on Channel Stability**

<b>Instability Description</b>	<b>Probable Cause</b>
Increase in erosive energy of stream	Channel Straightening – sinuous and low gradient streams become straight and steeper
Increase in velocity	Larger discharge rates due to impervious cover, culverts, drain tiles, and storm sewers
Decrease in in-stream channel roughness	Removal of riparian vegetation and in-stream woody debris
Decrease in amount and character of incoming bed load	There is more energy to move bed material than there is available bed material due to impervious cover and channel armoring
Change in geotechnical loading characteristics of the banks	Alteration of baseflow, as well as periods, levels, and timing of saturation
Change in riparian management	Deforestation and turf grass changes
Increase in stream temperatures	Loss of canopy cover

From a geomorphic perspective, Salt Creek is a disturbed system, with channel features typical of those found in large, fully built-out metropolitan areas. When the area was developed, small tributary streams were either put into pipes and buried or were confined to narrow, straightened ditches. Floodplains for these headwater channels, as well as the main channel, have been filled in or separated from waterways by large berms that concentrate flood flows into deeper narrower channels. Floodplain and drainage surfaces have been covered by pavement and storm water is now directed into storm sewers that discharge directly into creeks. Where rainfall once seeped into soils and traveled as groundwater into channels, storm water is now diverted into artificial waterways and enters the stream as runoff at a higher rate of flow. These processes lower base flows and increase flood flows, making Salt Creek a “flashy” stream, particularly in its upper reaches.

### 2.1.1 Channel Evolution

Schumm (1984) describes the evolution of stream channels (Figure 2-1) that adjust geometry in response to changes in the watershed. In essence, if a channel needs to adjust its cross sectional area, it must move through the evolution stages described below until it reaches a new, stable geometry. The Schumm system classifies streams by their place along a continuum of channel changes toward the more stable geometry. This process is common in urban systems where channels are continually adjusting in response to increasing water input, decreasing sediment load, and often significant physical alteration (channel straightening, floodplain width reduction, etc.).

It is useful to describe the stages in Figure 2-1 to understand the process. Stage I represents a stable channel configuration. As sediment load *decreases* and flood magnitude *increase*, the channel begins to erode (incise) into its bed (Stage II). The incision process is followed Stage III, lateral bank erosion as the bank heights ( $h$ ) exceed a critical height ( $h_c$ ) and collapse into the channel. Stage IV occurs when the bed begins to aggrade (deposit) and the channel banks are approximately equal to the critical stable height. The bank height will continue to decrease until a bankfull condition is achieved that is consistent with the new bankfull discharge. A new incipient floodplain will develop and vegetate as part of the final (larger) stable geometry (Stage V).

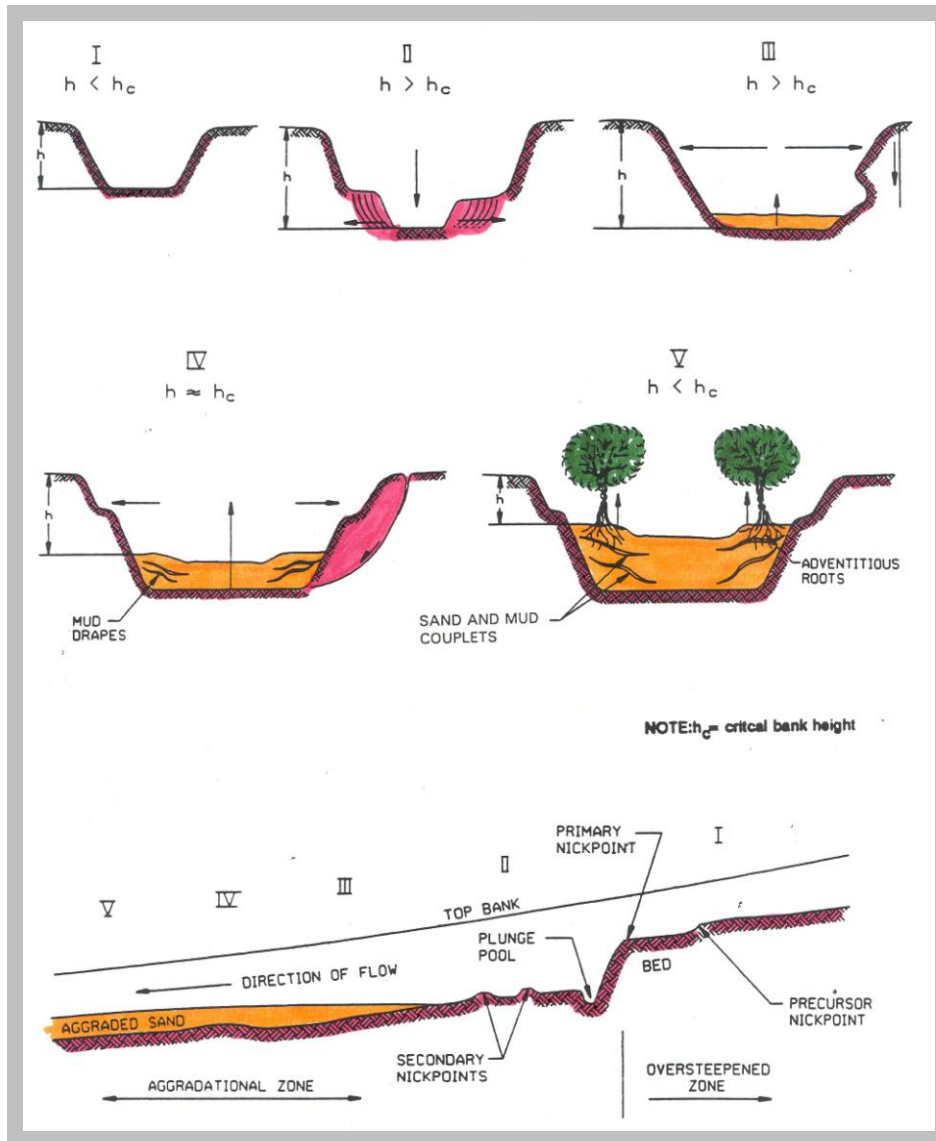


Figure 2-1 - Channel Evolution Model

### 2.1.2 Bank Erosion

Bank erosion is part of the natural processes within a stable stream and is balanced by deposition of sediment on floodplains and bars. Erosion provides the needed bed material, allows recruitment of large woody debris, and encourages channel variability. However, ‘excess’ bank failure associated with unstable riverine systems and massive failures that threaten existing infrastructure can cause unacceptable environmental impacts and consequences to private and public resources. Bank failure can generally be attributed to three basic processes (Thorne et al., 1997): subarial wasting, hydraulic scour, and mass failure. Subarial wasting is not considered to be the major driving force for Midwestern urban streambank instability and is not discussed further here.



The common result of urbanization is a significant increase in bank erosion due to hydraulic scour of the channel bed and toe of the bank. When changes in land use result in increased water velocity, streams begin to erode their bed and banks beyond the point of equilibrium. Excess hydraulic scour generally can be addressed in two ways, either by reducing channel velocity and thereby reducing erosive force, or by armoring the channel to resist the erosive force. Reduction of channel velocity can be accomplished either by increasing the area of the channel, increasing the capacity of the channel and/or floodplain, decreasing flow rates, or modifying slope through the use of grade controls. Following incision, as noted in the Schumm model above, hydraulic scour combined with mass failure can lead to extreme bank erosion.

Mass failure of the streambank is often the result of increased hydraulic scour, and/or change in riparian vegetation management associated with urbanization. There are numerous bank failure mechanisms due to various loading and resistant conditions, including differences in soil characteristics and vegetative reinforcement. Streambank soils can vary both vertically and horizontally, and can generally be classified as cohesive, non-cohesive, and composite (banks with layers of soil that have significantly different characteristics). Each of these types of streambanks presents different engineering challenges and different solutions. The equilibrium processes of scouring and deposition of soil layers within an alluvial valley can provide significant variability in the soil conditions within the valley. Hence, the type of bank material can change significantly along a stream length as the stream passes through different depositional eras.

The ditching, dredging and straightening of channels is termed *channelization*. The result of these hydrologic changes in Salt Creek has resulted in dramatic geomorphic changes. Channelization is perhaps the most common form of channel disturbance throughout Salt Creek, and its effects vary. Where wide ditches have been excavated, shear stress on the banks is relatively low, and banks are stable. Because these reaches lack sufficient energy to transport sediment through the reach, many of these over-widened stretches have aggradation problems, whereby fines such as silt and sand are deposited. Just above Butterfield Road is an extreme example of this over-widening. Channelization increases the effective slope of a stream by allowing water to travel a shorter distance, increasing velocities resulting in incision. The newly created steeper slope is unstable given the hydraulic conditions, and begins to headcut upstream until a lower slope is achieved. This often results in deep incision upstream and aggradation downstream.

Common measures to address mass failure of streambanks include decreasing the load by reducing bank height, reducing bank slope, improving drainage or planting stabilizing vegetation (to reduce pore pressure), and/or increasing the resistance to failure by geosynthetic reinforcement or revegetation.

### 2.1.3 Sediment Transport

Understanding sediment transport characteristics of a stream is very important in understanding the stream stability and characteristics. Alluvial streams within urbanizing watersheds frequently experience rapid channel enlargement. Channel response to urbanization has been described by Leopold, et al (1964), Hammer (1972), and numerous others. During the initial wave of

construction, sediment loads reaching the stream from the watershed may be elevated 10 to 100 times compared to pre-construction loads, with the attendant destabilization and sometimes flooding damages. Typically, high sediment yields during the construction phase are followed by reduced yields once infrastructure and storm sewer systems are fully built (Kondolf and Keller, 1991). However, as the fraction of the watershed covered by impervious materials increases, watershed hydrology shifts dramatically. Flow peaks become sharper, higher, and more frequent, while the sediment loads reaching the channel changes.

In the absence of bed control (e.g. bedrock outcrops in natural channels or hardened stream crossings in urbanized areas), channels typically respond by incising. When bank heights exceed a critical threshold for geotechnical stability, mass failure ensues and explosive channel widening occurs. Sediment supply changes such as local and upstream bank failure, upstream modifications etc., and transport capacity changes (channel widening, meander cutoffs, construction of additional crossings, etc.) can make a reach aggrading, in equilibrium, and degrading over time.

Sediment transport continuity describes the ability of a stream reach to transport the sediment that it receives from upstream sources. A stream reach is considered to be in equilibrium if it can transport the sediment it receives within the reach and from upstream sources to downstream reaches. A reach is considered to be degrading if its transport capacity exceeds the sediment supply (and hence the river will erode its bank and bed) and aggrading if the supply exceeds the transport capacity (leading to deposition).

## **2.2 Stream Characterization**

In general, Salt Creek can be characterized as an urban stream with low gradients and extensive channelization. Canopy cover in the assessed stretches is variable due to development, channelization activities, and widening of the stream bed. The loss of canopy cover results in higher summer stream temperatures and in some areas of Salt Creek, the establishment of excessive rooted vegetation. Flow during low flow periods is dominated by effluent from the wastewater treatment plants along Salt Creek.

The slope of Salt Creek in the critical stretches is relatively flat, with many reaches having a drop of less than 1 foot per 1,000 feet. The steepest drop occurs between River Mile 17.5 and 16.8 (28.0 and 26.9 km) below Route 83 and above the over-widened section at Butterfield Road, where a drop of 4 ft (1.2 m) occurs over a 3,000-foot (1,000 m) reach. Slope is critical as the stream velocity is influenced by the slope, and stream re-aeration is influenced by the velocity. In stretches where re-aeration is low (due to flat terrain), maintaining minimum dissolved oxygen levels becomes more difficult.

The headwaters of Salt Creek have incised in steps, with road crossings sometimes serving as grade controls, preventing further incision. Road crossings, whether bridges or culverts, can often be the cause of incision. In some cases, however, rock is placed under bridges to prevent scour of bridge pilings or abutments, and these rock riffles often act as grade control, preventing downstream headcuts from migrating further upstream. Salt Creek from Algonquin Road upstream shows a stepped incision pattern, with the deepest incision being found upstream of

Plum Grove Road. In some areas, the channel has incised more than 3 ft (1 m), and subsequent widening has created extremely large channel cross-sections. Landowners have experimented with various bank stabilization treatments including timber cribs, rock riprap, concrete rubble, and sheet piling. All of these methods are hard engineering and prevent the channel from assuming a stable cross-section. Thus the erosional energy of the stream is translated downstream to other properties.

The many road crossings and dams on Salt Creek act to impound both low flow and high flows, potentially increasing flooding. The dam at river mile 29.5 (47.5 km) floods over 2.5 miles (4.0 km) of channel, drowns the floodplain and backs water upstream for 3.5 miles (5.6 km), virtually eliminating any lotic habitat that may have existed. The dams on Salt Creek have also reduced the river's sediment transport ability by capturing sediment behind the dams. This creates a secondary situation downstream, whereby sediment-starved water erodes bed and banks and streams become armored, over-widened, and incised.

Floodplain encroachment and development is a major impact to Salt Creek, especially upstream of River Mile 10.7 (river kilometer 17.1). This is typical of most urban streams, where parkland and natural openspace is preserved in the downstream reaches and the headwaters are fully developed. This is the reverse of what is required for streams to function geomorphically and ecologically. Because the headwaters are where hydrology and sediment transport originate, development of these areas degrades the stream in its headwaters. Residential development has the biggest impact on Salt Creek's headwaters and continues to confine the channel down to River Mile 22.0 (35.2 km). Downstream of Interstate Highway 290 (River Mile 22.9 (36.6 km)), the floodplain is occupied by numerous detention basins. Between river distances 20 and 30 (32 and 48 km), there are 11 such large detention ponds adjacent to the stream channel. All of these encroachments limit the ability of the stream to meander. If a restored stream is to be allowed to function geomorphically, it must be allowed to meander across its floodplain. This requires space, and the limits of meandering must be established. In most cases, however, the stream is bordered by infrastructure and is then hard armored to prevent meandering.

The riparian area of Salt Creek is largely wooded, but varies in width from 0 feet to 1,000 feet. As with most urban rivers, stream banks and riparian areas in residential or light industrial neighborhoods are often armored and most trees are removed. The Forest Preserve system has retained the floodplain forest community in many reaches. Eight major parks and golf courses along Salt Creek represent a significant impact to the riparian corridor, as they have removed most if not all of the riparian trees from the stream banks. Often these reaches are accompanied by hard armoring, either by A-jacks or riprap.

Hard armoring of stream banks is prevalent along Salt Creek and presents a major impact to the aquatic ecology and geomorphology of the stream. Hard armoring is sometimes required to protect infrastructure such as roads and buildings from eminent risk of failure due to eroding banks. However, much of the hard armoring encountered was in the form of riprap or A-jacks. A-jacks can also prevent the movement of amphibians and other aquatic species. Animals, such as turtles and frogs, depend on banks for upland access, reproduction, and breeding. A-jacks prevent any such use of banks. Installation of these practices was observed upstream of constricting road crossings and dams, on the inside of meander bands, and along banks that were

not eroding, in some cases with a bank full height of less than 3 ft (1 m). A-jacks have also been installed in long reaches of forest preserve land where no infrastructure is present.

Observation of stable reaches throughout Salt Creek point to the importance of woody vegetation for stability and both artificially and naturally stable reaches repeatedly show that small diameter material such as cobble and gravel are often adequate to provide toe stability.

Invasive species such as buckthorn and garlic mustard have taken over many sections of floodplain forest and can influence the geomorphology of the system by increasing floodplain roughness. Normally, floodplain forests have little understory vegetation and flood flows can pass freely between large trees. Buckthorn and garlic mustard add significantly to floodplain roughness, basically filling in the spaces between trees. Eventually, this increased growth may force more water down the narrow channel width.

The lower reaches of Salt Creek, below the Graue Mill Dam where the stream is allowed to meander slightly, resemble more natural stream channels with regular riffle-pool sequences, large woody debris inputs, depositional bars and scour at meander bends.

### **2.3 Flow Data**

The total drainage area in the Salt Creek Basin is approximately 147 square miles (380 km<sup>2</sup>), extending through Cook and DuPage Counties. The creek originates in northern Cook County as the outlet for Busse Lake within the Village of Inverness, flows south into DuPage County through Oak Brook, and turns east and flows into Cook County, discharging into the Des Plaines River in Lyons, IL. The total stream length is approximately 45 miles (72 km). There are two main tributaries on the lower portion of Salt Creek<sup>1</sup>, Spring Brook and Addison Creeks. In the segment from Spring Brook Creek to the rivers mouth, there are seven sewage treatment plants, and the MWRDGC John Egan Water Reclamation Plant is located upstream. From a DO perspective, the industrial dischargers were not deemed to be contributing deoxygenating waste to Salt Creek. These point source discharges are presented in Table 2-2, and the locations were depicted on Figure 1-1.

---

<sup>1</sup> Lower portion here is understood as the portion south of the Busse Woods Dam in Schaumburg

**Table 2-2 – Municipal Wastewater Treatment Plant Discharges**

<b>Discharger</b>	<b>River Mile (km) from mouth</b>
Elmhurst Wastewater Treatment Plant	17.8 (28.6)
Salt Creek Sanitary District Treatment Plant	17.9 (28.8)
Villa Park Wet Weather Treatment Plant	18.0 (29.0)
Addison South A.J. Larocca STP	20.9 (33.6)
Addison North STP	22.6 (36.4)
Wood Dale South STP	25.3 (40.7)
Itasca STP	25.7 (41.4)
MWRDGC John Egan Water Reclamation Plant	29.6 (47.6)

Selected published flows for Salt Creek are listed in Table 2-3.

**Table 2-3 - Published River Flows**

<b>Location</b>	<b>7-Day 10-Year Low Flow, cfs</b>	<b>Harmonic Mean Flow, cfs</b>
Above Elmhurst	36	55
Below Elmhurst	45	74
Western Springs	38	81
Above Addison Creek	36.5	84
Entering Des Plaines	37	100

Combined sewer overflows (CSOs) and sanitary sewer overflows (SSOs) contribute to lower DO levels at low flow conditions through historic deposition, which was measured as part of the 2006 and 2007 SOD studies (HDR and Huff & Huff, 2006 and HDR and Huff & Huff, 2007). The wet weather DO impacts of these utilities are not included as part of this study.

## 2.4 Reach Descriptions

In the 2006 303(d) List, two segments of Salt Creek were listed as DO impaired, Segment GL-03 and GL-19. Segment GL-03 starts where Spring Brook Creek enters at River Mile 28.3 (45.3 km), just north of Irving Park Road, and Segment GL-19 is the final 3.1 miles (5.0 km) of Salt

Creek from the junction with Addison Creek to the Des Plaines River. The final stretch of Salt Creek has low DO levels attributed to the poor water quality from Addison Creek.

The Illinois EPA Qualitative Stream Habitat Assessment Procedure (SHAP) was utilized to describe each stream segment based on the observations collected during the reconnaissance. The SHAP index includes factors for bottom substrate, deposition, substrate stability, canopy cover, pool substrate characterization, pool quality, pool variability, canopy cover, bank vegetation, top of bank land use, flow-related refugia, channel alteration, channel sinuosity, width/depth ratio, and hydrologic diversity. Based on the subjective evaluation for the aforementioned factors, a SHAP score is determined. These values correspond to the ratings shown in Table 2-4.

**Table 2-4 - SHAP Ratings**

<b>Rating</b>	<b>SHAP Score</b>
Excellent	≥ 142
Good	141 to 100
Fair	99 to 59
Poor	< 59

Channelization, lack of canopy cover, effluent dominated low-flows, and other factors all contribute to the vegetative growth and subsequent lower early morning DO levels.

A reconnaissance of Salt Creek was completed on October 13, 2005, during a period of low-flow conditions, from the Addison North Wastewater Treatment Plant (River Mile 22.6 (36.2 km)) to Graue Mill (River Mile 10.7 (17.1 km)). Appendix A includes Figures 2.1 to 2.8 describing the observations from a float trip through each segment. A description of each segment is provided below:

Addison N WWTP (River Mile 22.6 (36.1 km)) to Addison S WWTP (River Mile 20.9 (33.6 km))

This 1.7 mile (2.7 km) stretch has a SHAP score of 60, or fair aquatic habitat. Water depth ranged from 0.6 to 2 ft (0.2 m to 0.6 m), with predominantly a silty-sand substrate until below Lake Street (River Mile 21.7 (34.7 km)) where the depth increased to 3.0 to 3.3 ft (1.0 to 1.1 m). The substrate in this pool area is predominantly silt. A concrete “curb” dam is present at River Mile 22.1 (35.4 km), just upstream of Lake Street, and log jams are backing up flow at Lake Street. Wildlife observed in this stretch included great blue heron, mallards, king fisher, and beaver. Good floodplain habitat existed through much of the reach with shallow bank heights and moderate stream bank erosion. The creek has some meanders in this stretch. North of Lake Street, the riparian zones were wooded with fair to good canopy cover.

Addison South WWTP (River Mile 20.9 (33.6 km)) to North Avenue (River Mile 19.5 (31.4 km))

This 1.4 mile (2.2 km) stretch has water depths ranging from 0.3 ft (0.1 m) where stream bottoms vary from firm clay to silty sand, to pools up to 5 ft (1.5 m) deep with firm clay bottoms.

Immediately below the Addison South WWTP the water depth was 1ft (0.3 m), with a gravel bottom. A log jam in this location had an accumulation of floating duckweed. Stream banks were approximately 5 ft (1.5 m) high with virtually no adjoining wetland areas. Just above North Avenue, soft sediment, 6 inches in depth (15 cm) was present on the inside of the bend, decreasing to 2 inches (5 cm) of soft sediment in the center. Canopy cover in this stretch was relatively good.

The SHAP score improved in this stretch to 96; however, still in the “fair” habitat range. This stretch had fair canopy cover, several riffle run complexes and undeveloped riparian zones. This stretch was relatively unchannelized and had good stream sinuosity and habitat diversity. Salt Creek passes through the Cricket Creek Forest Preserve north of North Avenue.

North Avenue (River Mile 19.5 (31.4 km)) to Route 83 (River Mile 18, 1 (29.1 km))

This 1.4 mile (2.2 km) reach includes some long channelized segments and passes between a former active quarry currently used by DuPage County for flood control and an asphalt plant. A turbid discharge was present adjacent to the asphalt plant. Below the railroad bridge (River Mile 18.9 (30.4 km)) to Illinois Route 83 there is a good series riffles and the drop in elevation is more pronounced than the remainder of the creek. There is an oxbow cutoff just above St. Charles Road (River Mile 18.3 (29.4 km)). South of North Avenue the water depth starts out between 2 and 2.9 ft (0.6 and 0.9 m), with up to 3.9 inches (10 cm) of soft sediment, diminishing to 1 inch (2.5 cm) of soft sediment in the channelized section without canopy adjacent to the quarry.

The SHAP score in this reach declined to 91, still in the “fair” habitat range. Wildlife observed included great blue heron, king fisher, mallards, and beaver. In-stream habitat was fair north and south of the gravel operation. Although the stream was more channelized than the previous stretch, habitat diversity and canopy cover were good, outside of the stretch adjacent to the quarry.

Illinois Route 83 (River Mile 18.1(29.1 km)) to Illinois Route 56 (River Mile 16.1 (25.9 km))

The riffles continue below Illinois Route 83 in 1ft to 2 ft (0.3 to 0.6 m) of water over a gravel substrate. A large storm water outfall is present at River Mile 17.9 (28.8 km) and two WWTP outfalls (Salt Creek and Elmhurst) are present at River Mile 17.8 and 17.9 (28.6 and 28.8 km), respectively. Water depth generally continues between 1ft to 2 ft (0.3 and 0.6 m) with a firm bottom. An additional riffle exists at approximately River Mile 17.2 (27.7 km) and a double sheet pile dam exists at River Mile 16.9 (27.2 km) by Jackson Street. Salt Creek narrows above this dam. Below the dam, water depth increases to an average 2.9 ft (0.9 m) with 1 inch (2.5 cm) of sandy silt sediment over stiff clay.

Evidence of beaver and muskrat activity is present below this dam for the next 0.5 miles (0.8 km). Salt Creek above Illinois Route 56 (Butterfield Road) opens into a long, wide area, 0.9 to 2 ft (0.3 to 0.6 m) in depth with virtually no canopy cover. At low flow, the stream velocity is negligible and rooted vegetation has taken hold in the bottom. High levels of aquatic vegetation are generally considered detrimental to overall DO level, as respiration at night depletes the DO. Sediment depths are 2.9 to 3.9 inches (7.5 to 10 cm) along both shorelines. Closer toward Illinois Route 56, the vegetation in the stream begins to subside and stream bank heights increase to 10.2 to 15.1 ft (3.1 m on the west bank and 4.6 m on the east bank).

The SHAP score for this stretch, 78, remains in the “fair” range for habitat. The habitat diversity (riffle/run/pool), canopy cover and in-stream habitat are good in the northern half of this stretch. The southern portion is more channelized with poor canopy cover and poorly vegetated riparian zones.

Illinois Route 56 (River Mile 16.1 (25.9 km)) to Interstate Route 88 (River Mile 14.3 (23.0 km))

This 1.8 mile (2.9 km) stretch is through developed property in Oak Brook. Below Illinois Route 56, the wide stream run continues, ranging in depth from 0.9 to 2 ft (0.3 to 0.6 m) with a silty gravel substrate. The canopy improves below Illinois Route 38 (River Mile 15.7 miles (25.3 km)), and the creek narrows, and deepens to 2.6 to 3.3 ft (0.8 to 1.0 m). Velocities noticeably increase and the substrate changes to cobbles and sand. Stream bank stabilization has been installed below Illinois Route 38 but further downstream serious bank erosion exists.

Salt Creek turns east at River Mile 15.1 (24.3 km), and the water depth deepens to 6 to 7.3 ft (1.8 to 2.2 m). This pool is heavily channelized and has a sand and gravel substrate. As Salt Creek approaches Interstate Route 88 it becomes shallower (1.2 m).

The SHAP for this segment declines to 69, still in the “fair” habitat range. Similar to the last stretch, stream habitat quality is greater on the north end. Below Illinois Route 38, the stream has fair canopy cover and wooded riparian zones providing filtration. Near Interstate Route 88, the in-stream habitat decreases as Salt Creek becomes a large pool with little habitat diversity.

Interstate Route 88 (River Mile 14.3 (23.0 km)) to Graue Mill Dam (River Mile 10.7 (17.2))

This 3.6 mile (5.8 km) stretch has water depth varying from 1.0 to 5.9 ft (0.3 to 1.8 m). The northern part of this section flows through two golf courses. Between Interstate Route 88 and Cermak Road, Salt Creek is 2.6 ft (0.8 m) deep with a mud bottom 2 to 5.9 ft (0.6 to 1.8 m) deep with gravel substrates. As Salt Creek enters the golf course, it deepens from 2.9 to 5.9 ft (0.9 to 1.8 m) in depth and the banks are lined with caged rocks. The bottom is generally firm through the golf course. The stream then enters the Fullersburg Woods Forest Preserve south of 31st Street. The Old Oak Brook Dam is located below 31st Street at River Mile 12.5 (20.1 km). This section has soft sediment to the north and hard clay to the east/south. Serious bank erosion was noted south of 31st Street River Mile 12.3 (19.8 km). The last 1.6 miles (2.4 km) of this portion of Salt Creek is a long pool with clay bottoms upstream transitioning to softer sediments downstream near the Graue Mill Dam (River Mile 10.7 (17.2 km)). The last 330 ft (100 m) of this segment had 1 ft (0.3 m) of sediment under 4.9 ft (1.5 m) of water.



The SHAP for this segment was 55, indicating poor habitat quality. The section had poor habitat diversity, scattered canopy and was mostly deep pools. However, areas with good riparian zones were present south of Butler National Golf Course and within the forest preserves. It should be noted that the only in-stream wetlands were noted at the south end of this section.

Below the Graue Mill Dam, DO impairment is identified only in the final 3.1 miles (5 km), where Addison Creek joins Salt Creek, and the float trip did not include the stretch below the Graue Mill Dam.

## 2.5 Habitat Summary

The SHAP scores and the habitat conditions for each segment are summarized in Table 2-5. Optimal Scores are more than 160 but may range to a maximum of 200.

**Table 2-5 - SHAP Scores**

Stream Reach	Assessment Score SHAP	Limiting Habitat Conditions
Addison N WWTP to Addison S WWTP River Mile 22.6-River Mile 20.9, (36.1 – 33.6 km)	60 (Fair)	Moderate streambank stabilization
Addison South WWTP to North Avenue River Mile 20.9-River Mile 19.5, (33.6 – 31.4 km)	96 (Fair)	Undeveloped riparian zones
North Avenue to Route 83 River Mile 19.5 –River Mile 18.1, (31.4 – 29.1 km)	91 (Fair)	Channelized
Illinois Route 83 to Illinois Route 56 River Mile 18.1 – River Mile 16.1, (29.1 – 25.9 km)	78 (Fair)	Poor canopy / riparian zone (over channelized)
Illinois Route 56 to Interstate Route 88 River Mile 16.1- River Mile 14.3, (25.9 – 23.0 km)	69 (Fair)	Poor habitat diversity, scattered canopy, deep pools (over channelized)
Interstate Route 88 to Graue Mill Dam River Mile 14.3 –River Mile 10.7, (23.0 – 17.2 km)	55 (Poor)	Poor habitat diversity, scattered canopy

In addition, the qualitative habitat evaluation index (QHEI) was determined at eight locations on Salt Creek. The QHEI provides a quantitative assessment of physical characteristics of a stream and represents a measure of in-stream geography. The seven variables which comprise this index and the best possible score for each are shown below. The maximum total QHEI score is 100 and is broken down in Table 2-6. The Salt Creek QHEI scores by river km are shown in Table 2-7. . While QHEI and SHAP rating measure similar metrics, they use different scoring systems and are not directly comparable to each other. A QHEI score of 60 or above would designate full support to warm water streams without use impairment.

**Table 2-6 - Qualitative Habitat Evaluation Index**

<b>QHEI Component</b>	<b>Point Value</b>
Substrate type and quality	20
In-stream cover type and amount	20
Channel morphology – sinuosity, development, channelization stability	20
Riparian zone – width, quality, bank erosion	10
Pool quality – maximum depth, morphology, current	12
Riffle quality – depth, substrate stability, substrate embeddedness	8
Map gradient	10

**Table 2-7 - QHEI Scores by River Mile/km**

<b>River Mile (km)</b>	<b>QHEI Score</b>
27.0 (43.4)	67.5
25.0 (40.2)	58.5
22.8 (37.0)	46.5
18.3 (29.5)	84.0
16.5 (26.5)	71.5
13.7 (22.0)	47.5
12.7 (20.4)	40.5
11.0 (17.7)	39.5

The Ohio QHEI scores for similar river miles tend to rate the upriver segments higher than the Illinois SHAP ratings, but the downriver segments are similar in their categorization

## **2.6 Dam Site Investigations**

Removal or reconfiguration of dams can increase dissolved oxygen in waterways. The three dams on Salt Creek were investigated to gain an understanding of their characteristics. The names, locations, and river locations (based on the GIS model) of the three dams on Salt Creek are listed in Table 2-8, and were depicted in Figure 1-1.

**Table 2-8 - River Dam Information**

Name	Year Built	River Mile (km)	Bounding Bridges		Nearest Town
			Upstream	Downstream	
Oak Meadows Golf Course Dam		22.9 (36.8)	Elizabeth Dr	I-290	Wood Dale
Old Oakbrook Dam		12.5 (20.1)	Oak Brook Rd / 31 <sup>st</sup> St	Fullersburg Woods Forest Preserve Foot Bridge	Oak Brook
Graue Mill Dam at Fullersburg Woods		10.7 (17.2)	Fullersburg Woods Forest Preserve Foot Bridge	York Rd	Oak Brook

The river distances reported in the above table and throughout this report were generated from GIS data for Salt Creek, supplied by DuPage County. This GIS model closely follows the existing stream centerlines, and as a result, is different than river linear units published by others. The length of stream is critical for evaluating water quality, so the most accurate representation of this parameter as generated by the GIS model was used for this study.

**2.6.1 Oak Meadows Golf Course Dam**

The Oak Meadows Golf Course Dam is owned by the Forest Preserve District of DuPage County.



**Figure 2-2 - Oak Meadows Golf Course Dam**

A survey of the dam and channel profile was conducted as was a characterization of the amount of deposited material upstream of the dam during a field visit. Joe Reents, the Oak Meadows Golf Course Superintendent, was present on site. He indicated that the structure was used historically to facilitate the collection of irrigation water. However now the course has constructed a gravity-fed pond to accomplish this task and the dam is no longer needed for this purpose.

The dam spillway appears to be an all concrete structure. The structure is 30.2 ft (9.2 m) wide (between abutment edges) with about 2ft (0.6 m) of head at normal flow. The abutments are 2ft (0.6 m) thick concrete walls with a mixture of materials used as fill. The dam appeared to be in a slightly degraded condition. The left abutment facing downstream was clearly leaning downstream, and significant cracks have developed in the concrete (Figure 2-3). Previous measures had been taken to correct the problem using reinforcing steel tie rods anchored to the upstream abutment wall. The same problem and mitigation measures occurred in the right abutment but the wall did not appear to be leaning.

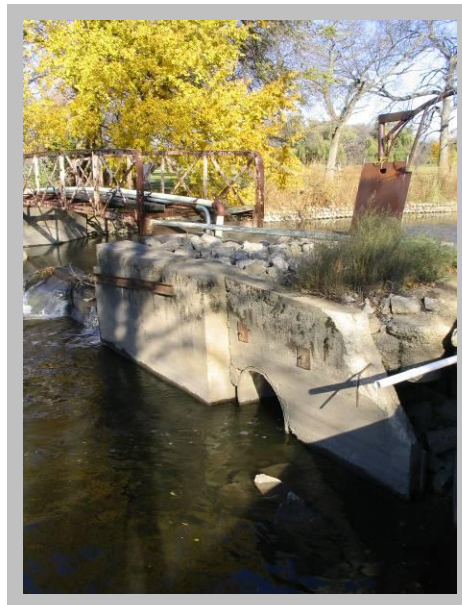
There is a 2.9 ft (0.9 m) culvert pipe located on the left side of the structure which was clogged on the day of survey with debris. This pipe can provide the means to lower the water surface below the weir elevation of the structure, assuming the capacity is not exceeded by the discharge of the creek at the time.



**Figure 2- 3 - Left abutment, significant crack**

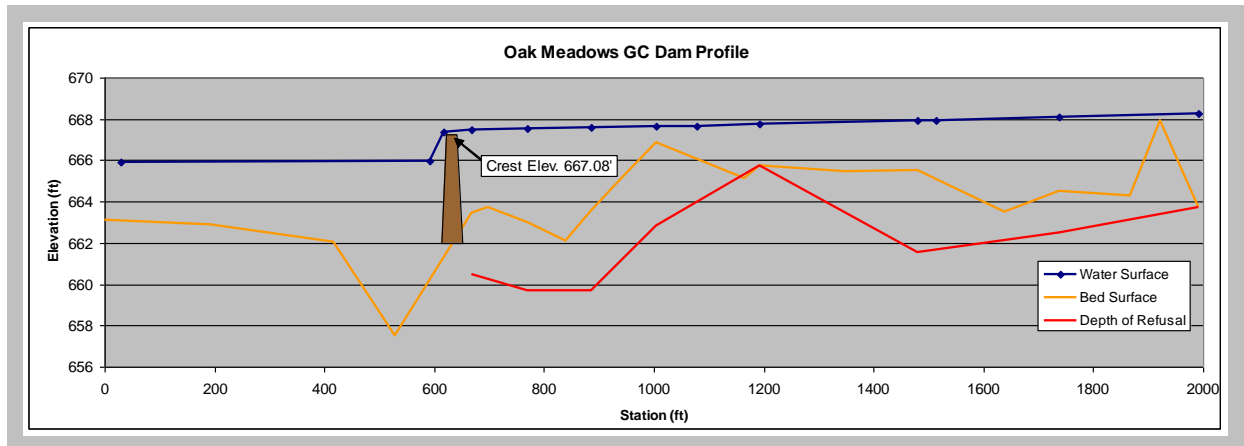


**Figure 2-4 - Mature Tree compromising left training wall**



**Figure 2-5 - View of left abutment and culvert, the steel gate can be seen in the upper right**

An investigation into the amount of sediment upstream of the dam indicated an average of about 2 ft (0.6 m) of material in the channel. A total of nine cross sections were taken beginning just upstream of the dam and extending upstream. Detailed cross sections and locations can be seen in Appendix B. A profile of the survey through the structure is depicted in Figure 2-6.



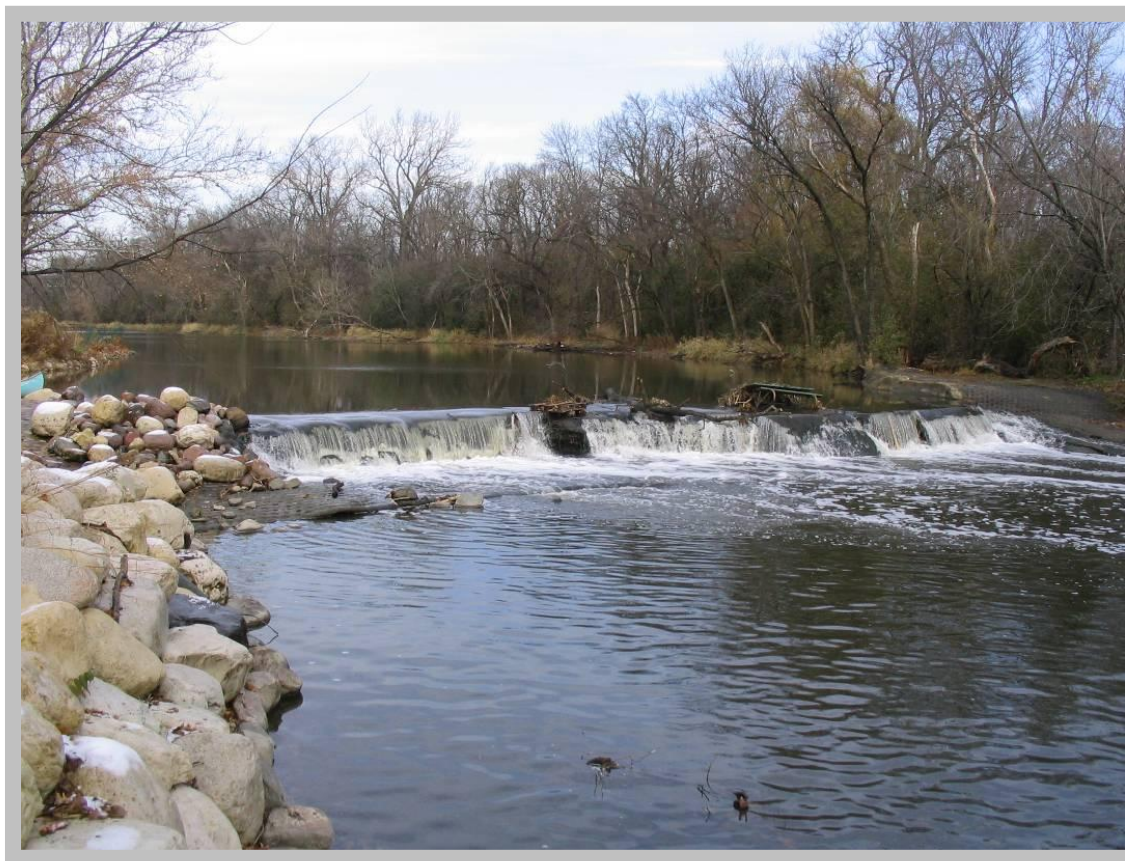
**Figure 2-6 - Water Surface Profile at Oak Meadows Golf Course Dam**

Sediment has accumulated in areas of low velocity within the stream and is not uniform in its distribution. All of the material consists of semi-consolidated fines. Storage of material within the small impoundment is still occurring as evidenced by the deposition of material in front of recently installed A-jack bank protection measures.

Because of the low elevation of the structure, the hydraulic impacts to storm water storage during flood events are expected to be minor. However, at low flows the dam maintains a fairly constant pool elevation upstream of the structure that persists for quite a distance because of the low gradient.

### 2.6.2 Old Oak Brook Dam

The Old Oak Brook Dam is reported to have been constructed in the 1920's by Paul Butler to maintain an aesthetic pool through his property holdings during low flow periods on Salt Creek. The dam is now owned by the Village of Oak Brook. Hydraulic studies conducted by Christopher Burke Engineering in 1989 indicated that the dam provides little, if any, mitigation during flood events. Further, residents report that the dam frequently becomes submerged completely during flood events.



**Figure 2-7 - Old Oak Brook Dam**

Removal of the structure was investigated in 1989. A letter from the Butler National Golf Course (upstream of the dam) indicated a desire to leave the dam in place and preserve water levels through the golf course. No other discussion on the merits or detractors of removal was found.

The original structure of the Oak Brook Dam underwent major rehabilitation approximately 20 years ago. There are two main spillway components - the fixed elevation spillway and a gated “emergency” spillway. The gated spillway section consists of two steel vertical slide gates rehabilitated in 1992. The primary spillway is 65 ft (19.8 m) wide, with about 3 ft (1 m) of head during normal flow, and consists of grouted stone with a concrete cap (no information was found on when the concrete cap was applied). The condition of the cap could not be determined on the day of the survey. Areas of the grouted stone spillway have eroded on the downstream face, leaving an irregular geometry. A report by STS Consultants indicated a concrete filled fabric-form mat had been applied to the upstream face of the structure in the early 1980’s. The left and right retaining walls consist of grouted stone and reinforced concrete overlain to a larger extent by concrete filled fabric-form mats.

Seven cross sections were sampled upstream of the dam to quantify the amount of sediment upstream. An average of about 1 ft (0.3 m) of material was found upstream of the dam, with the

largest accumulation just upstream of the left retaining wall. It is not known how often the sluice gates are opened on the structure but sediment upstream of this inlet was minimal, while downstream, fines had accumulated in the sluice gate channel. Most of the material immediately upstream of the dam was cohesive fines but the sediment quickly coarsened to sands upstream near the 31<sup>st</sup> Street Bridge. There was not an excessive amount of material accumulated behind the dam.

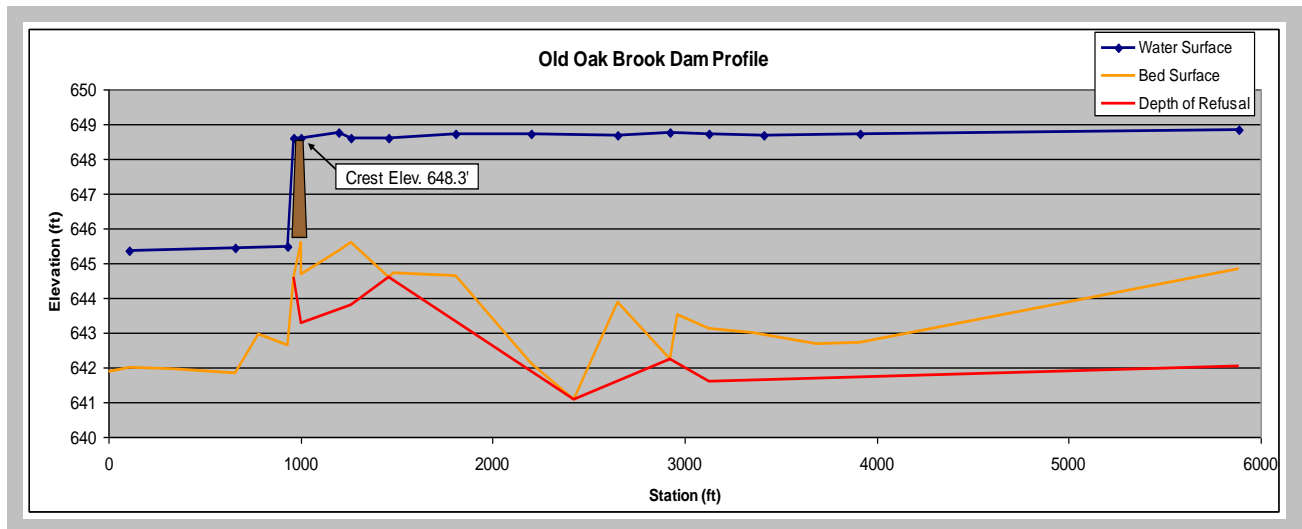


Figure 2-8 - Old Oak Brook Dam Sediment Profile

Hydraulic computations compiled by a number of studies indicate that the backwater effect of the dam stretches up to approximately 31<sup>st</sup> Street during small flood events (less than 10 year event) and 22<sup>nd</sup> street during events higher than a 10 year event. The storage provided by the dam is minimal.

### 2.6.3 Graue Mill Dam

There is no information on the original structure constructed in the 1850's at the site. The site was purchased by the DuPage Forest Preserve District in 1933 and in 1934 the Civilian Conservation Corps built the existing concrete structure that stands on the site today. The dam has a crest length of 132 ft (40.3 m), standing 6.2 ft (1.9 m) in height. The purpose of this construction was power generation. A side stream mill race is also present, which was used to house the wheel at Graue Mill. In 1991, the Forest Preserve District retained Harza Engineering Company to design a dewatering gate on the North side of the dam which allows for periodic drawdown for maintenance and inspection.





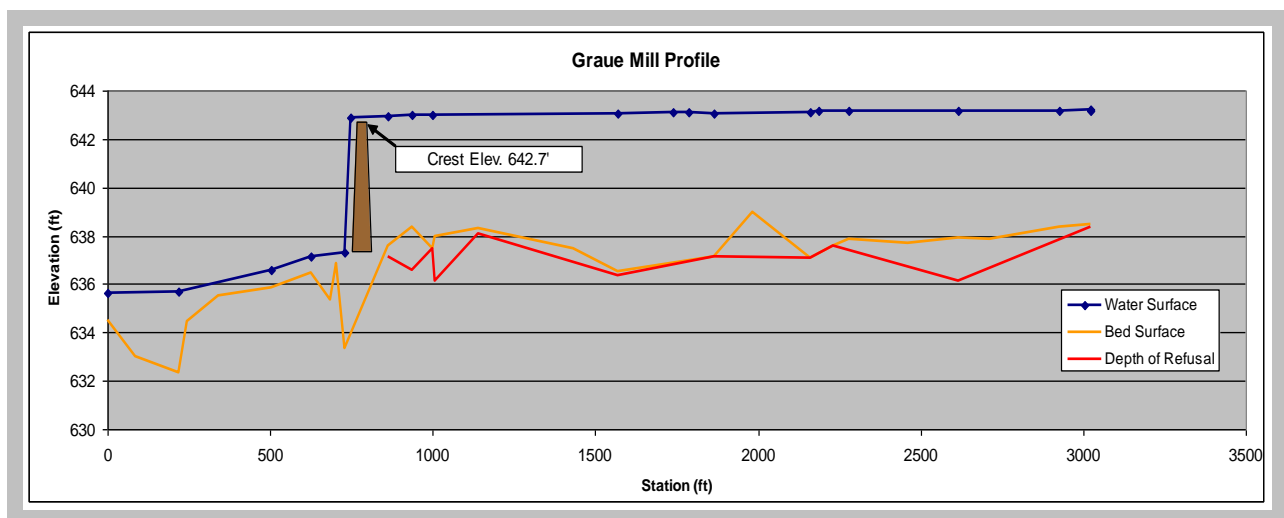
**Figure 2-9 – Graue Mill Dam**

The DuPage County Forest Preserve District gives a detailed and exhaustive account of the structure of the dam which is summarized below from a 1991 Maintenance Plan.

- *Concrete Spillway:* The concrete wall is 2.9 ft (0.9 m) thick supported by a 23 ft (7 m) wide concrete footing. An 8.8 ft (2.7 m) sheet pile wall is installed 9.5 ft (2.9 m) upstream of the concrete footing. The walls key into the earthen abutments on both sides. A 10.2 ft (3.1 m) long concrete stilling basin prevents erosion on the downstream side of the dam.
- *Earthen Abutments:* Both abutments are built on a 19 ft (5.8 m) thick layer of hard clay overlain by (3.1 m) of dense sand, 2.9 ft (0.9 m) of hard clay, and finally 5.9 ft (1.8 m) of topsoil on the North abutment, or 4.9 ft (1.5 m) of topsoil over 2 ft (0.6 m) of dense silt on the South. Tests for seepage conducted by Harza were negative for both abutments.
- *Mill Race Channel and Sluice Gate:* the Mill Race is 10.1 ft (3.1 m) wide by 210 ft (64.1 m) long and was used to power the 18 ft (5.5 m) wheel used at Graue Mill. Water control is provided by a sluice gate.

- **Dewatering Slide Gates:** 9.8- 14.5 ft (3 - 2.1 m) wide by 3.9 ft (1.2 m) high stainless steel slide gates comprise the dewatering portion of the dam. The gates are housed in a reinforced concrete structure located on the North side of the dam.

Eight cross sections were taken above the Graue Mill Dam; detailed information can be viewed in Appendix B and summarizes in Figure 2-10. There is generally 1 to 2 ft (0.3 to 0.6 m) of deposition along the channel margins with often little to no deposition in the thalweg of the channel. This lack of material is likely due to the impact of a dredging project accomplished in the late 1990s. The channel regains its natural thalweg of coarse material approximately 365 m upstream of the dam. The material that is being transported by the stream is depositing in a point bar just downstream of the final bend in the Fullersburg Woods property, starting approximately 700 ft (220 m) above the dam.



**Figure 2-10 – Graue Mill Dam Profile**

The hydraulic impacts of the dam reach through the Forest Preserve District Property upstream but do not extend above the Old Oak Brook Dam. The complete removal of the Graue Mill Dam would result in reducing the flood elevation by approximately 1 ft (0.3 m) for the 100 year event between the Graue Mill Dam and diminishing toward the Oak Meadows Dam, according to previous calculations performed by the Forest Preserve District (prior to the new updated FEQ model). In terms of storm water storage, the reservoir provides little capacity and a general consensus among past studies indicates the dam has little value in flood mitigation.

## 2.7 Flood Control Reservoirs

DuPage County Division of Stormwater Management operates two flood control reservoirs along the main stem of Salt Creek, the Wood Dale Itasca Reservoir at River Mile 42.4 (68.2 km) and the Elmhurst Quarry Flood Control Facility at River Mile 17.6 (28.3 km). The Wood Dale Itasca Reservoir has capacity for 1,775 acre-ft (578 million gallons). The Elmhurst Quarry Flood Control Facility has capacity for 8,300 acre-ft (2,700 million gallons). Aeration of the water

pumped back into Salt Creek is provided by a cascading entrance back into the creek at Elmhurst. Although not evaluated as part of this study, dewatering both of these reservoirs during low flow-warmer conditions would improve the DO levels within the creek from the increased flow and cooler temperatures of this water.

## 2.8 Sediment Oxygen Demand (SOD) Field Measurements

One of the inputs into a DO model is the Sediment Oxygen Demand, which can be highly variable as the stream geometry and slope changes. To provide these data, SOD rates were measured in situ in the summer of 2006 and at additional sites in the summer of 2007. The complete reports are contained in Appendix B.

**Table 2-9 - SOD Survey Locations and Results**

<b>Year Sampled</b>	<b>River mile (km)</b>	<b>Location</b>	<b>Average SOD (g/m<sup>2</sup>/day) - Temp. Corrected to 20 °C</b>
2007	23.0 (37.0)	North of Oak Meadows Dam/in Golf Course	<b>0.50</b>
2007	22.9 (36.8)	North of Oak Meadows Dam/in Golf Course	<b>2.27</b>
2007	22.8 (36.7)	South of Oak Meadows Dam/north of I290	<b>0.84</b>
2007	22.7 (36.5)	South of Oak Meadows Dam/south of I290	<b>0.19</b>
2006	21.0 (33.8)	Downstream of Addison S WWTP at Fullerton	<b>0.64</b>
2006	19.5 (31.4)	Downstream of North Ave., center of stream bed	<b>0.47</b>
2006	16.2 (26.0)	Butterfield Rd, between the two bridges, east bank	<b>2.31</b>
2006	13.9 (22.4)	Upstream of Cermak, Route 22	<b>1.02</b>
2007	12.7 (20.4)	Above (North) of 31 <sup>st</sup> St	<b>1.19</b>
2007	12.5 (20.1)	Downstream of 31 <sup>st</sup> St, above Old Oak Brook Dam	<b>1.20</b>
2006	12.5 (20.1)	Downstream of 31 <sup>st</sup> St, above Old Oak Brook Dam	<b>1.38</b>
2007	12.2 (19.6)	Spring Rd Salt Creek junction (north of road)	<b>0.91</b>
2007	11.4 (18.3)	Northern Fullersburg Woods Impoundment	<b>2.09</b>

2006	11.1 (17.9)	Footbridge at Fullersburg Woods	<b>2.52</b>
2007	11.0 (17.7)	Southern Fullersburg Woods Impoundment	<b>1.76</b>
2006	10.8 (17.4)	Upstream of Graue Mill Dam	<b>1.90</b>
2007	10.7 (17.2)	Upstream of Graue Mill Dam	<b>2.70</b>
2007	10.6 (17.1)	Downstream of York Rd	<b>1.79</b>
2007	10.1 (16.3)	Wide Channel north of Office Park	<b>1.36</b>
2006	7.9 (12.7)	Downstream (East) side of Wolf Rd	<b>3.59</b>

A bottom substrate composed of fine-grained sediments (clay, silt and sand) is conducive to measuring SOD; coarse materials (gravel, cobbles and boulders) are not because it is difficult to achieve a seal on the bottom of the chamber. High SOD rate is generally associated with a high organic content of the sediment. Slow moving reaches of the river are areas where fine-grained, organic sediments are likely to be found. When the field crews arrived at each station, the river bottom was viewed or probed to estimate the percent bottom coverage of fine-grained sediment. The width and depth of the river were also measured and recorded. The fine-grained sediment area was identified as a suitable location for deployment of SOD measurement chambers.

Elevated water temperature was preferred for these measurements to reduce the modeling uncertainty associated with applying a temperature adjustment coefficient based on the literature. Field measurements were performed on five days during a period when there was no precipitation on that day and the preceding day. On each day of the field survey, SOD was measured at two to three stations. Water temperature ranged from 23.3°C to 28.8°C with an average of 25.1°C. Table 2-10 presents the SOD results for the two summers corrected to a constant 20°C ambient water temperature.

With the exception of the Wolf Road at River Mile 7.9 (12.7 km) SOD value, the highest SOD values recorded were in the Fullersburg Woods Impoundment above the Graue Mill Dam. Elevated SOD values were also recorded above the Oak Meadows Dam and at Butterfield Road where the width of Salt Creek expands significantly, resulting in lower stream velocities and sediment deposition during lower flow periods.

## 2.9 Continuous Dissolved Oxygen Monitoring

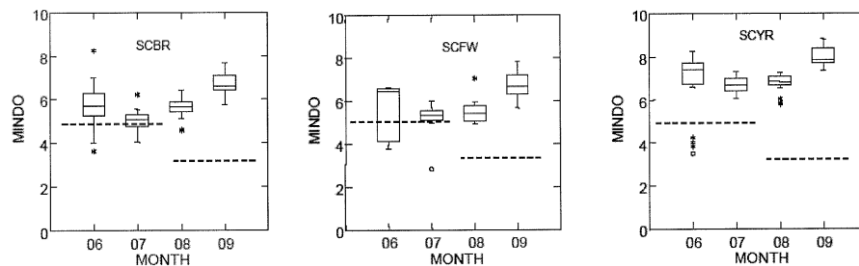
The DRSCW monitored DO at three locations along Salt Creek during the summer months from 2006 to 2008. These locations are at Butterfield Road, within Fullersburg Woods Forest Preserve 0.4 miles (0.6 km) above the dam, and at York Road immediately below the Graue Mill Dam. In addition MWRDGC maintained four 4 sondes on Salt Creek. The DO monitoring locations

were depicted on Figure 1-1. All DO data was collected according to the QAPP agreed on between the Illinois EPA and the DRSCW. Calibration of the probes for the other parameters listed was carried out according to the manufacturer's recommendations.

**Table 2-10 - DO Monitoring Locations**

Station	River mile (km)	Location	Crossroad	Steward
SCBR	16.1 (25.9)	Elmhurst	Butterfield Road	Conservation Foundation
SCFW	11.1 (17.9)	Oak Brook	Fullersburg Woods Forest Preserve	City of Elmhurst
SCYR	10.6 (17.0)	Oak Brook	York Road	City of Elmhurst

A summary of the minimum DO values for 2006 from the DRSCW probes are presented in Figure 2-11. At Butterfield Road, DO values in June and July were recorded below the 5.0 mg/L minimum DO standard, although the majority of the days achieved the minimum standard. In Fullersburg Woods, minimum DO values below 5.0 mg/L were common in June 2006 while downstream of the dam the DO levels were consistently above the minimum standard and showed less variation.



**Figure 2-11 DO values for 2006**

Figure 2-12 presents the DO results for the 2007 monitoring. The results are similar to the previous year. At Butterfield Road, DO levels in August dropped below 3.5 mg/L, the minimum DO standard for August, and in June levels below 5.0 mg/L were also reported. The minimum DO values in Fullersburg Woods in 2007 were below 5.0 mg/L for approximately 50% of the days in June, and also levels in July were below 5.0 mg/L. In August, the minimum was reported as less than 3.5 mg/L.

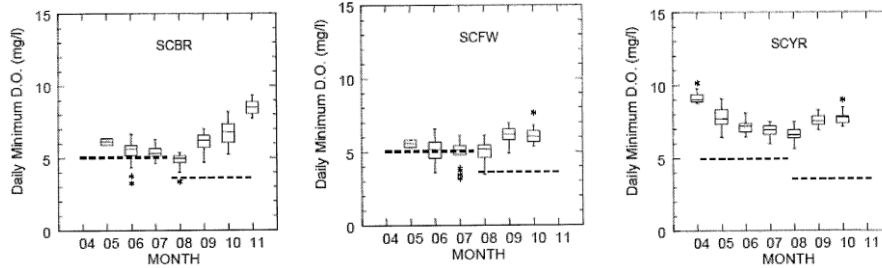


Figure 2-12 DO values for 2007

To show the diurnal variation, a sign of plant/algae activity, the time plots for the same three stations in 2008 are depicted in Figures 2-13, 2-14, and 2-15. At Butterfield Road, a DO swing on the order of 3 mg/L was typical, with minimum DO levels reaching 2.5 mg/L. The low DO results recorded in September are associated with a large rain event that likely re-suspended in-stream sediments (although wash-off of CBOD materials and CSO operation cannot be ruled out). At Fullersburg, DO levels below 4 mg/L were reported in June, and in August approached 2.0 mg/L. DO swings at Fullersburg were typically 3 mg/L in May and June and less in July. After the heavy rains in early September, the DO swings were less than 0.5 mg/L reflecting the flushing of the algae out of the impoundment. At York Road, minimum DO levels were consistently above 5.0 mg/L, and the diurnal swing was consistently less than 2.0 mg/L.

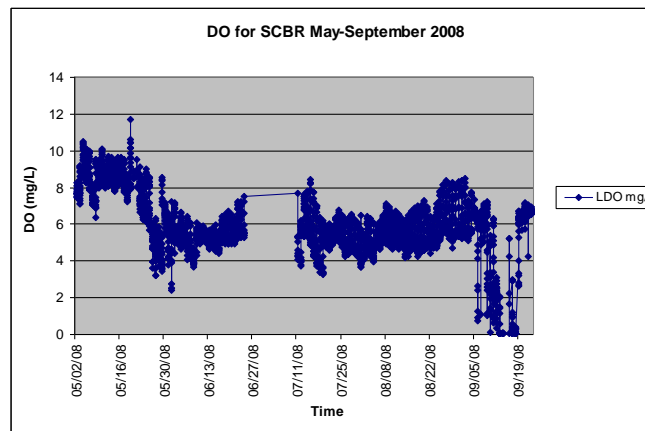
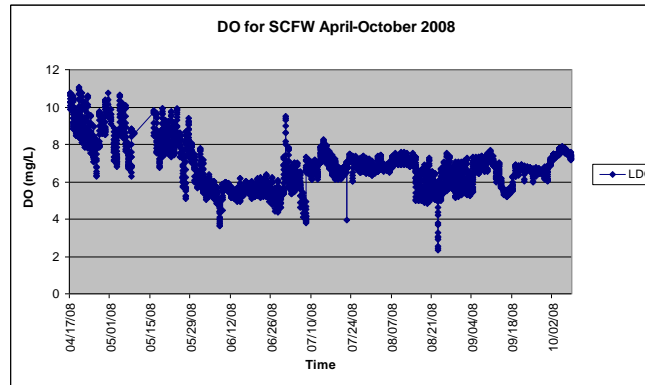
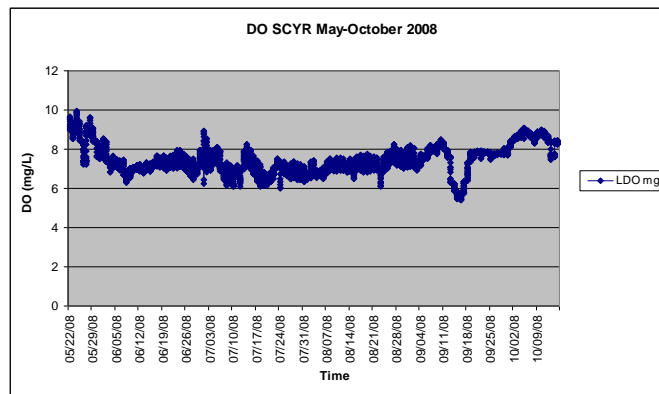


Figure 2-13 DO values for 2008 at Butterfield Rd



**Figure 2-14 DO values for 2008 at Fullersburg Woods**

Note, LDO stands for Luminescent DO, which refers to the method/equipment used for measurement.

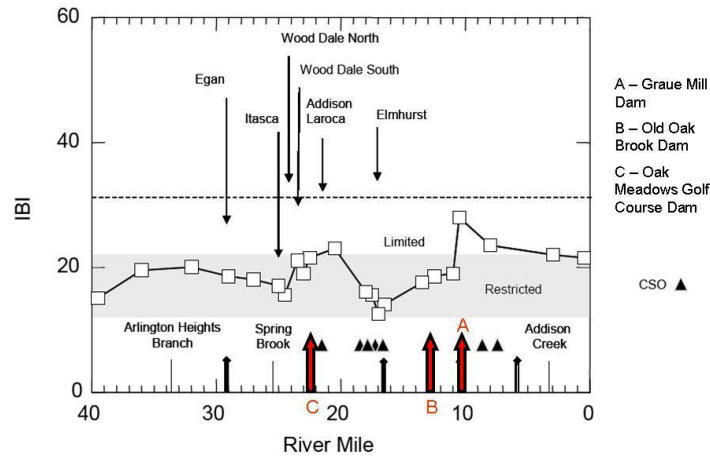


**Figure 2-15 DO values for 2008 at York Rd, below Graue Mill Dam**

## 2.10 Biological and Phosphorus Quality

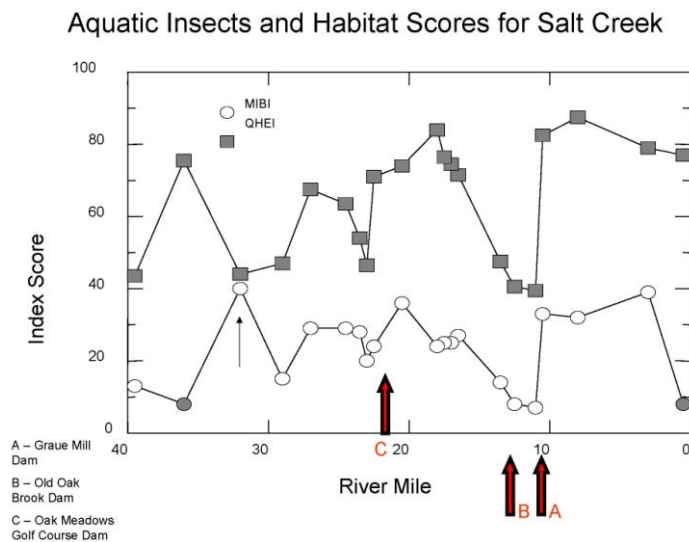
In conjunction with the DO monitoring and addressing low flow low DO issues, the DRSCW was also collecting extensive fish and macro-invertebrate data on Salt Creek (Midwest Biodiversity Institute, 2008). Figure 2-16 summarizes the Index of Biotic Integrity (IBI) for the fish collected. Moving downstream from the mouth, the biodiversity scores are higher (better) above the Fullersburg Woods Impoundment, where a sharp drop in fish biodiversity occurs. Downstream of the Graue Mill Dam, the highest (best) biodiversity scores on Salt Creek were recorded. Nineteen fish species were found below the Graue Mill Dam, while only 13 species were collected above this dam. The spike in IBI immediately below the dam is probably due to crowding as fish migrating upstream encounter the barrier (for example white suckers were found downstream of Graue Mill Dam). Wastewater treatment plant and CSO locations are also depicted in Figure 2-16. There is no consistent change in IBI scores above or below treatment plants. Biodiversity scores are the poorest near Butterfield Road, where as described previously

the creek as been over-widened resulting in very low velocities, sediment deposition, and the establishment of excessive rooted vegetation. This is also downstream of a number of CSO points.



**Figure 2-16 Fish Biodiversity**

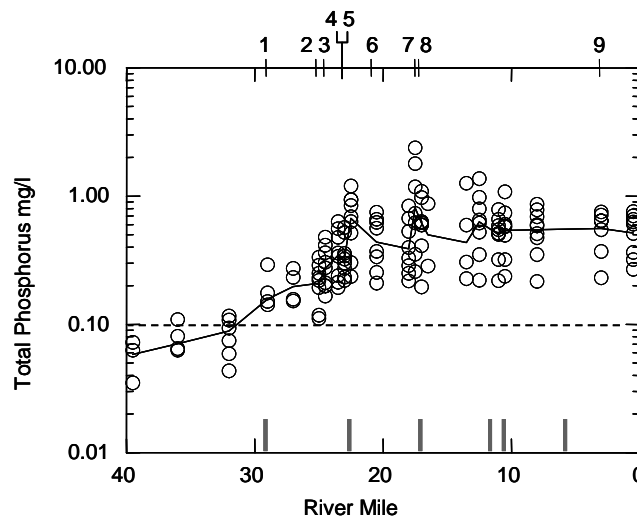
Figure 2-17 presents the macro-invertebrate quality index, as well as calculated QHEI (Qualitative Habitat Evaluation Index) scores. A similar deterioration in quality occurs with the benthic organisms as with the fish at the Graue Mill Dam; however, further upstream the benthic index improves to levels observed downstream of the Graue Mill Dam.



**Figure 2-17 Macro-Invertebrate Quality**



The Illinois Nutrient Standard Workgroup has conducted extensive research over the past five years on the correlation between nutrients, algae, and minimum DO levels. Several findings from this group’s research are that on mid-sized streams in Illinois; nutrients are never limiting sestonic, periphyton or macro-algae growth, but rather light, substrate, and stream velocities are important factors (David, M., et al., 2007). For phosphorus to be controlling, the Illinois research suggests that the total phosphorus needs to be less than 0.07 mg/L (Ibid). Figure 2-18 presents the total phosphorus measured levels along Salt Creek. In the headwaters, the levels are near the 0.07 mg/L level, and quickly increase above 0.10 mg/L by RM 32 (51.5 km). Above the first wastewater treatment plant, the total phosphorus is typically above 0.2 mg/L. The total phosphorus level in the lower 25 miles (40 km) remains steady at an average of approximately 0.7 mg/L.



- |                       |                                  |                                |
|-----------------------|----------------------------------|--------------------------------|
| 1 MWRDGC Egan WRP     | 4 Wood Dale South STP            | 7 Salt Creek Sanitary District |
| 2 Itasca STP          | 5 Addison North STP              | 8 Elmhurst WWTP                |
| 3 Wood Dale North STP | 6 Addison South-A.J. Larocca STP | 9 Addison Creek                |

**Figure 2-18 Phosphorus Levels in Salt Creek**

## 2.11 Summary

Salt Creek is a highly disturbed urban stream, with low channel gradients and extensive channelization. The wastewater treatment plants contribute a significant percentage of the total phosphorus on Salt Creek; however, above the first treatment plant, the phosphorus concentrations are already above the level that has to be attained for phosphorus to become a limiting factor for plant and algal growth. The flow contributed by the wastewater treatment plants during low flow reduces temperatures and increases stream velocities, both key factors in reducing plant and algal growth when phosphorus levels are above 0.07 mg/L.

The continuous DO monitoring has identified the DO above the Graue Mill Dam as the lowest on Salt Creek. SOD results in the Fullersburg Woods Impoundment (above the Graue Mill Dam) are elevated from the sediment that has accumulated behind the dam, a factor accentuated by the residence time and geometry of the impoundment. (Longer retention times allow for greater depletion of the DO in the water column.) The biological studies have also shown that the Graue Mill Dam is acting as a physical barrier to fish migration, and the fish biodiversity above the dam is the significantly lower than that below the dam.

From the results presented in this section, a dissolved oxygen model was developed, which is presented in the next section. The model was used to prioritize projects and develop alternatives. From this model, alternatives for improving DO levels within Salt Creek are developed in following sections.

### 3 WATER QUALITY MODELING

The *Illinois Water Quality Report 2006* identifies Salt Creek as impaired for a number of water-borne pollutants including low dissolved oxygen. Modeling analyses of Salt Creek were conducted in order to allocate allowable waste loads for BOD<sub>5</sub> and ammonia using a water quality model called QUAL2E. The original (QUAL2E) TMDL water quality model of Salt Creek was calibrated using field sampling data collected in June 1995. Since the TMDL reports in October 2004, the DuPage River Salt Creek Workgroup has improved the database from which a calibrated model could be developed.

The purpose of water quality modeling is to identify locations of low DO and then quantitatively evaluate the effects of alternatives used to improve DO. The modeling tool used in the TMDL study (QUAL2E) has been updated with a more user-friendly interface, more flexible inputs and convenient post-processing tools. The updated version of QUAL2E is called QUAL2K and was developed for the USEPA by Steve Chapra, *et al.*, at Tufts University (Chapra *et al.* 2005). Model theory, equations and parameters are described completely in the QUAL2K Users Manual. Model conversion to QUAL2K from QUAL2E and validation of the new modeling tool (QUAL2K) are described herein.

#### 3.1 Conversion of QUAL2E to QUAL2K Model

The fundamental utility of QUAL2E and QUAL2K is essentially the same; they are one-dimensional, steady-state models to predict DO and associated water quality constituents in rivers and streams. However, QUAL2K has more refined features such as the capability of diurnally varying headwater / meteorological input data and a full sediment diagenesis model to compute sediment oxygen demand (SOD) and nutrient fluxes from the bottom sediment to the water column. In addition, the QUAL2K model offers more options for decay functions of water quality constituents, reaeration rate equations, heat exchange and photo-synthetically available solar-radiation calculations.

As the fundamental theoretical underpinnings of both models are similar, the objective of this subtask was to use the input data previously used in QUAL2E and produce QUAL2K outputs that are similar to the results found in the TMDL reports. Since QUAL2E input data files were not available, the listings of input data in the appendices of the TMDL reports were used to prepare the input to QUAL2K. The QUAL2E model set-up was closely followed to reproduce those results by applying QUAL2K instead of QUAL2E. The more refined features in the QUAL2K, described above, were not implemented in order to adhere, at least initially, to the QUAL2E modeling process. Model boundaries, running from the spillway at Busse Woods Dam to the confluence of Salt Creek and the Des Plaines River remained the same. Subsequently, we independently evaluated the selection of model formulations and functions and parameter evaluations for Salt Creek as described in section 3.2.

#### 3.2 Validation of QUAL2K Model

After converting the QUAL2E model to QUAL2K, recent DO measurement data were needed to validate the QUAL2K model. Several potential sources of data include the DuPage County field

samples from the summer of 2005, the Metropolitan Water Reclamation District of Greater Chicago (MWRDGC), and newly installed DRSCW DO probes along Salt Creek.

The DO in Salt Creek was measured by DuPage County during several days starting on July 8, 2005 and ending on August 10, 2005. The field data consist of date, time, station number, cross-section position (left, middle, right) sample depth and DO. It is important to note that the measurements were performed during daylight only so that the cyclically low DO due to respiration of phytoplankton during the night time was not captured.

The MWRDGC has continuous measurements of DO and temperature at three stations along Salt Creek: JFK Boulevard (River Mile 28.7 (46.2 km), Thorndale Avenue (River Mile 26.9 (43.3 km) and Wolf Road (River Mile 8.1 (13.0 km). The first station is situated near the upstream boundary of the model and these data were used to specify headwater conditions. The second station is 3.1 miles (5 km) from the model upstream boundary such that the elapsed travel time to this point is limited and therefore only minimal change in simulated water quality would be expected. The third MWRDGC station is located more than 3.1 miles (5 km) downstream of the Graue Mill Dam, and is not within the extent where alternative aeration projects are being considered. The DO and temperature measurements at Wolf Road were reviewed to see the diurnal variation. However, these data are not graphically compared to the model results because the selection of the time when the creek was at steady-state conditions could not be made without the stream flow data.

Reach lengths were modified in QUAL2K based on up to date GIS data developed as part of this project as opposed to USGS River Mile information used in QUAL2E. River mile /km differences for Salt Creek were as high as 2.4 miles (3.8 km) in the upstream reaches (near River Mile 25 (40.2 km) and gradually decreased with distance downstream between the GIS and USGS data.

The DO data were plotted against river distance to show the range in DO and provide an approximate basis for comparing QUAL2K results. As QUAL2K is a steady-state model, it assumes that stream conditions, such as flow, point source discharge and loadings, are constant in time. Sampling to collect data for comparison to a steady-state model is normally performed during periods when flow and other conditions are relatively constant. However, the initial DO data may not reflect steady-state conditions because of the variability in flow, meteorology, point source loadings and headwater conditions during the 32 day sampling period.

Water quality data were collected in 2006 and 2007 to improve the calibration of the QUAL2K model of Salt Creek. DO and temperature were measured continuously at seven sampling stations, as described in Section 2. Sediment Oxygen Demand (SOD) was measured in situ at eight stations in the summer of 2006 and another eight stations in the summer of 2007 to provide data for estimating the SOD model parameter in Salt Creek.

### **3.2.1 Model Inputs**

This section describes the model inputs developed to simulate the period of DO data collection, as well as changes to the hydraulic characteristics (i.e., stream slope, depth and width data)

necessary to reflect findings obtained during the field data collections (see Section 2.0, Existing Conditions for more details) and additional data collected. Reaction rate coefficients that depend on stream depth and velocity, such as the reaeration rate coefficient and the BOD oxidation coefficient, were also changed to reflect the changes in the hydraulic data. Other model parameter values from QUAL2E were also changed in QUAL2K in an attempt to improve its ability to simulate conditions in Salt Creek as explained below.

USGS flow data for the summers of 2006 and 2007 were presented graphically to identify periods of low flow that would be suitable for model calibration and verification. Precipitation data were also plotted to show that dry weather conditions occurred during the identified low flow periods and there were no significant wet-weather sources (storm water, combined sewer overflows) at these times. The model was calibrated using data for the low flow period of August 1-4, 2007 and verified for the low flow period of June 19-21, 2006. Model projections of baseline conditions and management alternatives were based on these conditions, when most of the flow comes from point source discharges. Input data for flow and point sources are specific for the selected time periods or the model projections. Input data for other model parameters are the same for both time periods and the model projections, unless noted otherwise. Reaction rates (decay, re-aeration) are input at a single temperature and adjusted internally by QUAL2K to the temperature calculated by the model. SOD for each reach is based on the temperature and the measured SOD rate in that reach.

- **Headwaters and Tributaries:** Headwater flows were taken from USGS flow data for the selected periods. Flows from point sources were accounted for in calculating flows with distance upstream of the gaging stations. Tributary flow was also estimated based on the ratio of flow to drainage area at the gaging station and the estimated drainage area of the tributary. The hourly DO at the headwater of Salt Creek was based on the Busse Lake Dam station continuous DO measurements from MWRDGC. This station is located near the headwater of the main reach of the Salt Creek, and therefore is representative of the boundary conditions of the model. The same diurnal variations of DO and water temperature were also implemented for the tributaries. The DO, CBOD<sub>5</sub>, and ammonia concentrations of the tributaries were assumed to be the same as the QUAL2E model.
- **River Distances:** As mentioned earlier, stream reach lengths were modified in QUAL2K based on GIS data developed for this project whereas USGS information was previously used in the QUAL2E model.
- **Model geometry:** Main channel slopes were revised using the Digital Elevation Model (DEM) developed by USGS for Salt Creek. The DEM is publicly available in a GIS format and elevation information for end points of each reach segment was extracted from the overlay of the DEM and reach end points set up in QUAL2K. In addition, impoundment areas, where there are occurrences of hydraulic backup and sedimentation due to the presence of dams, were delineated as a refinement in QUAL2K. This was done by subdividing the appropriate QUAL2E model reach into two reaches for QUAL2K, a free-flowing reach and an impounded reach. Water depth information was taken from the Existing Conditions Report (see Section 2.0). A

sediment survey of the Fullersburg Woods Dam Impoundment, supplied by the Forest Preserve District of DuPage County (1997) was used to set the geometry of the reaches in this part of the model. These changes of channel slope, depth and velocity in impounded areas would potentially change reaeration rates and BOD deoxygenation rates as explained under “decay rates” below.

- **Meteorological Data:** Air, dew point temperatures were changed to represent more reasonable local effect of weather for a period with which model validation was compared. Other meteorological inputs such as wind speed, cloud cover and shades were set to 0 m/s, 30% and 0%, respectively. As the primary intent of the model is to simulate hot, low flow conditions, precipitation data are not included as input.
- **Decay Rates:** As stated, changes to the stream geometry indicated that reaction rate coefficients would also change. CBOD, nitrification and settling rates of various water quality constituents were changed using stream characteristics and a more reasonable range based on Chapra 1997, Thomann and Mueller 1987 and EPA 1985. Velocity and depth are generally calculated by QUAL2K except for impounded reaches, where these data are taken from the Existing Conditions section and directly input to the model. Appendix C includes the inputs for the decay rates and reaeration rates in Salt Creek.
- **Background Light Extinction:** In an effort to account for the fact that the model lacks absorption and back scatter of light by particulates (total suspended solids (TSS) was not simulated in the model), a higher background light extinction rate was used compared to QUAL2E inputs. Appendix C includes the light and heat inputs.
- **Point Sources:** There are seven municipal wastewater treatment plants that discharge into Salt Creek. These are depicted on the graphs developed by letter code, as summarized below:

<u>Point Source</u>	<u>Label</u>	<u>River Mile (km) from Mouth</u>
Egan	a	29.6 (47.6)
Wood Dale N	b	25.7 (41.4)
Wood Dale S	c	25.3 (40.7)
Addison N	d	22.6 (36.4)
Addison S	e	20.9 (33.6)
Salt Creek SD	f	17.9 (28.8)
Elmhurst	g	17.8 (28.6)

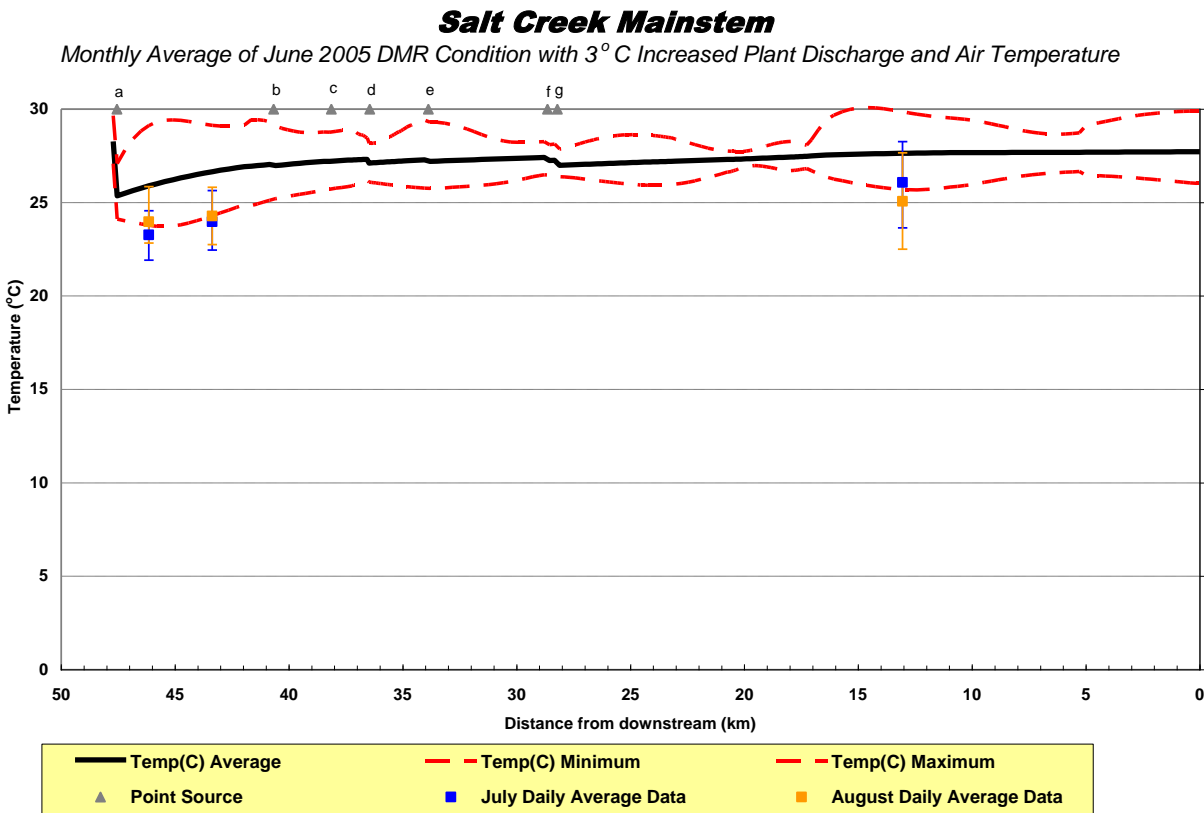
Monthly Discharge Monitoring Reports (DMR) monthly average pollutant loadings for August 2007 and June 2006 were utilized as representative of low flow, warm, summer effluent quality. The monthly average values were used to set discharge flows, CBOD<sub>5</sub> and ammonia concentrations.<sup>1</sup> Other effluent data, such as organic

<sup>1</sup> Actual performance data over a month period is more representative of true worst case conditions, as opposed to assuming all treatment plants are discharging at their daily permitted maximum limits under dry, warm conditions.

nitrogen, nitrate, phosphorus and DO concentrations, were not available in the DMR data; therefore, the previous QUAL2E inputs were used.

- Temperature:** Temperature is calculated by QUAL2K and compared to the measurement data for the calibration and verification model runs. Model projections were based on setting air temperature so that the stream reached temperatures approximately 3°C warmer than average temperatures observed in July and August 2005.

Based on historical temperature data, the stream temperature reaches temperatures approximately 3°C warmer than was observed in June/July 2005. Figure 3-1 depicts the stream temperature that would be used for the baseline conditions, reflecting the *worst case* conditions.



**Figure 3-1. Baseline Stream Temperature for Salt Creek**

- Flow:** Figure 3-2 depicts the base flow predicted in Salt Creek based on the actual discharges from the wastewater treatment plants in June 2005 and the base flow. Model projections are based on the flow in this Figure. The resulting travel times under low flow conditions is presented in Figure 3-3. The overall travel time from the

- most upstream wastewater treatment plant (Egan) to the mouth is on the order of 5 days under low flow conditions.

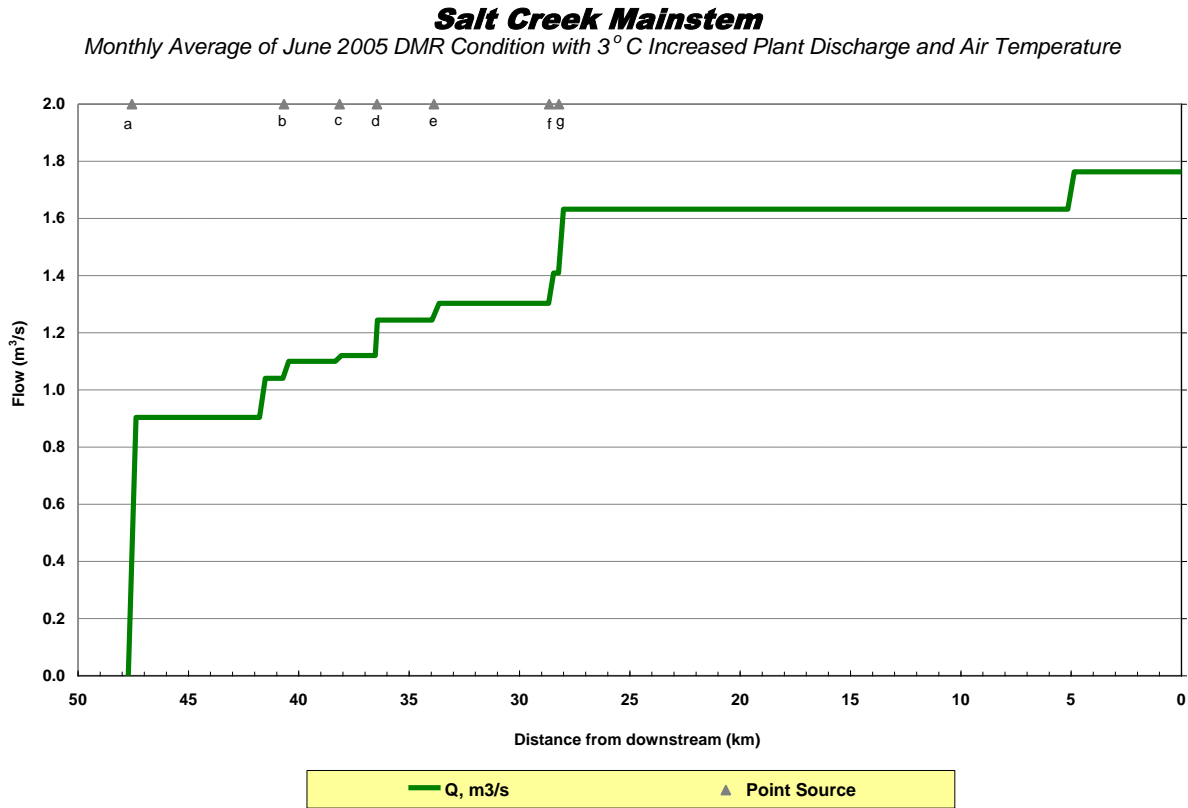


Figure 3-2. Base Flow for Salt Creek



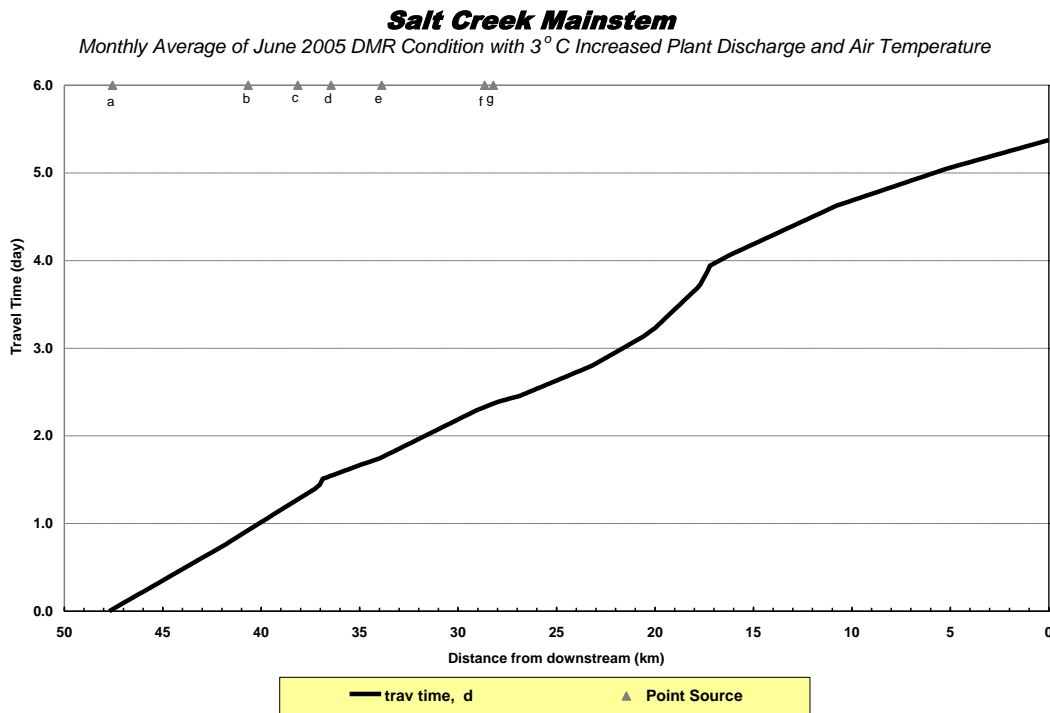


Figure 3-3. Travel Time in Salt Creek, June 2005

- **Sediment Oxygen Demand:** The SOD rates in the TMDL QUAL2E model input listings estimated at 0.2 to 1.5 g/m<sup>2</sup>/d for Salt Creek were lower than expected for the existing conditions. SOD measurements were conducted on Salt Creek in 2006 and 2007 to improve input into the QUAL2K model. The Salt Creek SOD Reports for 2006 and 2007 are included in Appendix B. The SOD measured at ambient temperature in Salt Creek ranged from a minimum of 0.28 g/m<sup>2</sup>/day to a maximum of 3.60 g/m<sup>2</sup>/day. The highest SOD was observed in the impoundment upstream of Graue Mill Dam, and at a single site below the Graue Mill Dam, which does not appear representative of this stretch. Figure 3-4 presents comparisons of the SOD results during the 2006 and 2007 surveys, adjusted to a water temperature of 20°C. The 2007 SOD rates are similar to the 2006 SOD rates in the impoundments of the Old Oak Brook and Graue Mill Dams.

Using the base temperature (see above), the measured SOD rates were adjusted. Figure 3-5 presents the SOD rates with the 3°C increase in June temperatures for each segment of the creek.

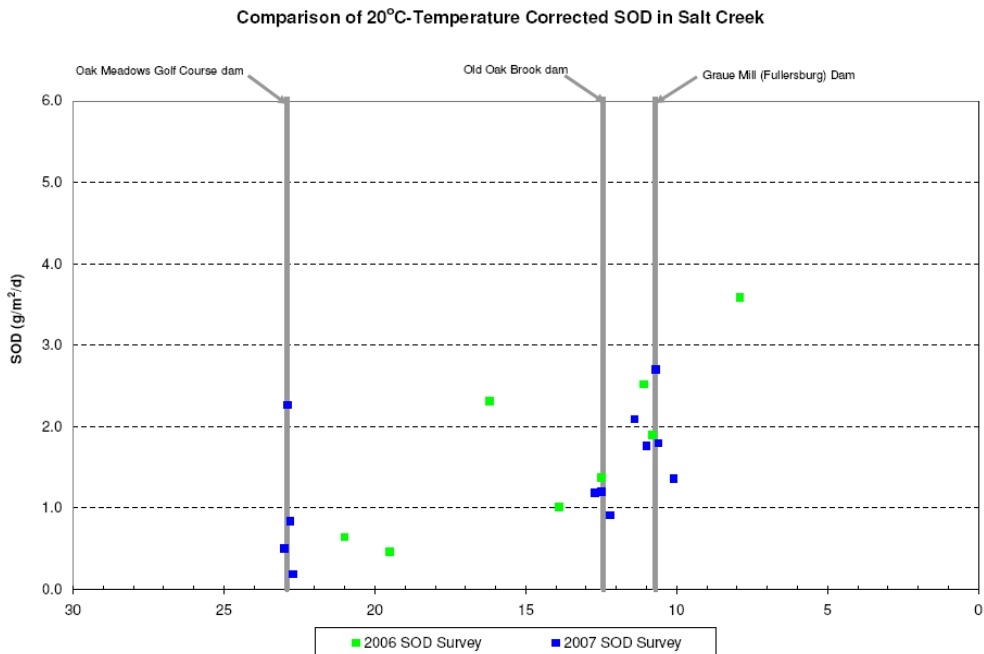


Figure 3-4. Comparison Temperature Corrected SOD in Salt Creek

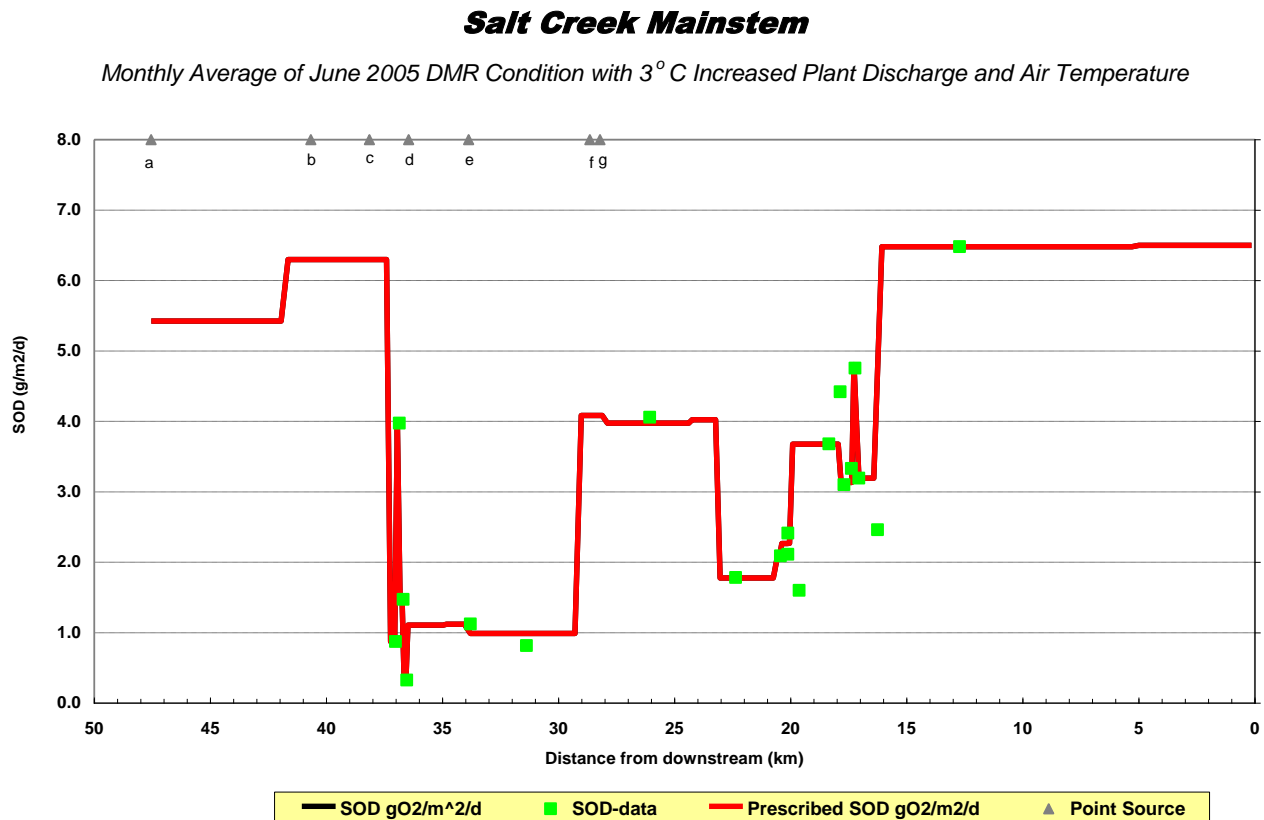


Figure 3-5. SOD rates with the 3°C increase in June temperatures

### 3.2.2 Calibration and Verification of the Model

Under low stream flow conditions, the contribution from the point source discharges to Salt Creek collectively account for 46% of the total flow at the model’s downstream boundary. To calibrate the model data from August 1-4, 2007 were utilized and the graph is labeled August 2, 2007. The model inputs are included in Appendix C, and the predicted DO versus measured DO at specific locations is depicted in Figure 3-6. Stream temperatures ranged from 23 to 31°C on this date, and the stream flow was essentially at low flow conditions. The model, as presented in Figure 3-6, predicted higher minimum DO values above Oak Meadows Dam and below the Graue Mill Dam, generally by less than 1 mg/L. However, overall, the model reasonably predicts the average DO and the diurnal variation in DO.

To verify the model will accurately predict DO changes under varying conditions, the model was run for the conditions on June 19-21, 2006 and the graph is labeled June 20, 2006. Input data are presented in Appendix C, and the model prediction is presented in Figure 3-7, along with actual DO measurements. A larger diurnal swing in DO was present above the Old Oak Brook Dam than predicted. This is attributed to an increase in algal and aquatic plant population. Measured DO minimum levels were also lower than the model predicted; however, the results were within

0.5 mg/L. Model results overall showed excellent agreement with observed conditions in the calibration model and the validation models.

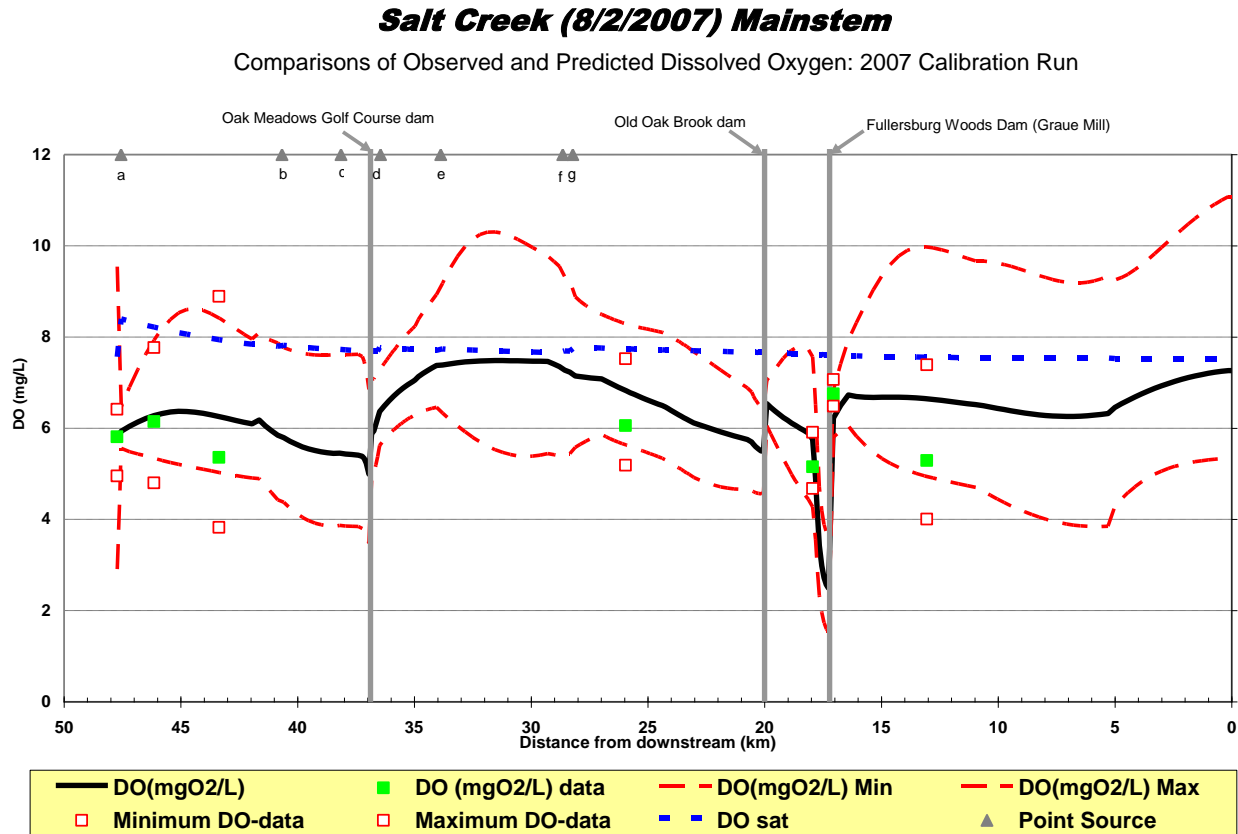


Figure 3-6. Predicted vs. Measured Dissolved Oxygen for August 2007 for Salt Creek

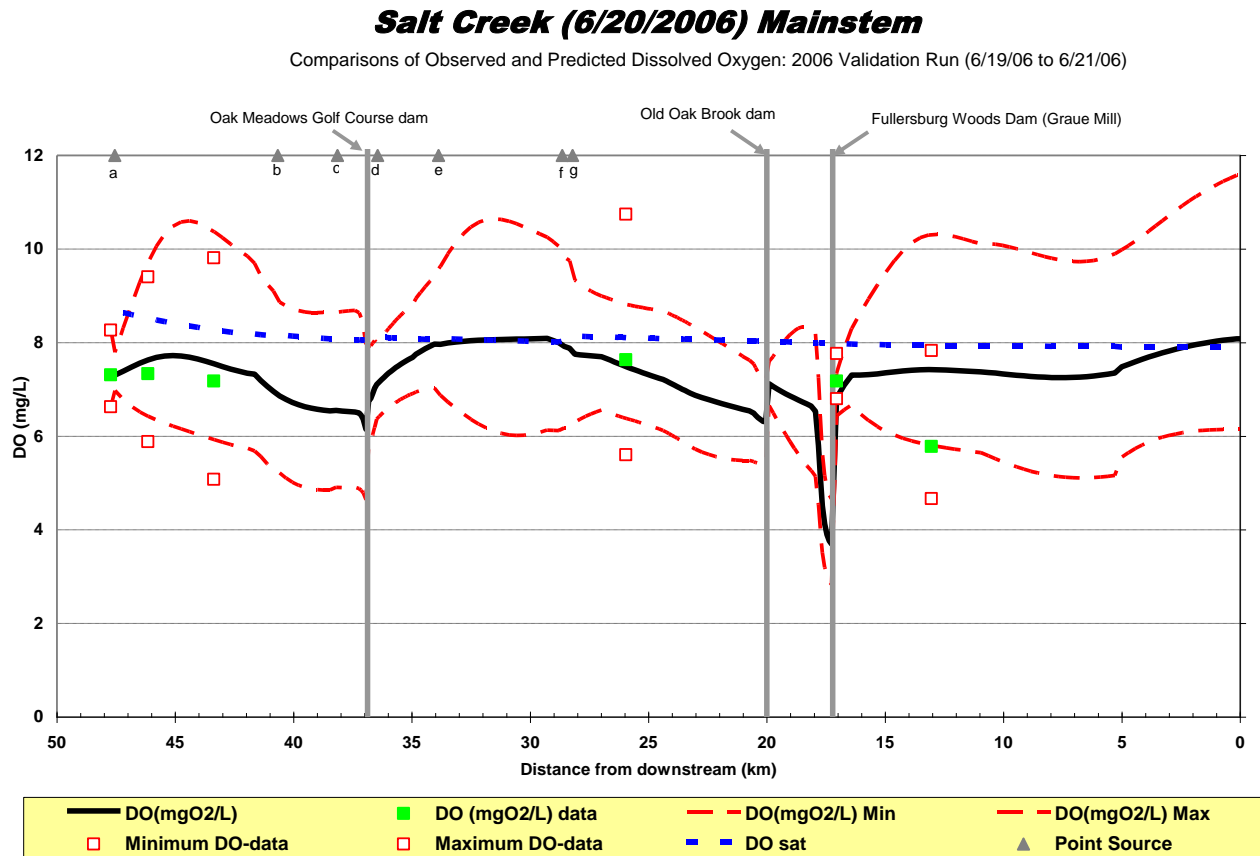


Figure 3-7. Predicted vs. Measured Dissolved Oxygen for July 2006 for Salt Creek

### 3.2.3 Sensitivity Analysis

Sensitivity runs were completed for changes in both SOD and re-aeration constants. These results are presented in Appendix C. Both of these variables have a significant impact on the predicted DO values; however, such changes do not improve the overall predictions compared to the actual results.

### 3.2.4 Baseline Model

The value of a model is to predict worst case conditions and the impacts of improvement alternatives on those conditions. In modeling the worst case scenario, temperature is a prime factor, as the temperature increases, the saturation (solubility of oxygen) of DO in water decreases and respiration increases (both in the water column and in the sediment). Recall, from a review of historical temperature data, the stream can reach temperatures approximately 3°C above the levels recorded in July and August 2006. This temperature and low flow, with the average summer CBOD and ammonia discharged from the seven wastewater treatment plants was used as the baseline *worst case* scenario. Figure 3-8 presents this baseline model. From this model, alternatives for improving DO levels can be evaluated, and this is done in Section 6. The Baseline Model predicts minimum DO levels just above the Oak Meadows Dam reaching 3.5

mg/L. At the Old Oak Brook Dam, the minimum DO predicted is at 4.1 mg/L, and just above the Graue Mill Dam, minimum DO levels are predicted to reach 1.2 mg/L. The model, consistent with the monitoring results, predicts under these extreme conditions that the pool areas created by the dams are the areas with the lowest DO levels. The Old Oak Brook Dam's impact on the upstream DO levels is less pronounced than in the pools above the other two dams.

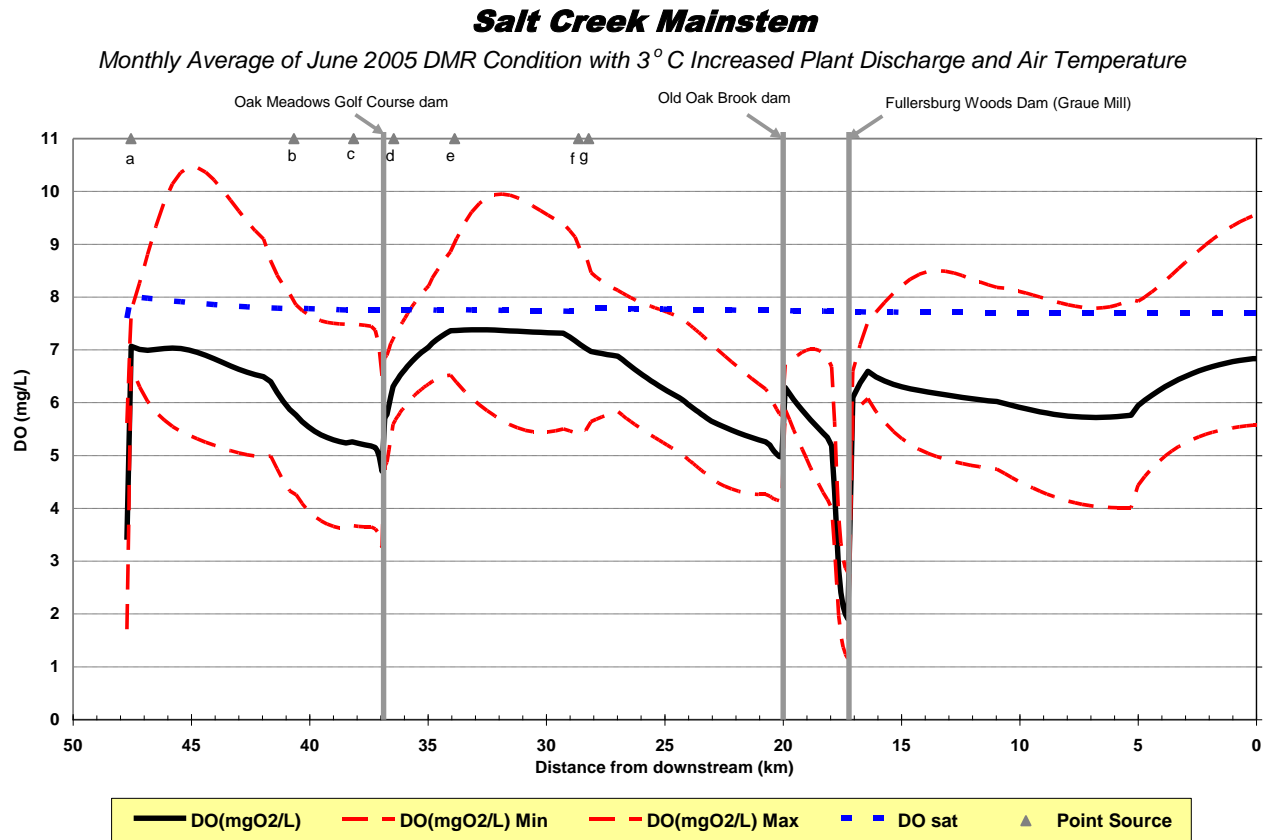


Figure 3-8. Baseline Dissolved Oxygen for Salt Creek

## 4 SCREENING FOR DAMS

Small, low-head dams impose a number of negative impacts on rivers through both their nature and their number. Dams inhibit the natural linear flow of energy in the stream system, be it in the form of flowing water, sediment transport, fish migration, macroinvertebrate drift, or downstream nutrient spiraling. Specific to the impact on dissolved oxygen, dams create impoundments that concentrate sediment and organic material upstream which actively respire, removing dissolved oxygen from the water. In addition, dams slow the velocity of the water, allowing additional time for sediment decomposition to remove oxygen from the water column and for solar energy to increase water temperature (water temperature is inversely correlated to water's capacity to hold dissolved oxygen). These effects are further exacerbated as dams increase the width of the stream, increasing the water column/sediment interface and limiting the extent that riparian shade can counter the effect of solar heating. As water temperatures increase, the re-aeration rate from the atmosphere decreases because the DO saturation value decreases with increasing temperatures.

Complete removal or retrofitting of dams is an increasingly utilized tool to eliminate the disruptive influence that dams create within the fluvial system. The impacts of dams on sediment continuity, flood conveyance, and aquatic flora and fauna have been well documented in the literature. However, there is little guidance that exists for handling a dam removal or retrofit. Questions about the fate of impoundment sediment, mechanisms for dewatering, and short versus long term impacts to the health of the stream dominate any dam removal or modification project, and must be addressed prior to the actual project.

The three options being investigated in this study are: complete removal; partial breach, and partial removal with bridging. These options are being driven by the primary design objective of improving the DO content of the stream. A secondary design objective is to re-establish biological connectivity, mainly in the form of faunal passage.

### 4.1 Complete Removal

Complete dam removal involves the removal of the entire dam structure. The most common case for removal is to eliminate the legal definition of a dam at a particular site, thereby removing liability and responsibility from the owner. Usually dams have exceeded their design life, and the cost of rehabilitation is greater than the cost of removal. Ecological benefits can be significant.

Complete removal can occur in a number of ways based on site conditions and budget. Dams with a substantial amount of sediment behind the structure are typically drawn down in stages to minimize the downstream transport of sediment. Sediment in the dewatered impoundment can be excavated and/or stabilized in place, depending on the type and quality of material (i.e., silt versus sand and contaminated versus non-contaminated).

Depending on the size of the impoundment, varying levels of restoration of the new channel are required. In large impoundments, the effort for restoration is great, while in narrow impoundments, the restoration effort may be less extensive.

There is a broad range of effort that can be dedicated to restoration of the site based on funding, aesthetics, resource use, aquatic and terrestrial wildlife needs, hydrology, and sediment transport.

A passive approach (minimal effort) to channel rehabilitation might include the excavation of a fairly straight, perhaps oversized channel through the impoundment. This would allow the stream to do most of the work of recovery, creating its own path and allowing flood and groundwater hydrology to dictate the riparian vegetation regime over a prolonged timescale. Time scales for the completion of this restoration can range from decades to centuries depending on site conditions. Alternatively, active channel restoration, requiring the largest effort, would involve the complete construction of a functioning floodplain and sinuous channel similar to what existed prior to dam construction. The geometry of this channel would emulate the historical channel but would be designed to function appropriately within the constraints of modern hydrology and sediment loading. This active restoration option could be constructed within a few months but for a greater cost. The costs and time scales for these approaches are drastically different to achieve the same ultimate outcome, the re-establishment of an intact fluvial system.

## **4.2 Partial Breach or Notching**

Breaching includes everything from a simple v-notch weir to removal of a section of a dam (partial breach). Depending upon the design, sediment transport and fish passage can usually be achieved. However, if the velocity through the breach is too great, fish passage may not occur, and safety issues to paddlers could also result.

## **4.3 Bridging**

The third option is bridging. The basic concept is to build a ramp of large rock leading up to the downstream face of the dam. The ramp effectively “bridges” the dam by providing upstream-downstream fish passage and possibly canoe passage. Common variations to this include partially removing or lowering the dam crest in order to decrease the vertical elevation that must be made up downstream and to reduce the impoundment on the upstream side of the dam. In addition, notching the dam crest (alternative 2) to concentrate flow in the center of the channel is also commonly employed with bridging.

Bridging provides fish passage and aeration as well as some interstitial habitat for macro-invertebrates. It also preserves a fixed water surface elevation upstream. Bridging, resulting in a lower pool elevation, will reduce retention time, impoundment water temperatures, and sediment deposition. Bridging does not remove the legal designation of a dam at the site. The State of Illinois’ definition of a dam is “any structure built to impound or divert water.” Thus the responsibility for maintaining and monitoring the structure will remain with the dam owner. There is a possibility for the hazard classification of the structure to be downgraded if partial removal diminishes the hydraulic impact of the structure.



## 4.4 Issues Common to All Dams

There are several issues that need to be addressed for projects with modifications to existing dams. Permitting by federal, state, and local agencies, characterization and disposal of sediments removed from dam impoundments, and impacts of dam removal on flooding must be considered.

### 4.4.1 Permitting

In Illinois, the resource agencies generally recognize the ecological benefits of dam removal/bridging projects. However, the historical characteristics of a dam must be weighed against any modifications to a structure. Storm water and wetland impacts are two other central issues around any project that will modify/remove a dam. There are three levels of permitting that will be required for each project, with variations on each depending on the design method chosen. The Joint Permit Application Packet is designed to simplify the approval process for the applicant seeking project authorizations from the U.S. Army Corps of Engineers, the Illinois Department of Natural Resources Office of Water Resources, and the Illinois Environmental Protection Agency.

**Federal Level** – At the federal level, the Army Corps of Engineers has jurisdiction over any design that will impact wetlands or waterways. Because DuPage County’s regulations are more stringent than the Federal Laws, a memorandum of understanding has been in place that allows much of the permit review for the Federal 401/404 permit to be accomplished by the County. An Environmental Assessment will be required for any dam modification/removal project if federal funds are utilized. A Regional 404 permit would be applied for dam removal or modification.

**State Level** – Permitting from the State of Illinois involves primarily the Illinois Department of Natural Resources (IDNR) and the Illinois Historic Preservation Agency. Within the Joint Permit Application process, there are several layers of review that require the approval of various agencies. The IDNR Office of Water Resources has established requirements for applications for permits to remove dams, detailed in Section 3702 of the State Administrative Code. The Office of Water Resources handles aspects mainly related to the construction (removal) process, such as the plan for dewatering and upstream restoration and the impacts to the flood profile. The IDNR Office of Realty and Environmental Planning will perform a review of the project to ensure no impacts to threatened or endangered species.

A review will be done by the Illinois Historic Preservation Agency to ensure no potential impacts exist to state historic or archaeological resources. This Agency has consistently determined that dams have historical significance. This would certainly be true for the Graue Mill Dam; therefore, any modifications will be closely reviewed by this Agency and the conflict between the ecological benefits and changes to a historical structure will have to be weighed.

If federal funds are used to remove Graue Mill Dam, a Section 106 analysis may be needed. Additional regulations that may apply depending on the project include Part 3708 – Floodway Construction in Northeastern Illinois.

The Illinois EPA provides water quality certifications (401) for Individual 404 permits; however, this project analysis is not necessary for Regional Permits. Previous dam removal projects have only required a Regional Permit.

**County Level** - DuPage County permitting requirements are more stringent than most State or Federal requirements. As a result, once the county requirements are met for various items held in common among both state and federal regulations, the federal and state requirements are also met by default. It is important to note that this is only for certain items, such as wetland impacts, that are common among the three levels of permitting. Other items, such as dam safety and the regulations associated therein, are not common among the various permitting agencies and so the responsibility remains with the issuing agency, in this case, IDNR.

The county has a single permit application that covers all work in waterways that will be proposed on this project. The storm water permit includes provisions for hydraulic/floodplain impacts, wetland impacts, and property impacts.

Hydraulic/floodplain impacts are the most important category to identify prior to taking any project beyond conceptual design. It is premature to estimate what the impacts of the three alternatives would be at each of the dam locations. Removal of fixed elevation dams may increase or decrease the flood elevation depending on location along the profile, the nature of the impoundment, and the local hydraulics at the site for a range of flood events. Regardless of the alternative used at the site, it will likely require a Letter of Map Revision (LOMR) through the Federal Emergency Management Agency (FEMA). The LOMR is needed for both increases and decreases to the existing base flood elevations. If an increase in the base flood elevation is needed, easements will have to be secured from adjacent property owners who are affected.

Wetland impacts will be an important parameter to characterize in the project. Wetland impacts associated with dam removal are evaluated on a case by case basis. Wetlands that have been created as a result of dam construction may be impacted by dam modifications or removal, and mitigation may be required depending on the acres involved and quality of the wetlands.

#### **4.4.2 Reservoir Sediment**

The correct characterization and understanding of reservoir sediments is the largest factor governing dam removal. All three options have the potential to mobilize impoundment sediment to varying degrees. Full removal and the partial breach option would provide similar amounts of material available for transport, whereas as bridging would have a more limited impact on reservoir sediments. Reservoir sediments must first be evaluated for contamination. If material is deemed to be contaminated, the options for removal are likely limited to those that involve full removal of all contaminated material after drawdown or suction dredging material prior to dewatering the reservoir. This situation represents the most costly project scenario. If it is determined that the sediment is not contaminated, the next concern is minimizing the amount of material that may move downstream.

There are few models currently available to accurately predict the movement and transport of reservoir material following a dam removal. The DREAM model developed by UC-Berkeley and Stillwater Sciences has made some inroads to model transport following dam removal;

however, it has been developed for non-cohesive silt, sand, and gravel situations, which do not often exist in Midwestern impoundments, full of clays and silts. HEC-6 has been used in the past to model transport, but it is incapable of accurately modeling the steep slope that results once the dam is removed and the knickpoint begins to move upstream (Cui, et al., 2006a, b).

Until actual sediment data are available, assumptions on the sediment handling options are necessary. In the early 1990s, the sediment above the Graue Mill Dam was removed and was not deemed contaminated at that point in time, so it is reasonable to assume that would still be the case today. A requirement of minimizing sediment from being carried downstream means the sediment must be removed mechanically, at least in the natural channel.

#### **4.4.3 Flood Impact**

A full understanding of flood impacts related to dam modification can only be fully understood with careful modeling. The dams on Salt Creek are all low head and operated as fixed elevation dams, meaning there is little available storage in the impoundment to mitigate downstream flood impacts. In most situations given dams of the size and nature as those on Salt Creek, breaching or removal will usually lower flood profiles for minor storm events upstream with little if any change below the dam. Regulatory flood events, in most cases the 100-year flood, often have no change to the water surface profile, as the hydraulic impact of such small structures are lost during such a major flood event. A full analysis of the hydraulic performance of various dam modifications will be performed in accordance with stated DuPage County ordinances and requirements.

## 5 SCREENING FOR STREAM AERATION

Numerous aeration technologies have been developed and utilized to increase dissolved oxygen (DO) in water. Oxygen transfer efficiency (OTE) is the amount of oxygen that is absorbed by (dissolved into) water during the aeration process divided by the amount of air or oxygen applied to the water. The difference between the saturated DO concentration and the DO of the water column is termed the “DO deficit”; OTE is directly proportional to the DO deficit.

The higher the water temperature is the lower the DO saturation value. The lower the DO saturation value, the lower the DO deficit ( $DO_{\text{saturation}} - DO_{\text{stream}}$ ), and the less efficient oxygen transfer becomes with air. Where the model predicts a minimum DO of 5.0 mg/L, aeration is required. At 25 degrees C, the DO saturation is only 8.2 mg/L, so the DO deficit is 8.2-5.0 mg/L or 3.2 mg/L. If the aeration were installed where the river reaches 3.5.0 mg/L, the DO deficit would be 4.7 mg/L, or 47 percent higher OTE than where the initial DO is 5.0 mg/L. If the goal is to maintain a minimum DO of 5.0 mg/L, then the aeration system must be installed where the stream DO first drops below 5.0 mg/L. This limitation is a drawback to air-based systems.

Available technologies can be divided into three categories: Air-Based Alternatives, High-Purity Oxygen Alternatives, and Side-Stream Alternatives. Subsections 5.1, 5.2 and 5.3 briefly describe various technologies and subsection 5.4 provides an overview of the screening process.

### 5.1 Air-Based Alternatives

The following air-based alternatives are grouped into Simple Aeration, Mechanical Aeration, and Bubble Aeration.

#### 5.1.1 Simple Aeration

Often associated with stream elevation changes, simple aeration exposes water to the atmosphere as it drops and/or splashes into a lower pool. As a result, oxygen is entrained and the DO concentration is increased as the water loses elevation. Examples of simple aeration devices include weirs, inclined corrugated sheets, splashboards, cascade aerators, multiple-tray aerators, towers, and columns. The existing dams in Salt Creek also show simple aeration as water travels over the spillways and into the plunge pool, replacing some of the DO consumed in the impoundment.

If suitable elevation changes are not present to create aeration, which is the case on Salt Creek, elevation can be created using pumping to transfer water to an aeration device. In general, implementation of this technology will require; land along the shoreline for installation, a power source for pumping, permitting, and maintenance access. The advantages to simple aeration alternatives include relatively low operation costs, ease of construction (in some cases), and limited moving parts to service. The main disadvantages include higher maintenance costs to remove debris collection or clogging and a limitation on how much oxygen can be physically transferred, generally meaning that multiple installations are required. Oxygen transfer efficiencies for these alternatives are low-to-moderate. Specific efficiencies are dependent on

the height of the elevation drop or the height of the aeration device, water velocity, and the initial DO concentration.

### **5.1.2 Mechanical Aeration**

Mechanical aeration is achieved with devices that create movement in the water, via splashing or agitation, convection, or circulation between the top and bottom of the water column. Most mechanical aerators are designed to operate at or near the surface of the water column and draw water up into the air, but some aerators may be submerged and function by drawing the oxygenated surface water to the bottom of the water column. Common examples of mechanical aeration include paddlewheels, spray aerators, propeller-aspirator aerators, and jet aerators. Implementation of these devices may require site considerations for constructability, availability of an electrical source, permitting due to navigational impacts, placement of equipment and access for maintenance and operation. All mechanical aerators require electrical power and continuous maintenance on working parts.

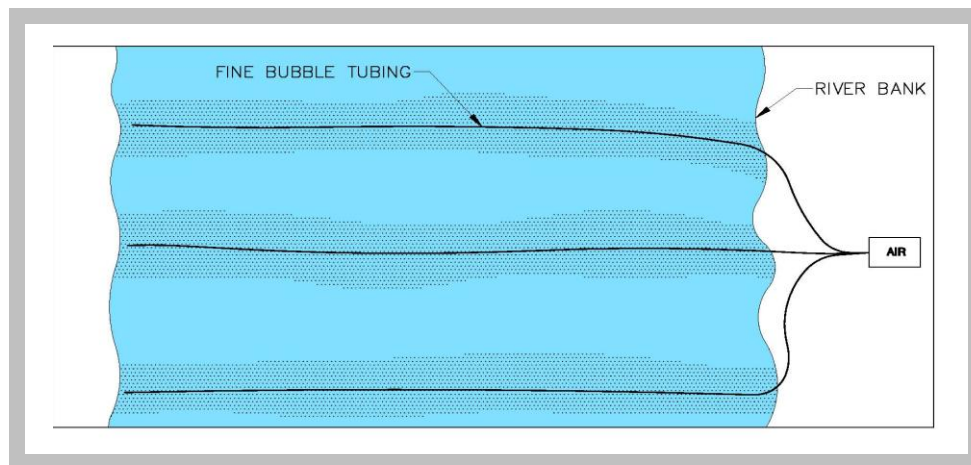
Advantageous features of mechanical aeration devices include the ability to be placed within pooled areas thereby minimizing land impact, the ability to be placed along the flow path to maintain a desired DO, and generally lower cost for implementation. Disadvantages of mechanical aeration include the need for a continuous power source to each unit, operational costs for power consumption, generation of noise during operation, possible safety issues, potential for navigational impacts, maintenance for debris removal, sediment disturbance, and susceptibility to damage during flood-stage conditions. In general, oxygen transfer efficiencies for these devices are low-to-moderate when trying to maintain DO levels above 5.0 mg/L.



**Figure 5-1 - Mechanical Aeration Display**

### 5.1.3 Bubble Aeration

Bubble aeration consists of utilizing blowers or air compressors on the shoreline to introduce bubbles into the water column through air diffusers. The generated air stream is delivered via piping or tubing to air diffusers at the bottom of the water column. In general, air is forced through the diffuser resulting in a release of small bubbles into the water. In order to install bubble aerators, site considerations may be required for constructability, the thickness of the bottom sediment, availability of an electrical source, equipment, and periodic access for maintenance and operation.



**Figure 5-2 - Bubble Aeration**

Advantages of bubble aeration include the ability to be placed in existing conditions with relative ease, minimal impacts from floating debris and flood-stage conditions, widely serviceable components for repairs, and the ability to operate in series. Disadvantages of bubble aeration include the need for a continuous power supply and the potential that sediment transported during heavy rain events will bury the tubing. . Oxygen transfer efficiencies are a function of water depth, from poor at shallow depths (less than 3 ft) to moderate at depths ranging from 5 to 6 ft (1.5-1.8 m).

## 5.2 High Purity Oxygen Alternatives

High-purity oxygen alternatives for increasing dissolved oxygen are based on contacting the water column with a concentrated source of oxygen, with or without pressure above ambient atmospheric conditions. This concentrated or high-purity oxygen source is generally 90 to 99 percent oxygen versus the atmospheric percentage of around 21 percent. High-purity oxygen applications generally utilize on-site storage of oxygen in liquid form. Specialized liquid oxygen vessels store the oxygen under pressure and utilize on-site vaporization to convert liquid oxygen to gaseous oxygen. Site piping is also required to distribute the gaseous oxygen to the various contact methods. As an alternative to liquid storage, on-site oxygen generators can be utilized to

provide a source of high purity oxygen; however, given the seasonality in the need for the oxygen, on-site generation is not cost competitive with on-site storage.

High-purity oxygen systems differ from atmospheric systems due to the nearly five-fold increase in oxygen concentration in the gas and the higher gas pressure that can be utilized. In high-purity oxygen systems with increased back-pressure in the mixing chamber and higher oxygen concentration, the water can readily reach DO concentrations up to 100 mg/L as compared to less than 8 mg/L with air systems in the summer months. High-purity oxygen systems can provide OTE in excess of 80 percent, and provide supersaturated levels across the entire stream cross section. The result is that fewer installations are needed with this technology to maintain a defined DO level (> 5.0 mg/L) along the entire stream.

This subsection outlines alternatives that have been developed to increase dissolved oxygen concentrations utilizing high-purity oxygen. For this discussion, alternatives are grouped into simple oxygenation and bubble oxygenation. For high-purity oxygen, the term oxygenation will replace aeration as an indication of the high purity versus the atmospheric source of oxygen.

### **5.2.1 Simple Oxygenation using High-Purity Oxygen**

Simple oxygenation devices increase DO concentrations by allowing oxygen-deficit water to contact high-purity oxygen as it flows through a sealed chamber. As water drops from the top of the chamber to the bottom, a gas/liquid interface is created by contact between the water and the oxygen source. Low head oxygenators and sealed columns are two examples of devices that can be utilized with high-purity oxygen. These alternatives would most likely be applied in a side-stream setting with pumping due to limitation of sufficient gradient change necessary to drive water through the devices, flow requirements, and navigational issues. Installation of these devices may require site considerations for constructability, maintenance and operation access, storage of supplies, and storage of liquid oxygen.

Advantages of these alternatives include high oxygen transfer efficiency, ease of construction, little navigational impact, and low maintenance due to a limited number of working parts. Disadvantages include potential for debris collection and clogging of the water intake structure, similar to any side-stream technology, and DO levels achieved in the side-stream will be limited to approximately 40 mg/L as they are operated at atmospheric pressures.



**Figure 5-3 - Low Head Oxygenators**

### **5.2.2 Pressurized Oxygenation Using High-Purity Oxygen**

Again using the side-stream approach, but with sealed vessels, the oxygen and water can be introduced at pressures near 100 psig. The solubility of oxygen is proportional to the pressure as well as the oxygen content of the gas feed, so DO levels near 100 mg/L can readily be achieved. This reduces the pumping rate of the withdrawn water, but requires a rapid mix diffuser on the discharge back into the waterway to dissipate the highly enriched oxygenated water before the oxygen is lost to the atmosphere. Oxygenation systems include aeration cones, serpentine pipe mixers, and simply longer runs of pipe with a pressure let down device on the discharge end (for example, eductors). Installation of these devices will require site considerations for constructability, maintenance and operation access, and storage of supplies and liquid oxygen. Both the intake and discharge ends will require routine maintenance to remove debris.

Advantages to pressurized oxygenation devices include low navigational impacts, high oxygen transfer efficiencies, high efficiency at low water depths, and the ability to operate in varying water flows. A disadvantage is the maintenance on the water intake and discharge end.





**Figure 5-4 - Diffuser Used for Bubble Aeration**

### **5.3 Air Supplied Side-Stream Alternatives**

Aeration of side-streams is another technique that can be utilized to increase DO concentrations. Side stream applications involve partitioning a portion of the total river flow off and increasing the dissolved oxygen concentration in that portion. To maintain DO levels above 5.0 mg/L, water withdrawal rates will approach 30 to 50% of the stream flow at low flow conditions, as opposed to only 5 to 10 percent with high-purity oxygen. Higher DO increases are associated with larger volumes of water contacted with the alternative, but fewer overall installations. Specific side-stream applications include side-stream elevated pool aeration (SEPA), pressurized side-stream columns, side-stream channels, and bubble-free aeration; however, all alternatives outlined above can also be implemented as a side-stream alternative with the construction of a side-stream channel adjacent to the existing main riverbed. Advantages of the side-stream applications include potential for community amenity (SEPA has been implemented in the Chicago Metro area and has become a popular attraction), a reduced column of water needed for direct addition of air or oxygen, control over flow conditions, and enhanced ability to supersaturate when utilizing high-purity oxygen (in some cases). Disadvantages include the need for elevation changes necessitating pumping, more fish impingement and entrainment as a result of the larger pumping rates, and the necessity to acquire space adjacent to the main river channel.



**Figure 5-5 - Side-Stream Aeration Facility**

#### **5.4 Overview of Aeration Feasible Alternatives**

From Sections 2 and 3, the lowest DO levels on Salt Creek occur within the impoundment above the Graue Mill Dam. Low DO values have also been noted near Butterfield Road; however, at this location the stream channel has been excessively widened and this could be corrected by restoring the natural channel through this area. In addition, limited DO data above the Oak Meadows dam indicates that lower DO levels also occur in this stretch, the modeling results are consistent with these observations. From a priority perspective, the lowest DO reach should be addressed first, which is the Fullersburg Woods Impoundment above the Graue Mill Dam. The quiescent conditions within the impoundment are ideal for oxygen systems, as minimum DO will be lost to the atmosphere within the impoundment under supersaturated conditions, at least until the water overflows the dam. Side-stream air systems are also possible, but will require pumping rates that will approach the daily flow in Salt Creek. However, the SOD within the impoundment may necessitate more than one side-stream to maintain the DO level above 5.0 mg/L.

Bubble diffusers laid parallel to the flow within the impoundment would also be a viable option, assuming the diffusers do not get covered in silt during high-flow periods. This would have to be demonstrated initially. Surface aerators are not recommended due to aesthetic and maintenance perspectives.

In all cases, the aeration device would be operating in the evening hours. Once photosynthesis begins in the mid-morning, the DO levels would remain above 5.0 mg/L until the early evening hours, when the aeration system would be restarted.

Finally, the question of ownership and operating/maintenance responsibilities will need to be addressed, if this approach is selected. There are electrical costs, potentially oxygen costs, and on-going labor for operation and maintenance. Unlike a dam removal/bridging project, which is basically a one-time cost for removal/modification, in-stream aeration will have on-going costs in perpetuity.

## 6 EVALUATION

The Workgroup started out to improve on the stream DO model used by the Illinois EPA for Salt Creek for low-flow, warm conditions, from which alternatives for improving the DO in Salt Creek could be evaluated. It soon became clear that better data inputs for the model development were necessary. Two years of excellent continuous summer DO data have now been generated, along with SOD data collected during the summers of 2006 and 2007. The result is a model that reasonably predicts observed DO and can reasonable predict conditions during low-flow, warm weather conditions. Concurrently with these DO data collection efforts, the Workgroup collected extensive fish, macroinvertebrate and habitat data on Salt Creek. Analysis of the continuous stream DO monitoring, the DO modeling, and the biological survey data all yield similar findings; that is, the Graue Mill Dam is the single largest impediment to improved water quality and aquatic community integrity on Salt Creek, followed by the Oak Meadows Dam and the wide channelization at Butterfield Road. From a priority perspective, improvements in low flow DO levels should focus on these three areas, in this order. At the Old Oak Brook Dam, the baseline model predicts DO levels during low flow-warm conditions will drop to a minimum of 4.1 mg/L, as compared to the minimums predicted above the Oak Meadows Dam of 3.6 mg/L and above the Graue Mill Dam of 1.2 mg/L. Continuous monitoring at Butterfield Road in 2008 revealed minimum DO values on the order of 2.5 mg/L during low flow conditions. Restoring this stretch to a more natural channel and addressing the low DO values above the Oak Meadows and Graue Mill Dams will result in more benefit to the stream than the lower DO values caused by the Old Oak Brook Dam.

To improve the DO levels within the impoundments, there are a number of options:

- Complete dam removal;
- Periodic dredging;
- Partially breach the dam;
- Bridge the dam; and
- In-stream aeration.

Given the historic value of the Graue Mill Dam, complete dam removal was not considered a viable option at this location, although complete removal is an option for the Oak Meadows Dam. Periodic dredging would require dredging on a two-year cycle, and would do little for improving the biological stream characteristics. Within the Fullersburg Woods Impoundment, the sediment accumulation rate is on the order of 10,000 cu yd per year. To remove this sediment would cost on the order of \$400,000 per year. From both a cost and biological perspective, this option was also rejected.

Partially breaching the dam or enhanced bridging, if done correctly, has the added advantages of allowing fish passage and habitat improvements. Simply raising the DO level within the impoundments via aeration will neither allow fish passage or improvements to feeding and breeding conditions upstream. As discussed in Sections 4 and 5, dam removal/bridging is a one time cost, while aeration has capital and on-going operating/maintenance cost components. As discussed in Section 3, a baseline model was developed based on peak temperature data collected over the most recent ten years and actual 2005 summer pollutant loadings from the POTWs. The

model was then used to evaluate the DO levels that can be achieved from alternatives including dam removal/bridging and in-stream aeration, focusing in on the two most significant impairments to DO, the Graue Mill Dam and the Oak Meadows Dam. In addition, an alternative model was run assuming all of the pollutant loading from the wastewater treatment plants is removed from Salt Creek, while flow is held constant.

### 6.1 Baseline Model

Figure 6-1 presents the baseline conditions, as previously presented in Section 3. This baseline assumes average summer pollutant loadings from the wastewater treatment plants (based on 2005 summer data) and maximum stream temperatures, based on historical data. To achieve the DO water quality standards, the minimum DO is to be maintained above 5.0 mg/L through July 31<sup>st</sup> each year. The minimum DO is located just above the Graue Mill Dam, where minimum DO values of 1.2 mg/L will occur. Above the Oak Meadows Dam, minimum DO levels are predicted to reach 3.6 mg/L, and above the Old Oak Brook Dam, minimum DO levels are predicted to reach 4.1 mg/L. Details on the input to the Baseline Model are provided in Section 3 and Appendix B.

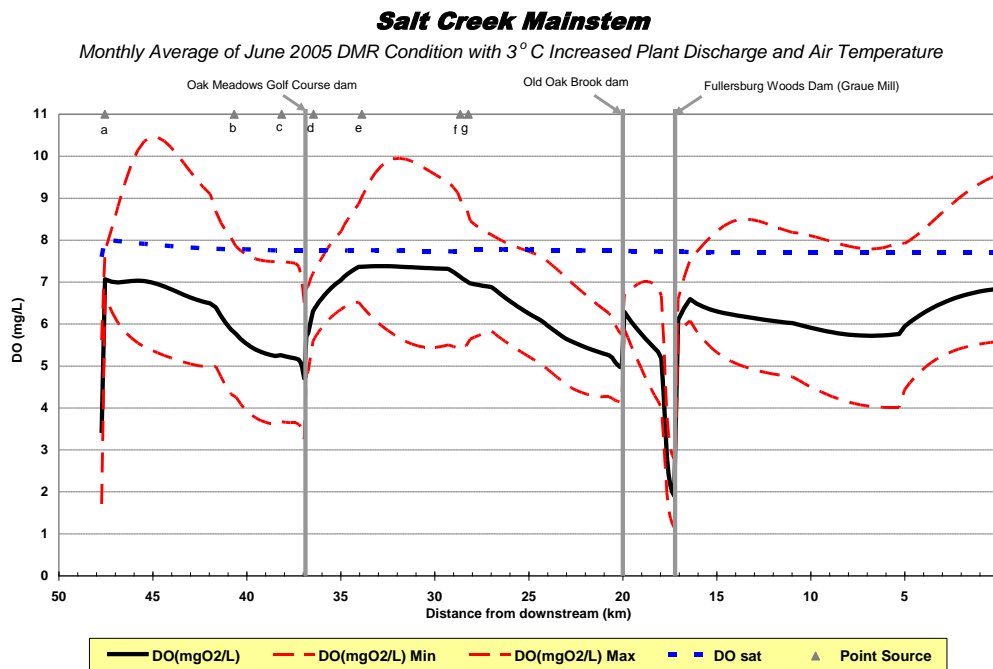
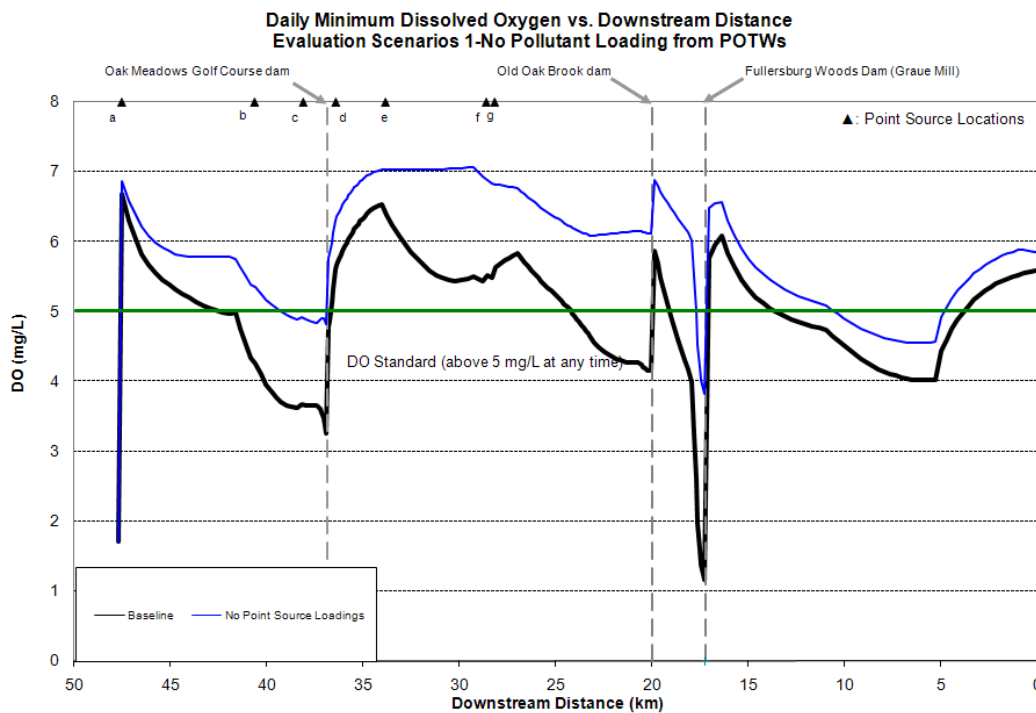


Figure 6-1. Baseline Dissolved Oxygen for Salt Creek

## 6.2 Alternative 1: Eliminate Pollutants in Wastewater Treatment Plant Effluents

For reference purposes, the model was run assuming the wastewater treatment plants maintain their discharges to Salt Creek but reduce all oxygen demanding pollutants and nutrients from their effluents. Figure 6-2 presents a comparison of the baseline model (current worst conditions) to the predicted minimum DO profile. The model predicts improvements to greater than 5.0 mg/L above the Oak Meadows Golf Course and above the Old Oak Brook Dam. Above the Graue Mill Dam, minimum DO is predicted to improve from 1.2 mg/L to 3.8 mg/L. From this simulation, even without any point source pollutants but maintaining flow, the Fullersburg Woods Impoundment will not achieve the Illinois DO water quality standard. In addition it important to note that this alternative does nothing to alleviate the impairment to habitat caused by the dam impoundment and the negative impacts on fish migration posed by the dam.



**Figure 6-2. Baseline Minimum D.O. vs. Downstream Distance**

Table 6-1 presents the estimated costs for achieving essentially zero pollutant discharge. Each of the plants was assumed to be retrofitted with Membrane Bioreactors and polished with granular activated carbon. The estimated capital cost is in excess of \$388,000,000. No estimate of operating costs was made, given the large capital cost and the predicted minimum DO below 5.0 mg/L in the Fullersburg Woods Impoundment.

TABLE 6-1  
SALT CREEK POTW UPGRADE ESTIMATE  
CAPITAL COST FOR MBR & GAC ADDITIONS

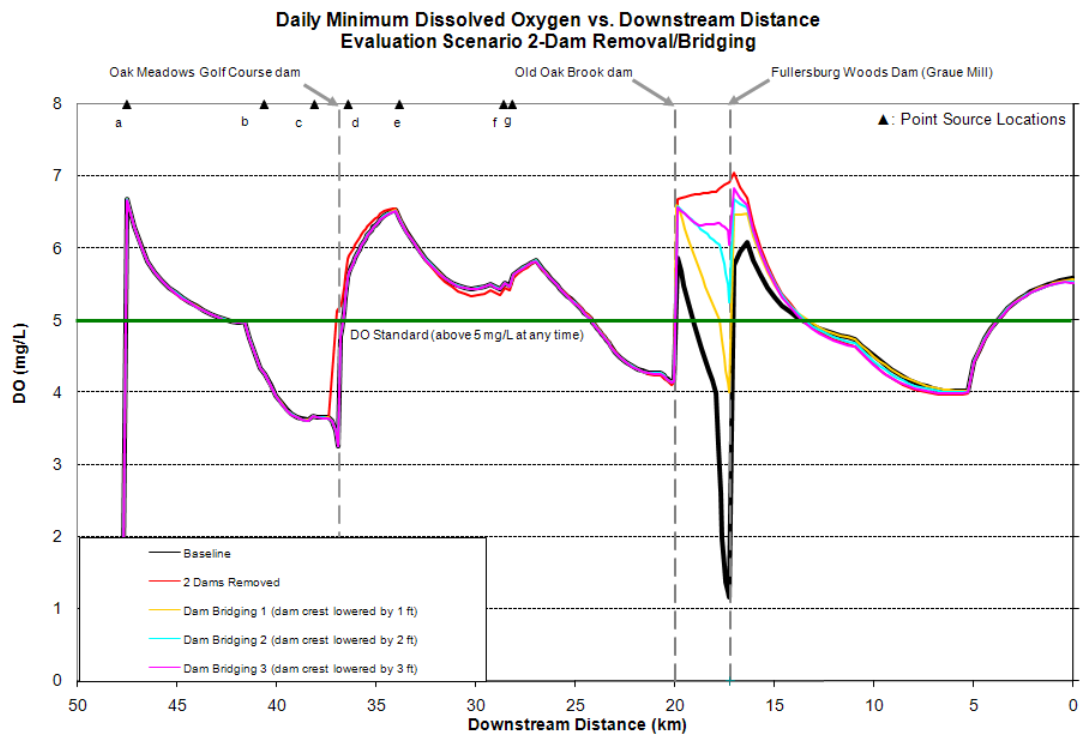
Plant	Design Average Flow, MGD	Design Max Flow, MGD	MBR @ \$2/Gal	GAC @ \$1.50/Gal	Per Plant Total
Egan	30.00	50.00	\$100,000,000	\$75,000,000	\$175,000,000
Nordic Park	0.50	1.00	\$2,000,000	\$1,500,000	\$3,500,000
Itasca	2.60	10.00	\$20,000,000	\$15,000,000	\$35,000,000
Wood Dale N	1.97	3.93	\$7,860,000	\$5,895,000	\$13,755,000
Wood Dale S	1.13	2.33	\$4,660,000	\$3,495,000	\$8,155,000
Addison N	5.30	7.60	\$15,200,000	\$11,400,000	\$26,600,000
Addison S	3.20	8.00	\$16,000,000	\$12,000,000	\$28,000,000
SC SD	3.30	8.00	\$16,000,000	\$12,000,000	\$28,000,000
Elmhurst	8.00	20.00	\$40,000,000	\$30,000,000	\$70,000,000
					\$388,000,000

### 6.3 Alternative 2: Dam Crest Drop or Bridging (Graue Mill Dam) and Removal (Oak Meadows Dam)

Alternative 2 was prepared, assuming dam removal in the case of Oak Meadows, and the lowering of the Graue Mill Dam by 1 ft, 2 ft, and 3 ft. Figure 6-3 presents the minimum DO profile under the various dam removal/bridging options, along with the baseline DO profile. The model predicts the minimum DO above Oak Meadows will still decline to below 4.0 mg/L. This is a location where additional monitoring data would be appropriate. The model predicts that this drop in DO happens nearly 2.5 River Mile (4 km) above the Oak Meadows Dam. This output is suspect, as there is a wastewater treatment plant discharge (the Itasca POTW) at River Mile 25.7 (km 41.4 km), or 2.8 miles (4.5 km) above the Oak Meadows Dam. More recent DO data from the Itasca POTW indicates a minimum DO effluent level of 6 mg/L, and one would expect some distance before 5.0 mg/L would be reached. In addition, this POTW is currently undergoing a significant upgrade that will result in a higher quality effluent than is currently being attained. Below this wastewater treatment plant there is excellent canopy cover until the Oak Meadows Golf Course, conducive to minimizing algal growth. Only two SOD results have been collected above the Oak Meadows Dam at River Mile 23.0 and 22.9 (37.0 and 36.8 km), one a low 0.5 g/m<sup>2</sup>/day and the second 2.27 g/m<sup>2</sup>/day. The model used the highest of these two values, which is likely unrepresentative of the average SOD conditions.

At the Graue Mill Dam, lowering the crest one foot improves the minimum DO to 4.0 mg/L (from 1.2 mg/L), and lowering the crest two feet improves the minimum DO to 5.2 mg/L. If the crest is lowered three ft, the minimum DO is predicted to remain above 6.0 mg/L. Thus, a reduction in crest height of 2 ft at the Graue Mill Dam would result in achieving the Illinois DO

water quality standards, while at the Oak Meadows Dam, the model predicts there will still be minimum DO levels below the 5.0 mg/L.



**Figure 6-3. Dam Removal Minimum D.O. vs. Downstream Distance**

### 6.3.1 Oak Meadows Dam Removal

Aside from needing to perform the project without impinging on golfing operations at the site, the full removal of the Oak Meadows Dam is a simple project and the cost estimate reflects the lack of complexity. The dam itself can be fully removed and the former abutments restored to either match the existing bank treatment (a-jacks on the right and steel sheet pile on the left) or graded for a more natural appearance. Sediment impounded by the dam can likely be stabilized in-situ with careful removal of the dam, and limited excavation will be needed. Some riparian planting upstream within the dewatered channel was assumed in this estimate, though may be either eliminated or enhanced depending on the management goals. Upstream impacts to golf course irrigation ponds may require mitigation if the existing water source is to be used. Incidental bank grading and stabilization as a result of removal was also not accounted for, but should represent a minor contingency in the budget. Sediment behind the dam is assumed to be clean of contaminants that would require special handling. The planning level estimate for design and construction of this project includes \$60,000 for design and permitting and \$190,000 for construction, or a total capital cost of \$250,000. The on shore work would occur during the non-golfing season, mid-November to early April, while the in stream work would need to be done

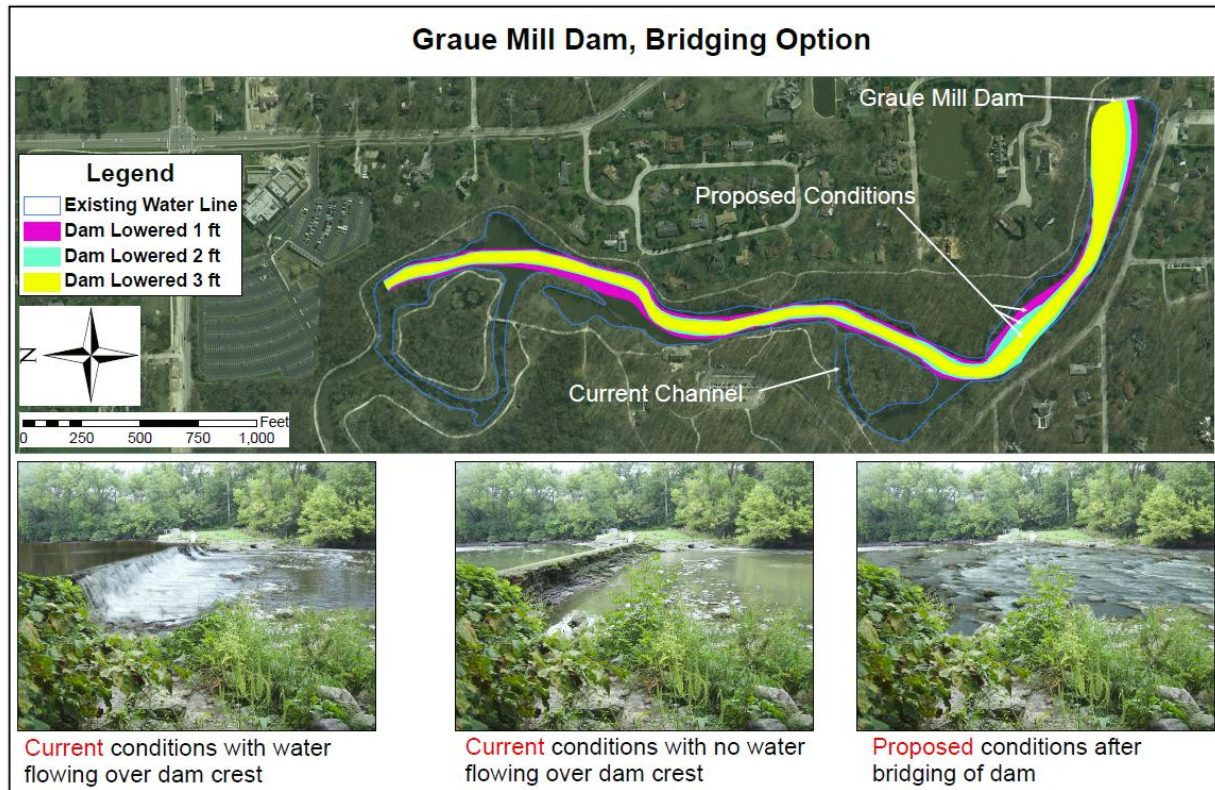
during the lower flow-warmer conditions. There would be no on-going operations or maintenance costs.

### **6.3.2 Graue Mill Dam**

Given the historical and aesthetic value placed on this dam to the community, complete dam removal at this location was not considered as an option beyond the act of modeling. The two options that were considered at the site are bridging or a partial breach. This dam presents a more complex project than the Oak Meadows Dam with associated changes to wetlands and aesthetics that exist currently as a result of the dam. For the purposes of simplifying the cost estimation, given the uncertainty associated with the two approaches presented, a few assumptions were made. First, no active restoration of the channel above the dam was assumed in the estimate. The upstream channel can be actively or passively restored based on the management goals of the Forest Preserve District of DuPage County. Second, an estimate for any modification to the existing sluice way required to provide head to drive the water wheel was not included in the estimate, since specific solutions to this have not been investigated in detail. Last, any amenities, including adding a recirculating pump to spill water over the remaining crest of the dam (under the breach option) were not included. The cost estimates for both alternatives assume approximately \$200,000 for design and permitting, variations in this cost are expected to be minor between the two options. Costs for seeding and dealing with invasive plant species have also not been included in the estimate.

Bridging would lower the crest of the dam by approximately 2 to 3 feet and fill the downstream face with rock, creating a riffle or bridge between the upstream and downstream sections. A new water surface elevation upstream would result in the need for riparian re-vegetation and control of invasive species. Since the spillway would be backfilled with rock on the downstream side, additional buttressing to address stability of the dam would not be required. The rock fill would be rounded, glacial stone, representing a substantial portion of the overall construction budget. Estimated costs for the design and construction of the bridging option range from \$800,000 – \$1,100,000. Figure 6-4 depicts the footprint of the Fullersburg Impoundment under the various lowering of the dam height scenarios.

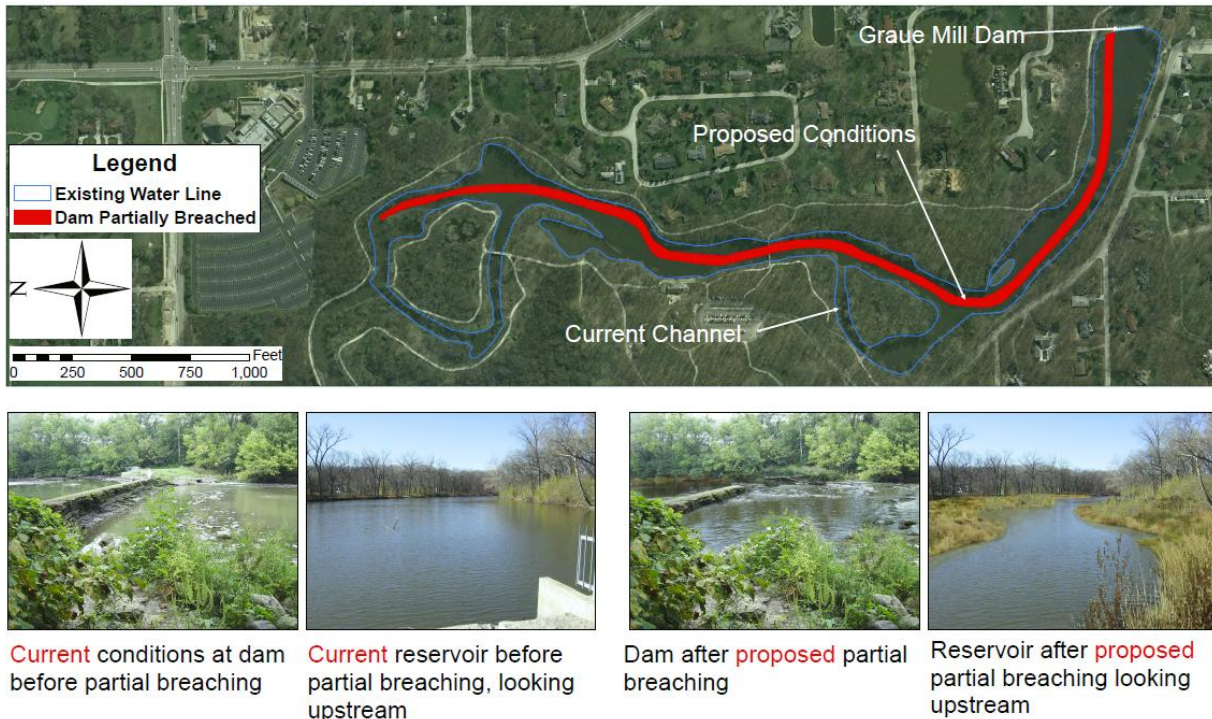




**Figure 6-4. Fullersburg Woods Footprint with Lowered Dam Elevations**

A partial breach of the dam would occur on the left (north east) bank, removing the existing dewatering structure and removing a portion of the existing dam. The amount of exposed (former) impoundment upstream of the dam would be larger than under the bridging option and represents a substantial portion of the estimated cost. Again no channel restoration upstream of the existing dam is assumed in this scenario. The estimated cost range for designing and constructing a partial breach of the dam is \$300,000 - \$600,000. Figure 6-5 depicts the stream channel through the area of the Fullersburg Woods Impoundment if the dam is breached.

### Graue Mill Dam, Partial Breaching Option



**Figure 6-5. Fullersburg Woods Footprint with Breaching Option**

Depending on the final design there would also be perpetual operating costs associated with pumping if utilized for the water wheel and/or to pass over the spillway. These costs are estimated at \$20,000 per year.

## 6.4 Alternative 3: In-stream Aeration Using Air-Based Technology

In-stream aeration is presented as Alternative 3, and the resulting DO trend is depicted in Figure 6-4 for the daily minimum prediction using air-based technology. Raising the DO levels from 5.0 to 6.0 mg/L at a single location above each of the two dam results in some improvement in overall DO levels but does not achieve state water quality standards through the entire length that is below the 5.0 mg/L level.

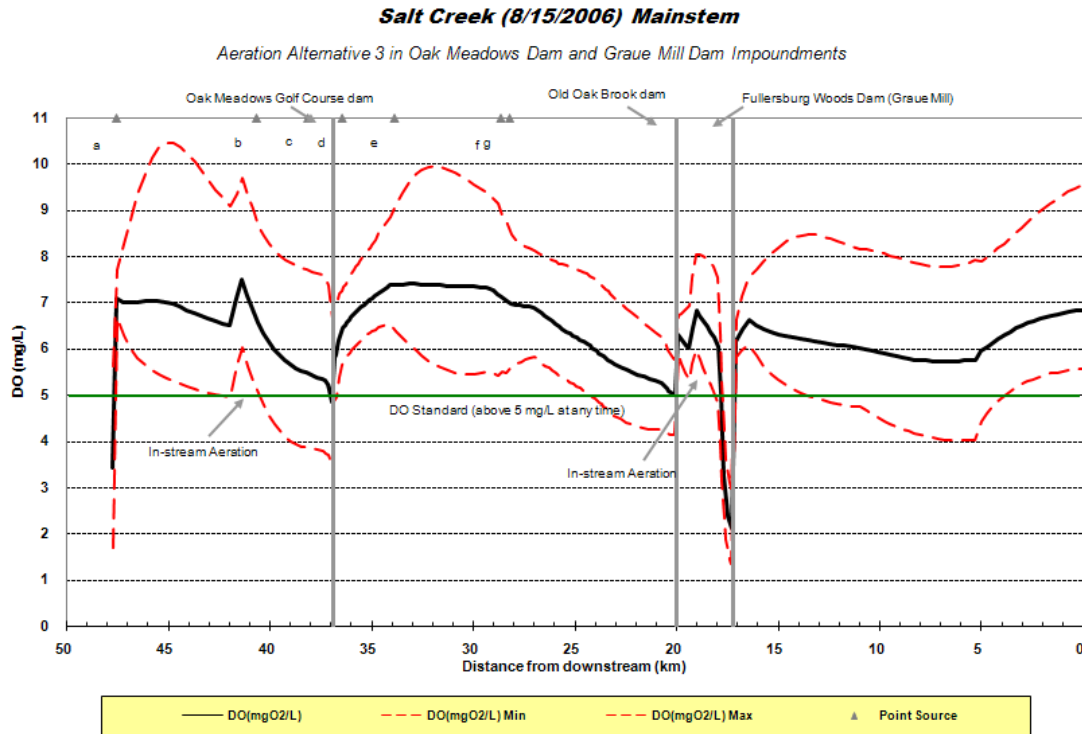
### 6.4.1 Oak Meadows Golf Course Dam

As discussed previously, any supplemental aeration technology needs to be applied at locations where the DO first dips to 5.0 mg/L, and the modeling predicts this happens nearly 2.5 miles (4 km) above the Oak Meadows Dam. As noted previously, this location is suspect as there is a wastewater treatment plant discharge (the Itasca POTW) at River Mile 25.7 (41.4 km), or 2.8 miles (4.5 km) above the Oak Meadows Dam. More recent DO data from the Itasca POTW indicates a minimum DO effluent level of 6 mg/L, and one would expect some distance before 5.0 mg/L would be reached. In addition, this POTW is currently undergoing a significant upgrade that will result in a higher quality effluent than is currently being attained.

Below the POTW there is excellent canopy cover until the Oak Meadows Golf Course, and algal and plant growth in the stream would be expected to be minimal under this canopy cover.

The shallow nature of the stream above the Oak Meadows Dam limits the possible air-based technologies. If side-stream aeration is selected, the withdrawal rate will be approximately 50% of the low flow, or 14 MGD (0.6 m<sup>3</sup>/s). Such a high withdrawal rate will require a fine screen to avoid fish impingement, and with the debris that accumulates on the screen an automatic cleaning screen will be necessary. Fine bubble tubing, as illustrated in Figure 5-2, would avoid the potential for fish damage and high maintenance for the screen. Approximately 1,200 ft (400 m) of fine bubble tubing would be necessary above Oak Meadows to raise the DO from 5.0 to 6.0 mg/L and a 10 HP blower plus one spare would be required. The blowers would be housed in a small building with a header laid on the floor of the Salt Creek, with the tubing extending downstream. Tubing runs of 300 ft (100 m) are acceptable, therefore, there would be 4 aeration tubings extending downstream.

Figure 6-6 presents the predicted DO improvement with air-based technology. The model predicts the minimum DO drops below 5.0 mg/L 3.1 miles (5 km) above the Oak Meadows Dam. In an ideal situation, this is where the in-stream aeration would be located. However, this is just above the Itasca Wastewater Treatment Plant, where the stream DO level is expected to increase to above 6.0 mg/L from the treatment plant discharge. As noted previously, the SOD value used above this dam in the model was the higher of only two results, and therefore may be overly conservative. Above Oak Meadows a potential location for this would be at the north end of the Oak Meadows Golf Course, along Elizabeth Drive, approximately 0.94 miles (1.5 km) above the Oak Meadows Dam. There is access at this location, and power could be run in from along Addison Road. From the modeling, if the DO is raised from 5.0 to 6.0 mg/L at this location, the benefit would carry 0.8 stream miles (1.3 km) downstream. From an accuracy perspective, this would carry the DO improvement to within 0.14 stream miles (0.2 km) of the dam, so DO would be expected to remain above 5.0 mg/L in all but the warmest extended periods. This location is also the beginning of where minimum DO values actually fall below 5.0 mg/L, due to the lack of canopy cover through this stretch of Salt Creek.



**Figure 6-6. Aeration Alternative Minimum D.O. vs. Downstream Distance**

The capital cost for a single installation above Oak Meadows is estimated at \$470,000 and the annual operating cost would be \$100,000 per year. The net present value over 20 years would be \$1,190,000, assuming only one installation is necessary. If a second air-based system is necessary, these costs would nearly double, to \$800,000 capital and a net present value of \$2,050,000. The cost for one installation above Oak Meadows is presented in Table 6-2.

### 6.4.2 Graue Mill Dam

In the Fullersburg Woods impoundment, the minimum DO drops below 5.0 mg/L approximately 1.25 stream miles (2.0 km) above the Graue Mill Dam. Two air-based in-stream aeration systems will be required to maintain the DO above 5.0 mg/L with the second one located less than 0.3 miles (0.5 km) above the dam. Within the impoundment, sediment levels are thicker and sediment deposition over the aeration tubing during the periods not in operation will be a concern. However, the water column depth is greater than above the Oak Meadows Dam, so the oxygen transfer efficiency will be greater. When the aeration tubing is first started up in May/June, re-suspension of sediment will occur for a short period of time. It is likely that the tubing will have to be physically removed each fall, and re-installed in the late spring to maintain its efficiency, which was factored into the costs.

Table 6-3 presents the capital, operating, and net present value for two in-stream aeration systems in the Fullersburg Woods impoundment. The estimated capital cost is \$800,000, and the annual operating cost is estimated at \$100,000. The net present value over the next twenty years is \$2,050,000.

TABLE 6-2  
INSTREAM AERATION AT OAK MEADOWS  
USING FINE BUBBLE TUBING AND AIR

Assumptions

- 1) 210 lbs per oxygen transferred per day required, per location
- 2) Assume 2.2 lbs of oxygen transferred per hr per hp can be achieved
- 3) Assume average depth of 3 ft attainable at location of tubing
- 4) Electrical cost in summer \$.10 per kwhr
- 5) Target DO not allowed to drop below 5 mg/L in June and July

CAPITAL COST				
	Number	Units	Unit Cost	Cost
Land	0.5	acres	\$ 50,000.00	\$ 25,000.00
Blower building	1	bldg	\$ 60,000.00	\$ 60,000.00
Blower piping	150	ft	\$ 100.00	\$ 15,000.00
Blower header	1	header	\$ 10,000.00	\$ 10,000.00
Trenching & Restoration	150	ft	\$ 40.00	\$ 6,000.00
Blowers-10 hp each	4		\$ 10,000.00	\$ 40,000.00
Bubble diffusers,purchase	1200	ft	\$ 6.00	\$ 7,200.00
Bubble diffuser installation	4	mandays	\$ 800.00	\$ 3,200.00
Electrical	1		\$ 60,000.00	\$ 60,000.00
Design				\$ 40,000.00
Permitting				\$ 10,000.00
WetlandsMitigation				\$ 20,000.00
Controls & Telemeter	1	each	25000	\$ 25,000.00
Access Road	1		30000	\$ 30,000.00
Erosion control				\$ 10,000.00
Sub-Total				\$ 361,400.00
Contingency	0.3			\$ 108,420.00
<b>Total</b>				<b>\$ 470,000.00</b>
Annual cost				
Electrical	120	days	\$18.00	\$2,160.00
Operating Labor	320	hrs/yr	50	\$ 16,000.00
Maintenance	320	hrs/yr	50	\$ 16,000.00
Replacement Costs	5%	of capital		\$ 23,500.00
<b>Total Annual cost</b>				<b>\$58,000.00</b>
Net present value over 20 years				
Capital Cost				\$ 470,000.00
Present Value from Annual	\$ 58,000.00	5%	12.466	\$ 723,028.00
<b>Net Present Value</b>				<b>\$ 1,190,000.00</b>

TABLE 6-3  
INSTREAM AERATION AT GRAUE MILL  
USING FINE BUBBLE TUBING AND AIR

Assumptions

- 1) 325 lbs per oxygen transferred per day required, per station or 650 lb/day total.
- 2) Assume 2.2 lbs of oxygen transferred per hr per hp can be achieved
- 3) Assume average depth of 4 ft attainable at location of tubing
- 4) Electrical cost in summer \$.10 per kwhr
- 5) Target DO not allowed to drop below 5 mg/L in June and July

<b>CAPITAL COST</b>				
	Number	Units	Unit Cost	Cost
Land	1	acre	\$ 50,000.00	\$ 50,000.00
Blower building	2	bldg	\$ 60,000.00	\$ 120,000.00
Blower piping	300	ft	\$ 100.00	\$ 30,000.00
Blower header	2	header	\$ 10,000.00	\$ 20,000.00
Trenching & Restoration	300	ft	\$ 40.00	\$ 12,000.00
Blowers-15 hp each	4		\$ 10,000.00	\$ 40,000.00
Bubble diffusers,purchase	3000	ft	\$ 6.00	\$ 18,000.00
Bubble diffuser installation	10	mandays	\$ 800.00	\$ 8,000.00
Electrical	2		\$ 60,000.00	\$ 120,000.00
Design				\$ 50,000.00
Permitting				\$ 20,000.00
WetlandsMitigation				\$ 40,000.00
Controls & Telemeter				\$ 40,000.00
Access Road	2		30000	\$ 60,000.00
Erosion control				\$ 20,000.00
Sub-Total				\$ 648,000.00
Contingency	0.3			\$ 194,400.00
<b>Total</b>				<b>\$ 800,000.00</b>
Annual cost				
Electrical	120	days	\$54.00	\$6,480.00
Operating Labor	700	hrs/yr	50	\$ 35,000.00
Maintenance	640	hrs/yr	50	\$ 32,000.00
Replacement Costs	5%	of capital		\$ 40,000.00
<b>Total Annual cost</b>				<b>\$100,000.00</b>
Net present value over 20 years				
Capital Cost				\$ 800,000.00
Present Value from Annual	\$ 100,000.00	5%	12.466	\$ 1,246,600.00
<b>Net Present Value</b>				<b>\$ 2,050,000.00</b>

### **6.4.3 Flood Control Reservoirs Use During Low Flow-Warm Conditions**

Although beyond the current scope of work, the two flood control reservoirs (Wood Dale Itasca Reservoir and the Elmhurst Quarry) offer the potential to improve DO levels during the warmer dry weather periods. Routine pumping of groundwater from the Elmhurst Quarry occurs, and the existing outfall passes over a cascading aerator. If pumping could be conducted during the evening hours, flow during the critical diurnal DO periods could be supplemented, bringing in additional oxygen and reducing retention time through areas like Butterfield Road during these similar conditions. Whether a similar approach at Wood Dale Itasca Reservoir could also be done has not been investigated, but has the potential of increasing DO in the stretch above the Oak Meadows Dam would suggest this should also be explored.

## **6.5 Alternative 4: High-Purity Oxygen**

The advantage of high-purity oxygen is that higher initial DO levels in the stream are possible, typically up to 150 percent of saturation, resulting in maintaining minimum DO levels above 5.0 mg/L for longer stream reaches. Thus fewer installations are required. Figure 6-7 depicts the DO profile in Salt Creek, assuming high-purity oxygen injections above Oak Meadows and Graue Mill Dams.

### **6.5.1 Oak Meadows Golf Course Dam**

Raising the DO from 5 to 12 mg/L above Oak Meadows carries 2.5 miles (4 km), so only one installation would be necessary. The capital cost is estimated at \$460,000 (Table 6-4), and the annual operating cost is estimated at \$76,000 per year. A total of 110,000 pounds of high-purity oxygen would be injected annually. The net present value over 20 years is estimated at \$1,410,000.

### **6.5.2 Graue Mill Dam**

In the Fullersburg Woods impoundment, the benefit of oxygen injection carries 1.25 miles (2 km), as depicted in Figure 6-5. Such improvement would be expected to result in all of the Fullersburg Woods impoundment maintaining minimum DO levels above 5.0 mg/L except for during the warmest prolonged dry periods, when the model predicts DO levels near the dam itself would fall to approximately 3.0 mg/L (compared to 1.2 mg/L currently). The capital cost for a single high-purity oxygen system is estimated at \$500,000, and the annual operating cost would be on the order of \$97,000. Oxygen injection would be on the order of 330,000 pounds per year. Over a twenty year period, the net present value for oxygen addition at within the Fullersburg Impoundment would be \$1,710,000.

TABLE 6-4  
HIGH-PURITY OXYGEN ADDITION AT OAK MEADOWS

Assumptions

- 1) 1,456 lbs per day required per CW.
- 2) O2 transfer efficiency of 80 %, so consumption 1,820 lbs per day
- 3) density of LOX is 9.5 lbs per gal, so consumption will be 290 gallons per day
- 4) There are 12 cu ft per pound
- 5) Price of Oxygen is \$0.05 per pound
- 6) Over a four month period, at 1,820 lbs per day, operated 12 hours per day, need 110,000 pounds per yr
- 7) Lease 2-6,000 gallon tanks, or 18,000 gallon capacity, or one year supply
- 8) DO not allowed to drop below 5 mg/L in June and July
- 9) Assume one system placed at northern edge of golf course

CAPITAL COST				
	Number	Units	Unit Cost	Cost
Land	0.5	acres	\$ 50,000.00	\$ 25,000.00
Concrete Pads	2	10 x 10	\$ 4,000.00	\$ 8,000.00
Piping				\$ 25,000.00
Insulation				\$ 5,000.00
Trenching				\$ 8,000.00
Pumps	2		\$ 5,000.00	\$ 10,000.00
Intake structures	1		\$ 20,000.00	\$ 20,000.00
Eductors installation	1		\$ 30,000.00	\$ 30,000.00
Electrical	1		\$ 60,000.00	\$ 60,000.00
Design				\$ 50,000.00
Permitting				\$ 10,000.00
WetlandsMitigation				\$ 20,000.00
Controls & Telemeter				\$ 25,000.00
Fencing	1		15000	\$ 15,000.00
Access Road	1		30000	\$ 30,000.00
Erosion control				\$ 10,000.00
Sub-Total				\$ 351,000.00
Contingency	0.3			\$ 105,300.00
<b>Total</b>				<b>\$ 460,000.00</b>
<b>ANNUAL COST</b>				
Lease 2 -6000 gal Cryogenic tanks	2	6,000 gal	\$ 6,500.00	\$ 13,000.00
Oxygen	110000	lbs	\$0.06	\$6,600.00
Electrical	100	KW/hr/day	\$0.10	\$1,200.00
Operating Labor	320	hrs/yr	50	\$ 16,000.00
Maintenance	320	hrs/yr	50	\$ 16,000.00
Replacement Costs	5%	of capital		\$ 23,000.00
<b>Total Annual cost</b>				<b>\$ 76,000.00</b>
Net present value over 20 years				
Capital Cost				\$ 460,000.00
Presnt of Annual	\$ 76,000.00	5%	12.466	\$ 950,000.00
<b>Net Present Value</b>				<b>\$ 1,410,000.00</b>



TABLE 6-5  
HIGH-PURITY OXYGEN ADDITION AT GRAUE MILL

Assumptions

- 1) 2,200 lbs per day required
- 2) O<sub>2</sub> transfer efficiency of 80 %, so consumption 2,750 lbs per day
- 3) density of LOX is 9.5 lbs per gal, so consumption will be 290 gallons per day
- 4) There are 12 cu ft per pound
- 5) Price of Oxygen is \$0.05 per pound
- 6) Over a four month period, at 2,750 lbs per day need 330,000 pounds per yr
- 7) Lease 2-9,000 gallon tanks, or 18,000 gallon capacity, or 62 day supply
- 8) DO not allowed to drop below 5 mg/L in June and July, system required 24 hour per day
- 9) Assume one system placed along pool at Fullersburg Woods where DO declines below 5 mg/L

CAPITAL COST				
	Number	Units	Unit Cost	Cost
Land	0.5	acres	\$ 50,000.00	\$ 25,000.00
Concrete Pads	2	15x15 ft	\$ 5,000.00	\$ 10,000.00
Piping				\$ 25,000.00
Insulation				\$ 5,000.00
Trenching				\$ 8,000.00
Pumps	2		\$ 5,000.00	\$ 10,000.00
Intake structures	1		\$ 25,000.00	\$ 25,000.00
Eductors installation	1		\$ 50,000.00	\$ 50,000.00
Electrical	1		\$ 50,000.00	\$ 50,000.00
Design				\$ 50,000.00
Permitting				\$ 10,000.00
WetlandsMitigation				\$ 25,000.00
Controls & Telemeter				\$ 25,000.00
Fencing	1		15000	\$ 15,000.00
Access Road	1		40000	\$ 40,000.00
Erosion control				\$ 10,000.00
Sub-Total				\$ 383,000.00
Contingency	0.3			\$ 114,900.00
<b>Total</b>				<b>\$ 500,000.00</b>
<b>ANNUAL COST</b>				
Lease 2 -9,000 gal Cryogenic tanks	2	9000 gal	8100	\$ 16,200.00
Oxygen	330000	lbs	\$0.06	\$19,800.00
Electical	300	kwh/day	\$0.10	\$3,600.00
Operating Labor	320	hrs/yr	50	\$ 16,000.00
Maintenance	320	hrs/yr	50	\$ 16,000.00
Replacement Costs	5%	of capital		\$ 25,000.00
<b>Total Annual cost</b>				<b>\$ 97,000.00</b>
Net present value over 20 years				
Capital Cost				\$ 500,000.00
Presnt of Annual	\$ 97,000.00	5%	12.466	\$ 1,210,000.00
<b>Net Present Value</b>				<b>\$ 1,710,000.00</b>

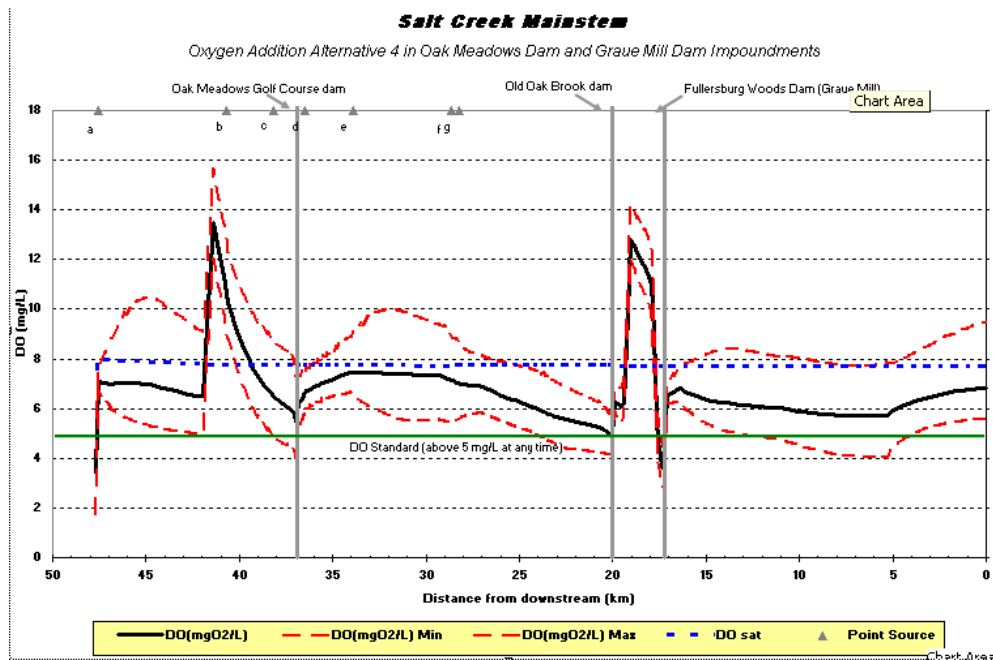


Figure 6-7. Oxygen Addition Alternative Minimum D.O. vs. Downstream Distance

## 6.6 Summary of Options

Four options have been evaluated to increase the dissolved oxygen at the lowest points on Salt Creek. For comparison purposes, the net present value of each alternative can be compared. Where there are no on-going operating costs, the net present value was set equal to the capital cost. Not all options will achieve the desired minimum DO of 5.0 mg/L in the June and July months. A summary of the net present values is as follows:

Option	Net Present Value, \$	DO Compliance	Habitat Impact	Fish Passage
1-Eliminate Point Source Pollutants	> \$388,000,000	Not in the Fullersburg Woods Impoundment	No change	No
2-Oak Meadows Dam Removal and Bridging/Partial breach at Graue Mill	OM-\$250,000 GM-\$800,000 to \$1,100,000	Likely achieved above OM, achieved in Fullersburg Woods Impoundment. Not in Butterfield Rd to Old Oak Brook Dam	Im-proved	Yes
3-Air based In-stream Aeration	OM-\$1,190,000 GM-\$2,050,000	OM-Yes (1 or 2 units) GM-Yes. No-Butterfield Rd to Old Oak Brook Dam	No	No
4-High purity Oxygen Addition	OM-\$1,410,000 GM-\$1,710,000	OM-Yes GM-Yes No-Butterfield to Old Oak Brook Dam	No	No

The low cost option at the Oak Meadows Dam is to remove this dam, which has a net present value of \$250,000. The next lowest option is air based in-stream aeration assuming one installation will be sufficient to maintain the DO above 5.0 mg/L.

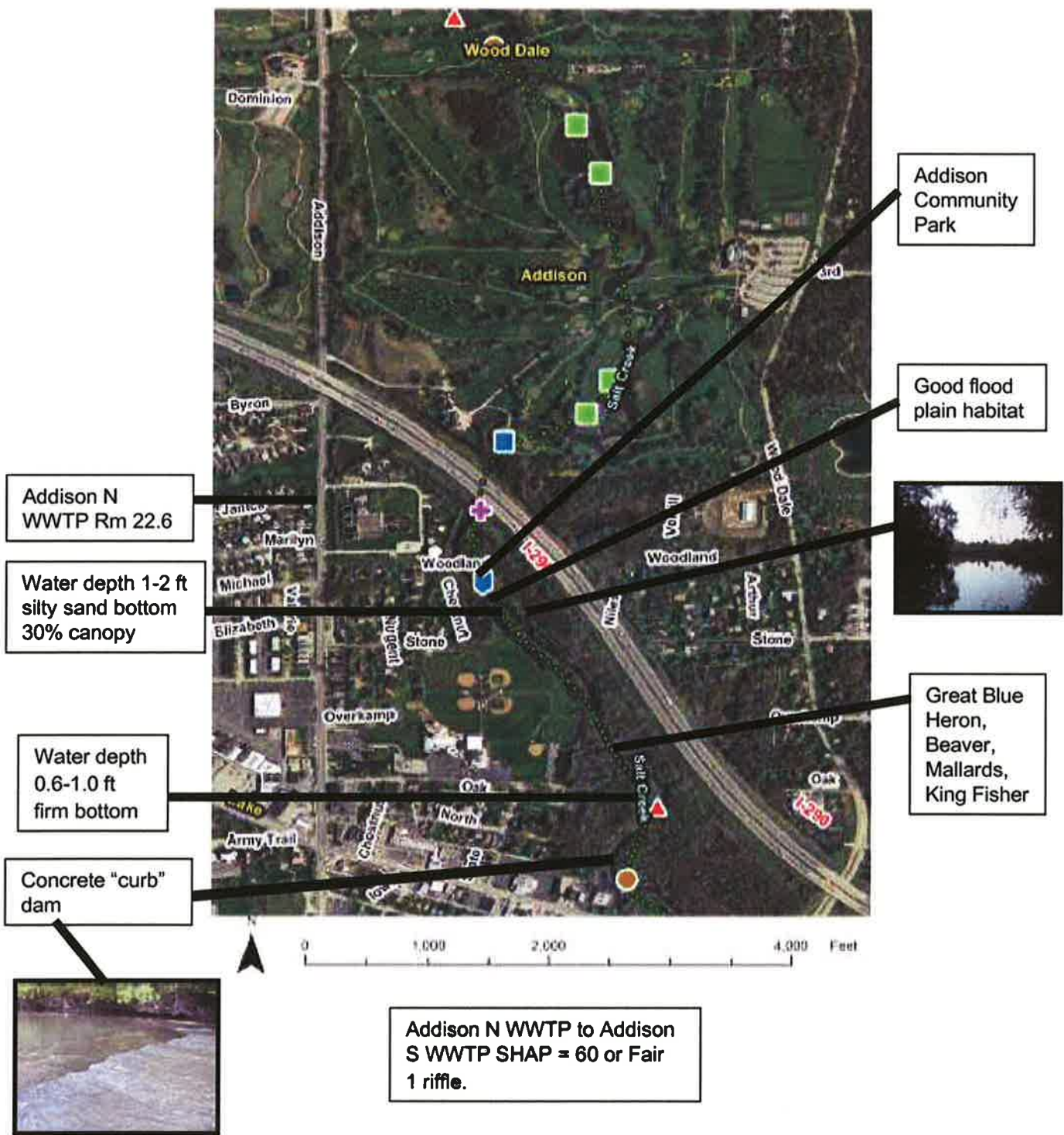
At Graue Mill bridging or partial breaching of the dam is also the lowest cost option, with a net present value of between \$800,000 and \$1,100,000. High-purity oxygen is the second lowest cost option, with a net present value of \$1,710,000, assuming that one system can maintain the DO above 5.0 mg/L adjacent to the dam.

As discussed previously, complete dam removal has the advantage of improving the fish and benthic qualities upstream of the dam. Also, as discussed in Section 2.5.1, the Oak Meadows Dam is in need of repair, and there are on-going costs associated with maintaining this dam. If supplemental oxygen addition is selected, there are on-going operational costs that some entity will have to assume responsibility for as well as the on-going costs. This is more complicated than the dam removal/bridging/partial breach option, where the costs are all associated with the initial capital costs. Based on the recent dam removal projects within DuPage County, funding assistance from both the State and Federal Governments for the capital costs have been successfully secured. It is doubtful that for operating costs that such external funding sources will be available.

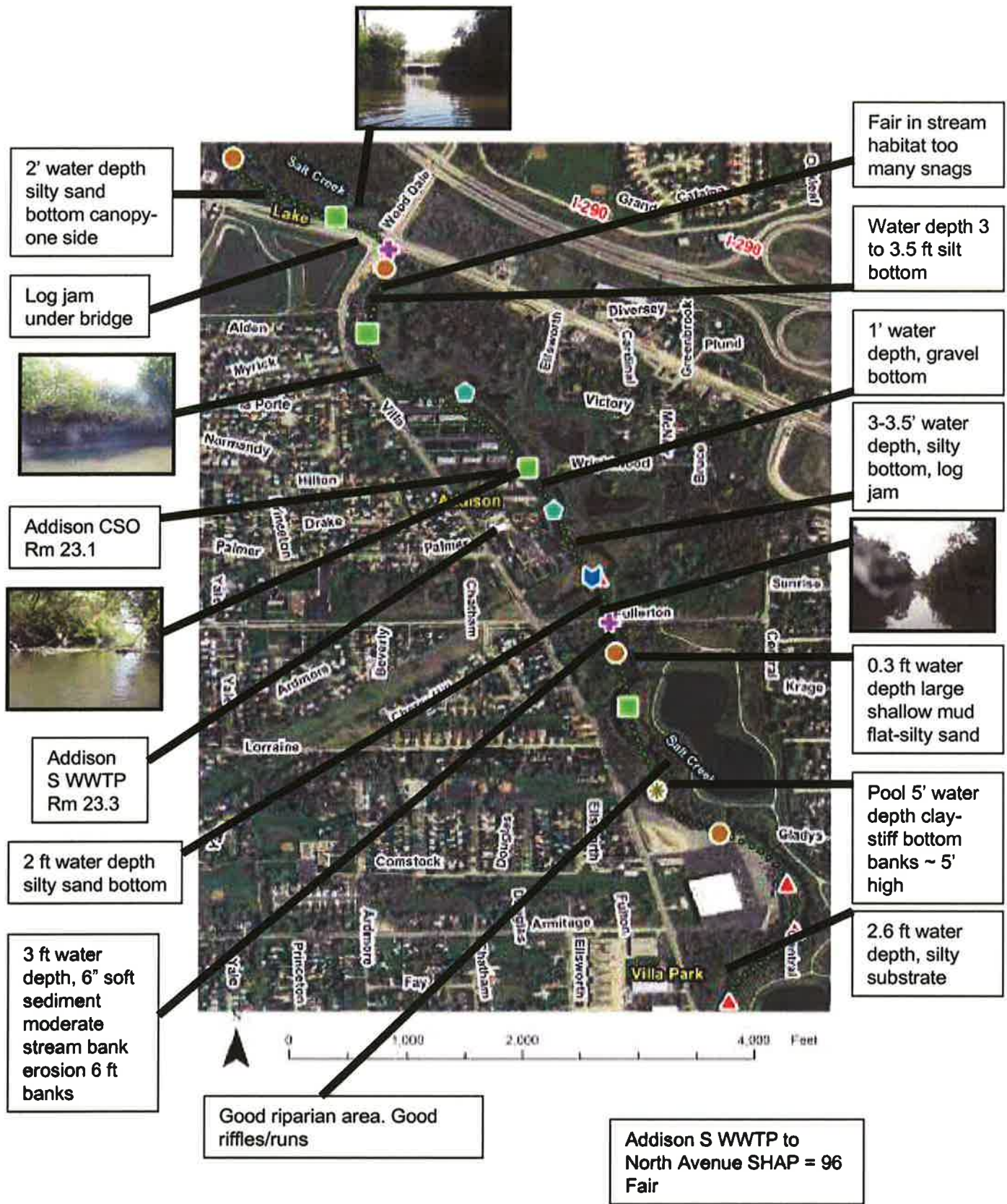
Implementation will depend first on reaching consensus of the stakeholders. Given the location and condition of the Oak Meadows Dam, support for removal is expected to be strong among the stakeholders. Funding will be the key to implementation. DuPage County Division of Stormwater Management is currently managing two dam removal projects. It is recommended that these projects be completed so that the water quality benefits can be measured and confirmed before proceeding with any of the recommended projects contained in this report.

Graue Mill Dam has a significant historical component and local interest in preserving this dam is high. Several public outreach meetings have been held in the local community, and comments were received on the value of this dam to the community from a historical perspective and an aesthetic perspective. These comments are summarized in Appendix D. It is clear from these meetings that building a consensus on how best to address the water quality issues while preserving the historical and aesthetic value of the dam/impoundment will require significant effort that will need to be expended before proceeding in any direction at this location. The dewatering gates at the site provide the opportunity to draw water levels down and observe what habitat is available as well as gauge impacts on DO. The idea of using these gates was raised at both the DRSCW DO Committee and the public meetings.

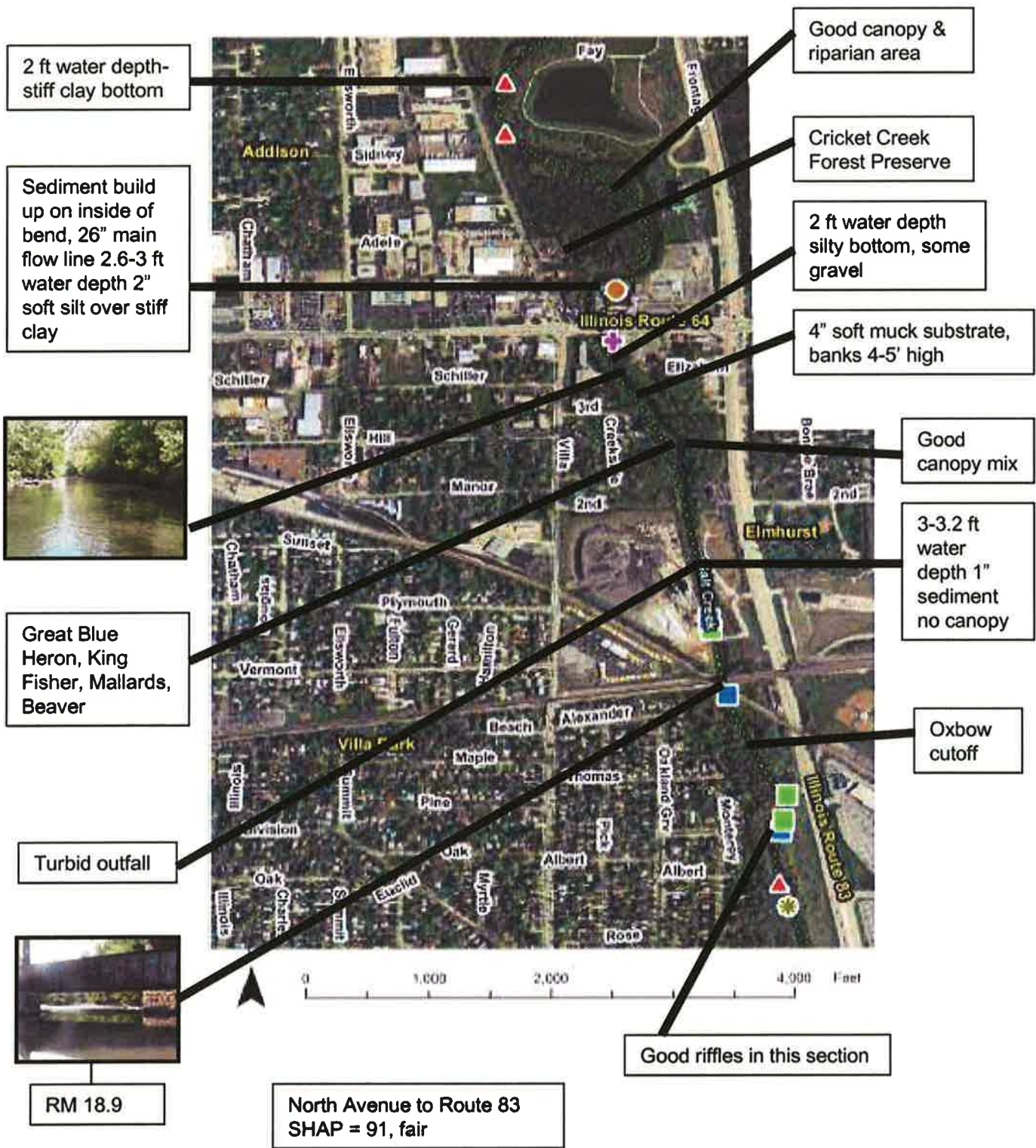
# Appendix A



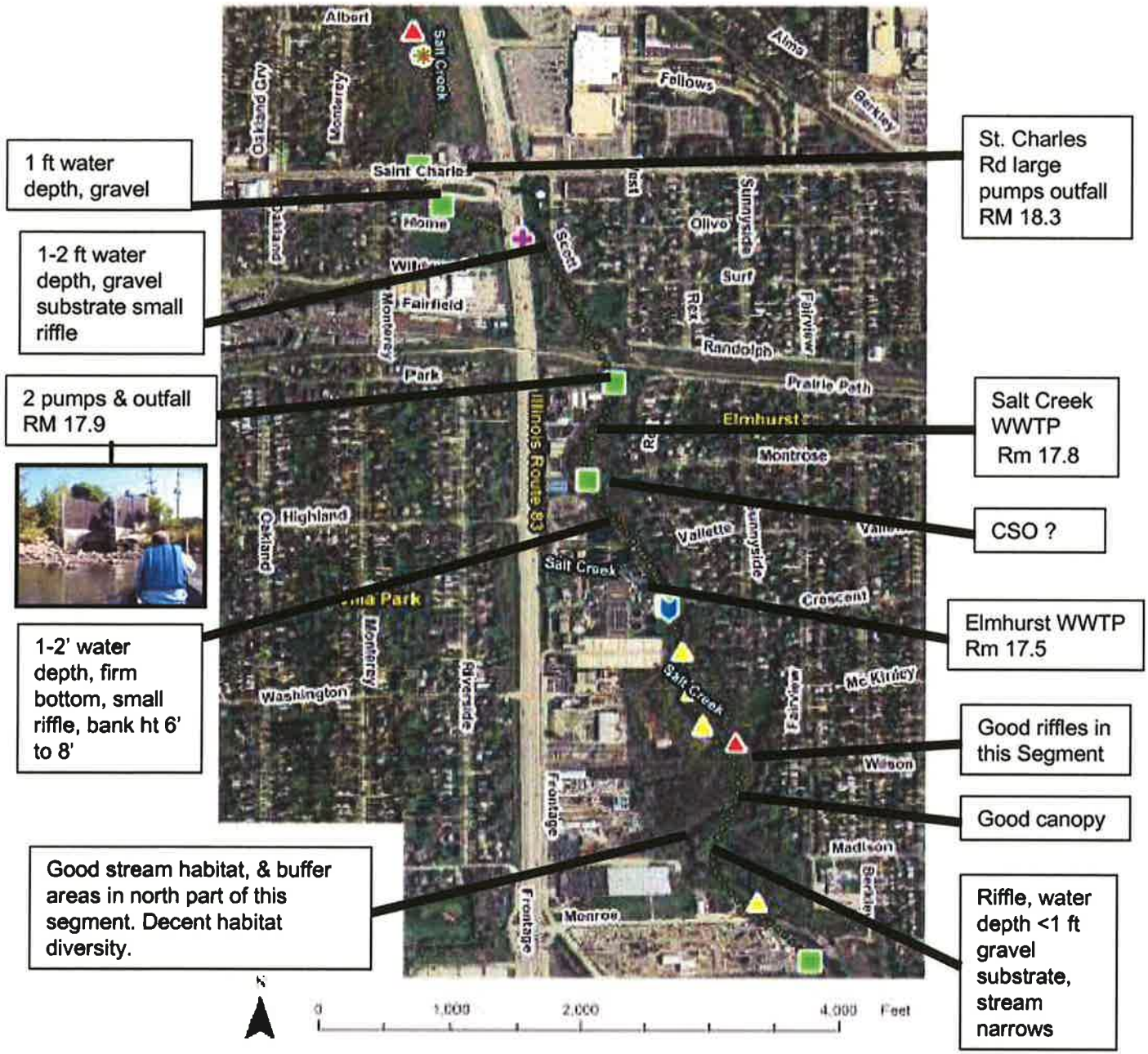
**FIGURE 2.1**  
**SALT CREEK**



**FIGURE 2.2**  
**SALT CREEK**



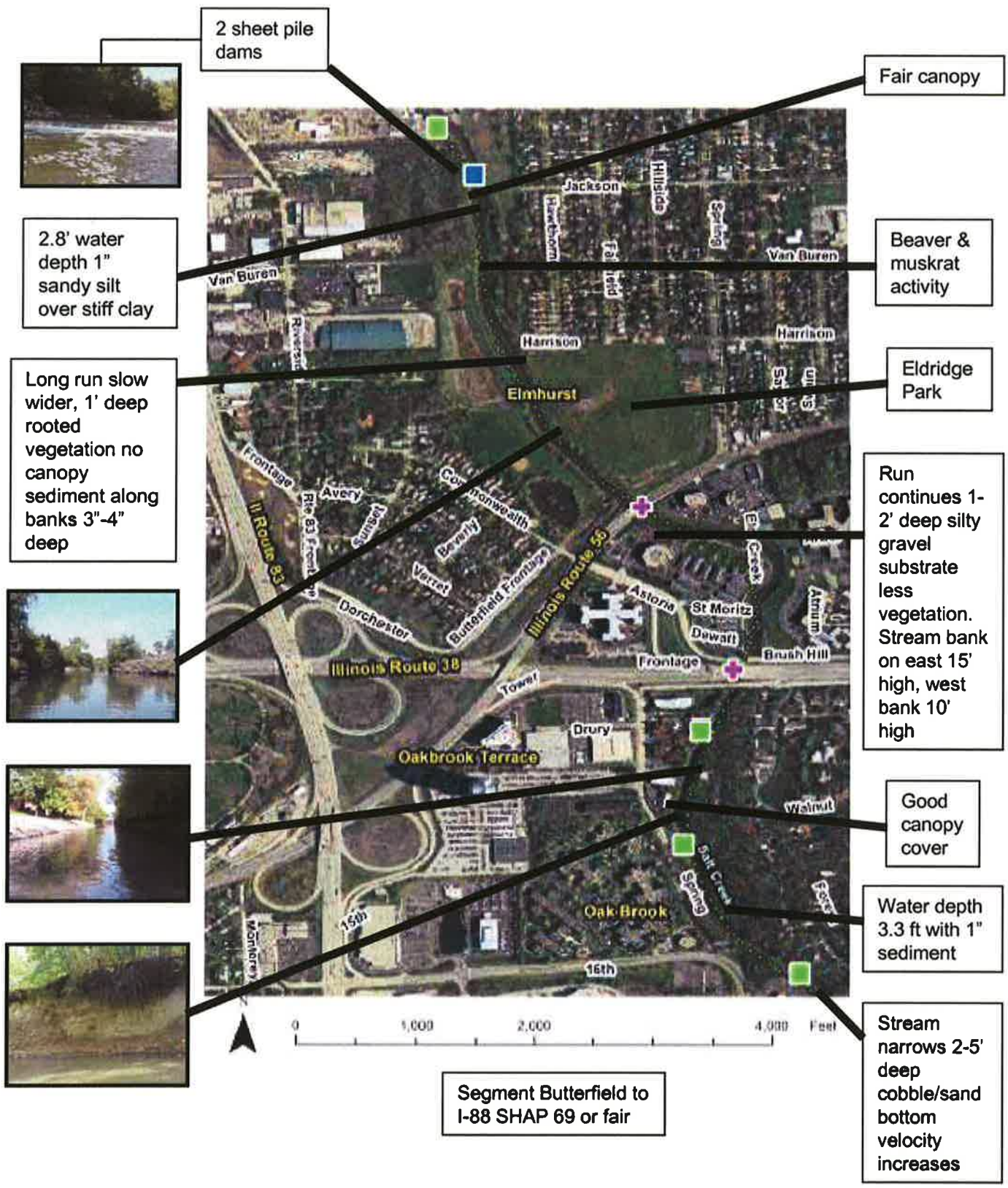
**FIGURE 2.3**  
**SALT CREEK**



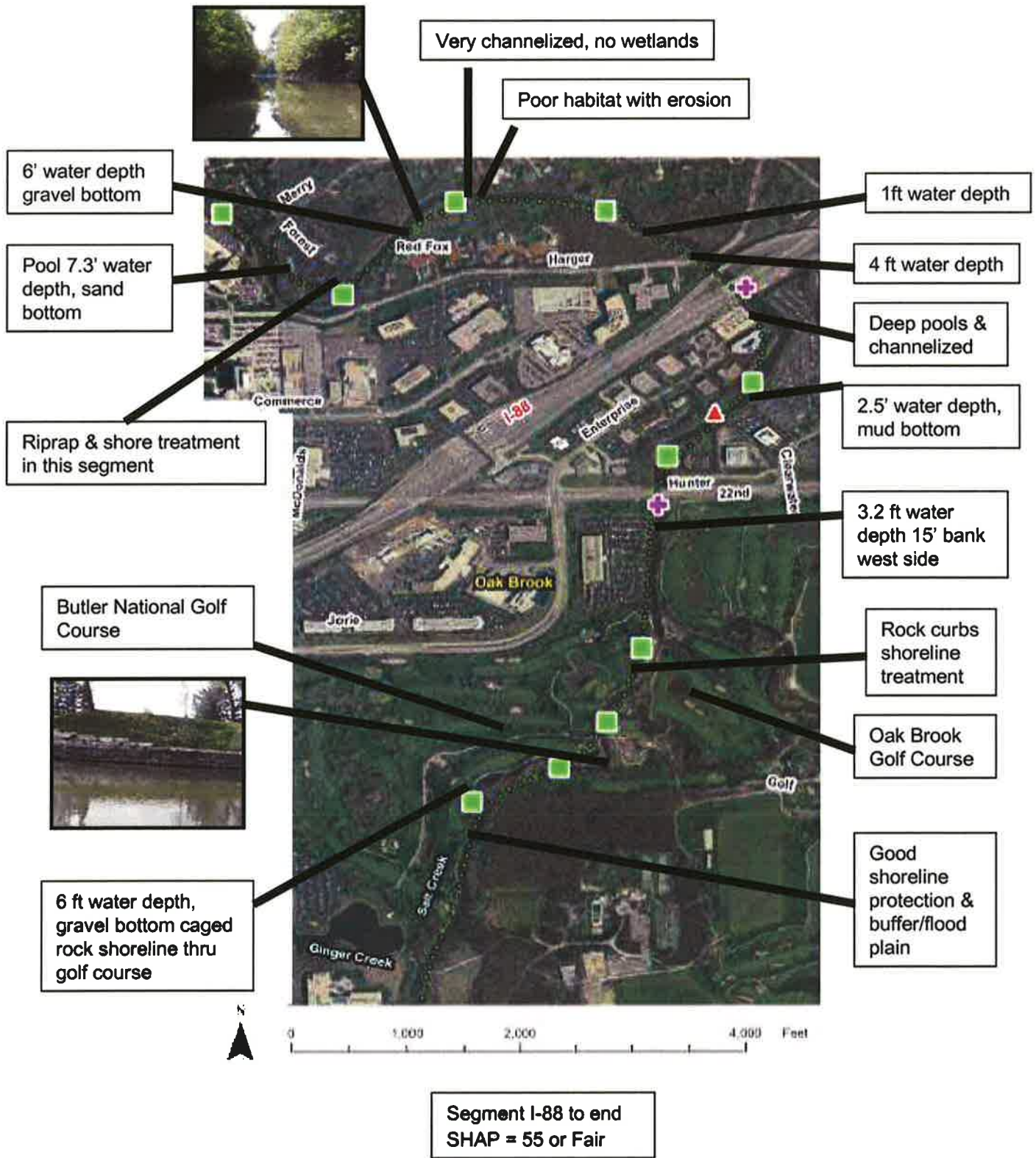
Segment 83 to Butterfield Road.  
SHAP = 78 or Fair

**FIGURE 2.4**  
**SALT CREEK**

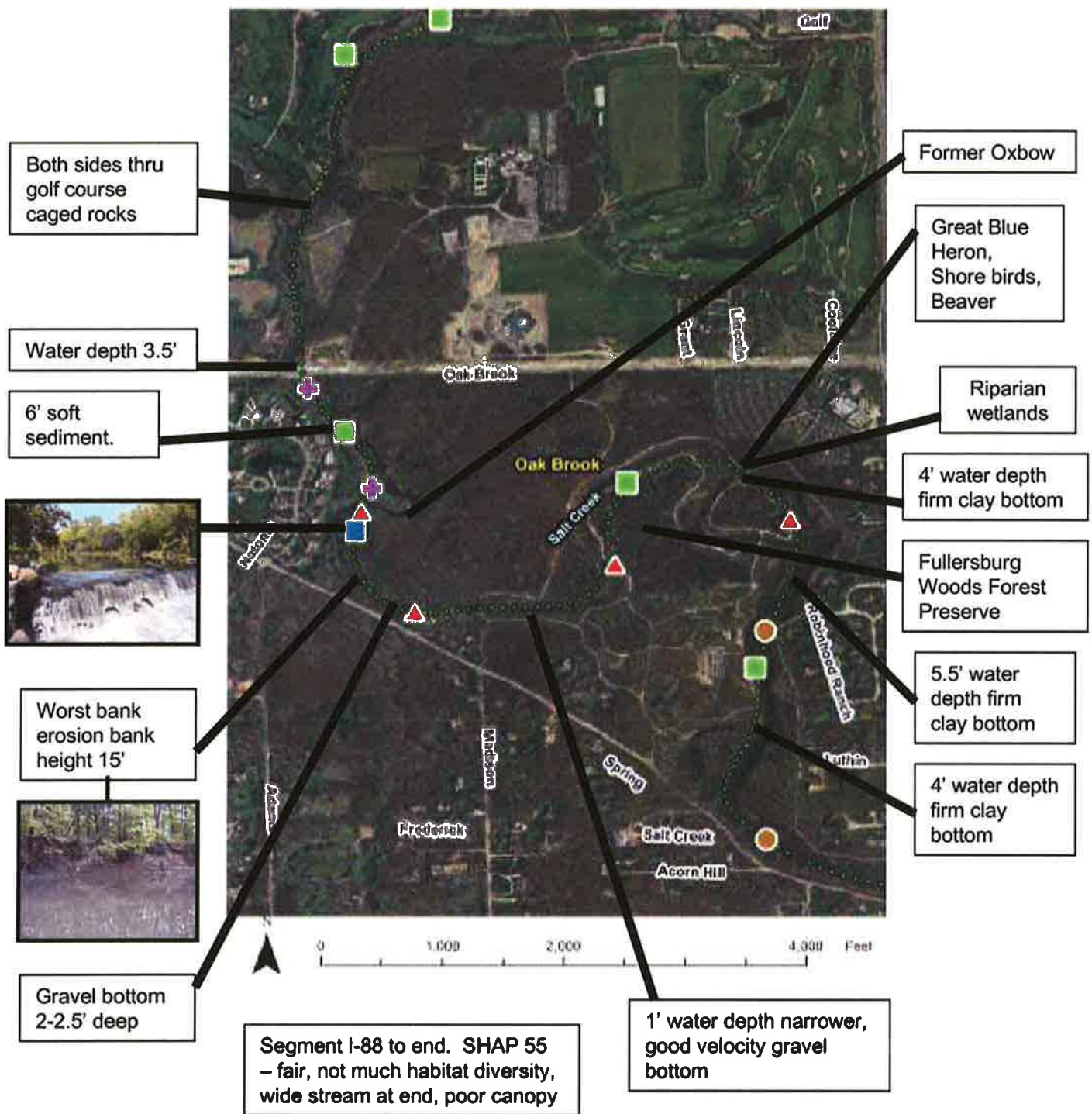




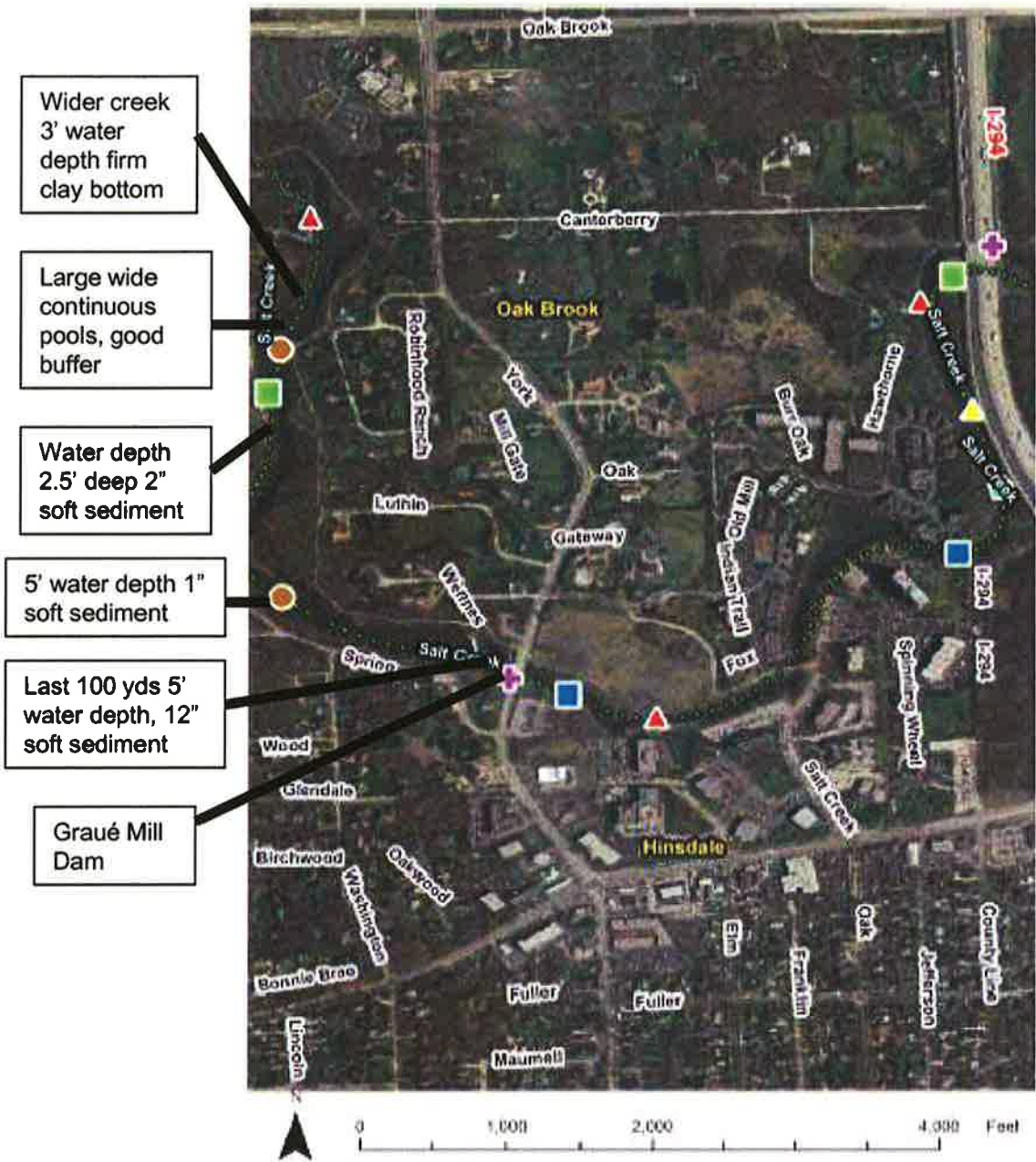
**FIGURE 2.5**  
**SALT CREEK**



**FIGURE 2.6**  
**SALT CREEK**



**FIGURE 2.7**  
**SALT CREEK**













**FIGURE 2.8**  
**SALT CREEK**

# EAST BRANCH DU PAGE RIVER FEATURES

DETERMINED FROM SPRING 2004 AERIAL VIDEO FLIGHTS

Note: Images are arranged from upstream to downstream.

## EXPLANATION

-  Break Point
-  Control Structure (bank)
-  Control Structure (bed)
-  Deposition
-  Log Jam
-  Point of Interest
-  Wetland
-  Bank Erosion
-  Outflow
-  East Branch DuPage River Flight Index



Churchill Woods Forest Preserve

Good riparian habitat



1. Silty sand  
1.5' - 2' water

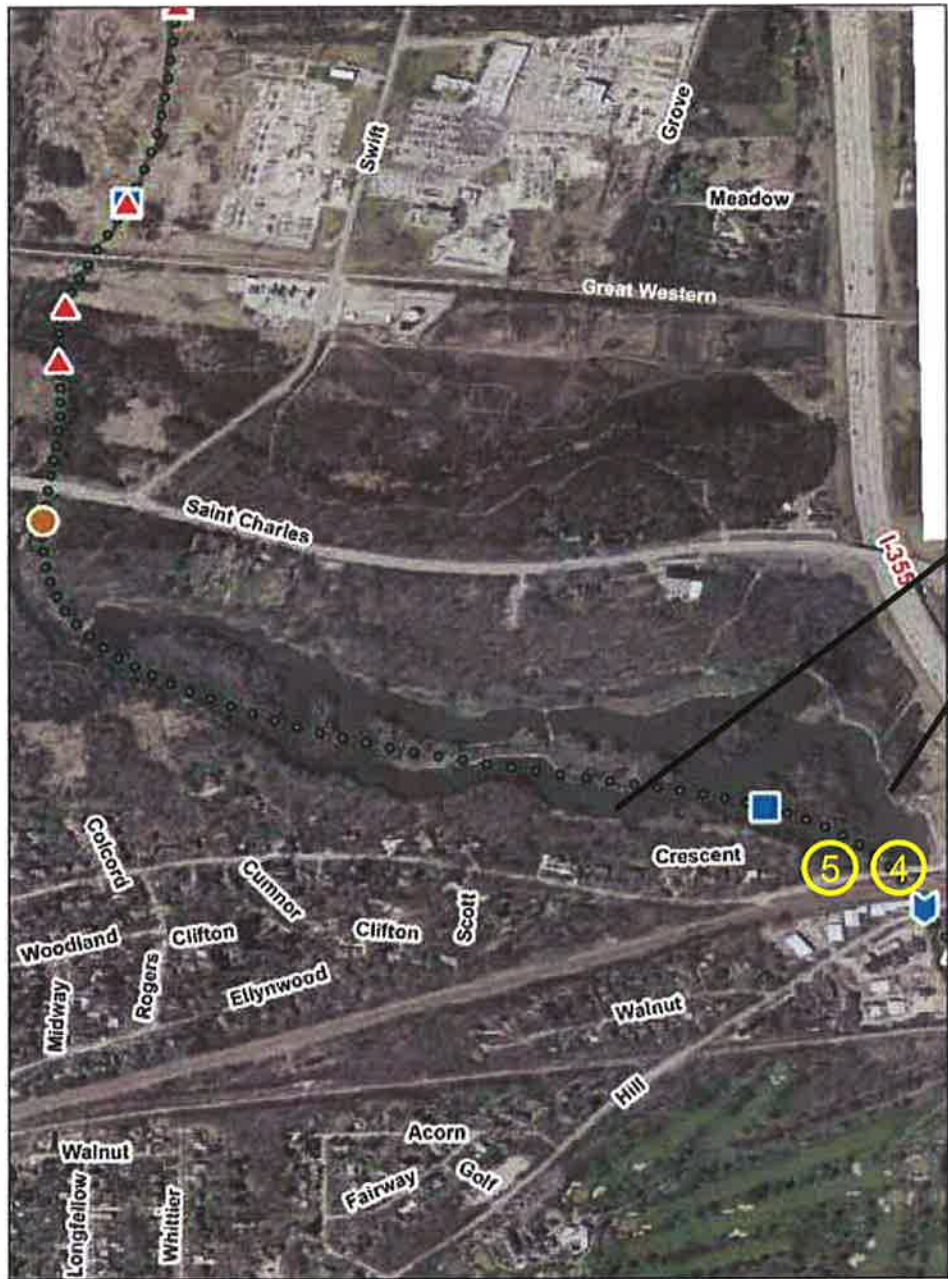


2. Mud/silt >2'  
1'-2' water



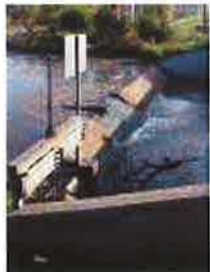
3. Shoreline stabilization >2'  
mud/silt 1'-2' water

East Branch Du Page River Features



Silt/Mud >2'

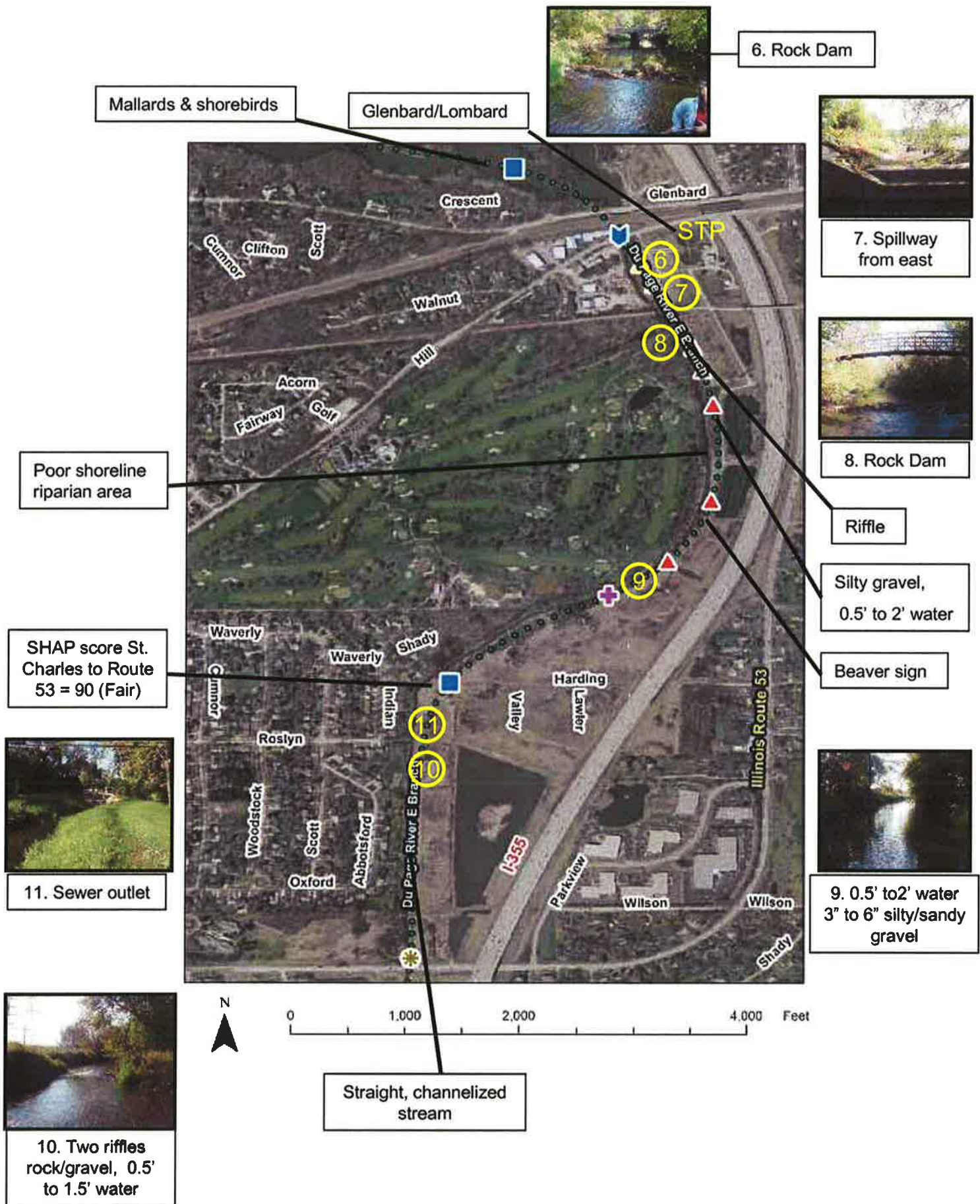
Bank stabilization



4. Spillway - 2' hydraulic head



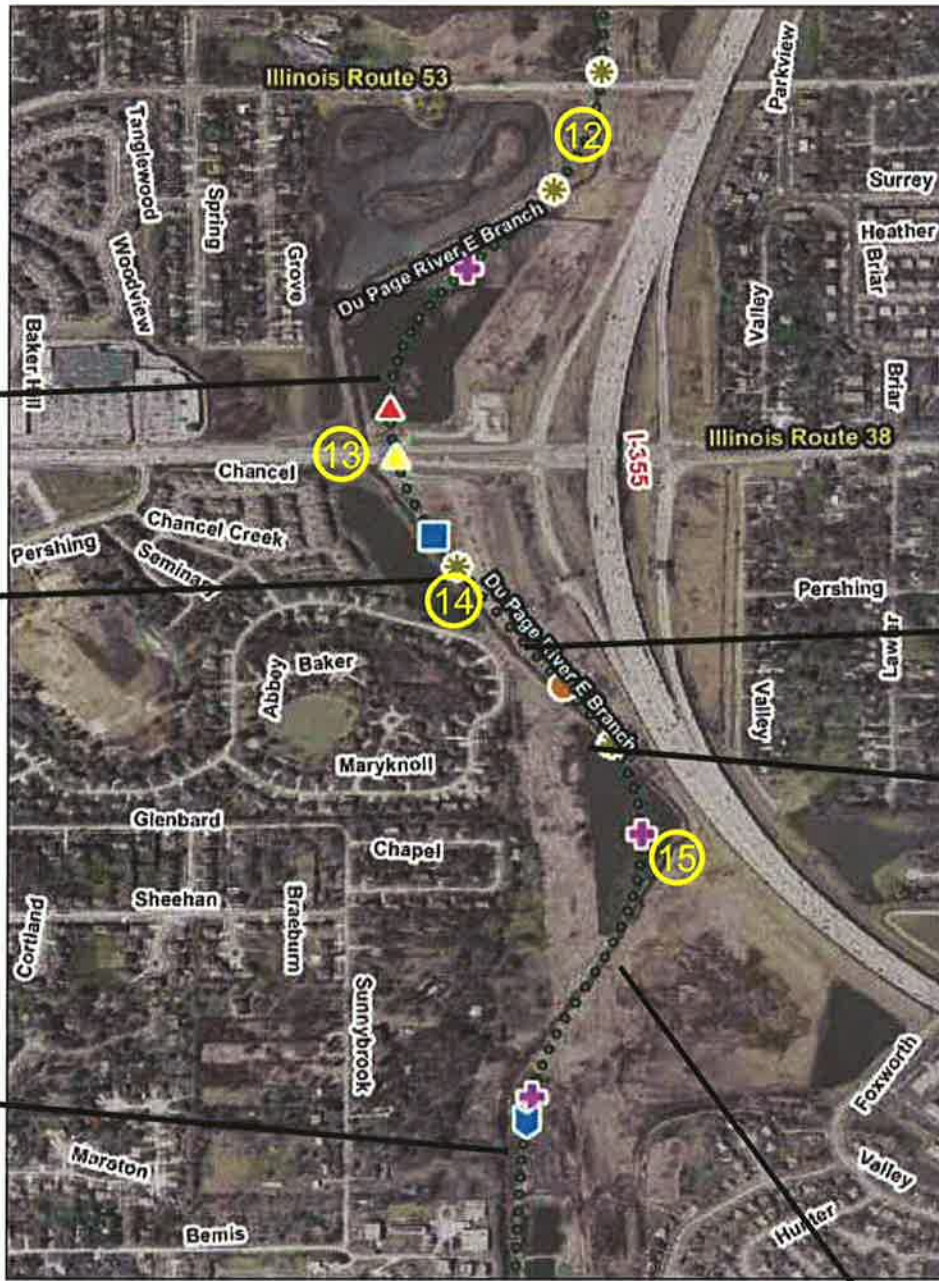
5. Silt/mud >2' deep - 3' to 4' water







12. Sandy gravel  
1.0' to 1.5' water



13. Log dam  
2' hydraulic head, 2'-3' water upstream, 3'-4' water downstream.

3.0 to 4.0' water  
6" to 18" sediment



14. 0' to 2' water  
gravel w/some silt

Old structure (dam) broken in middle

Riffle

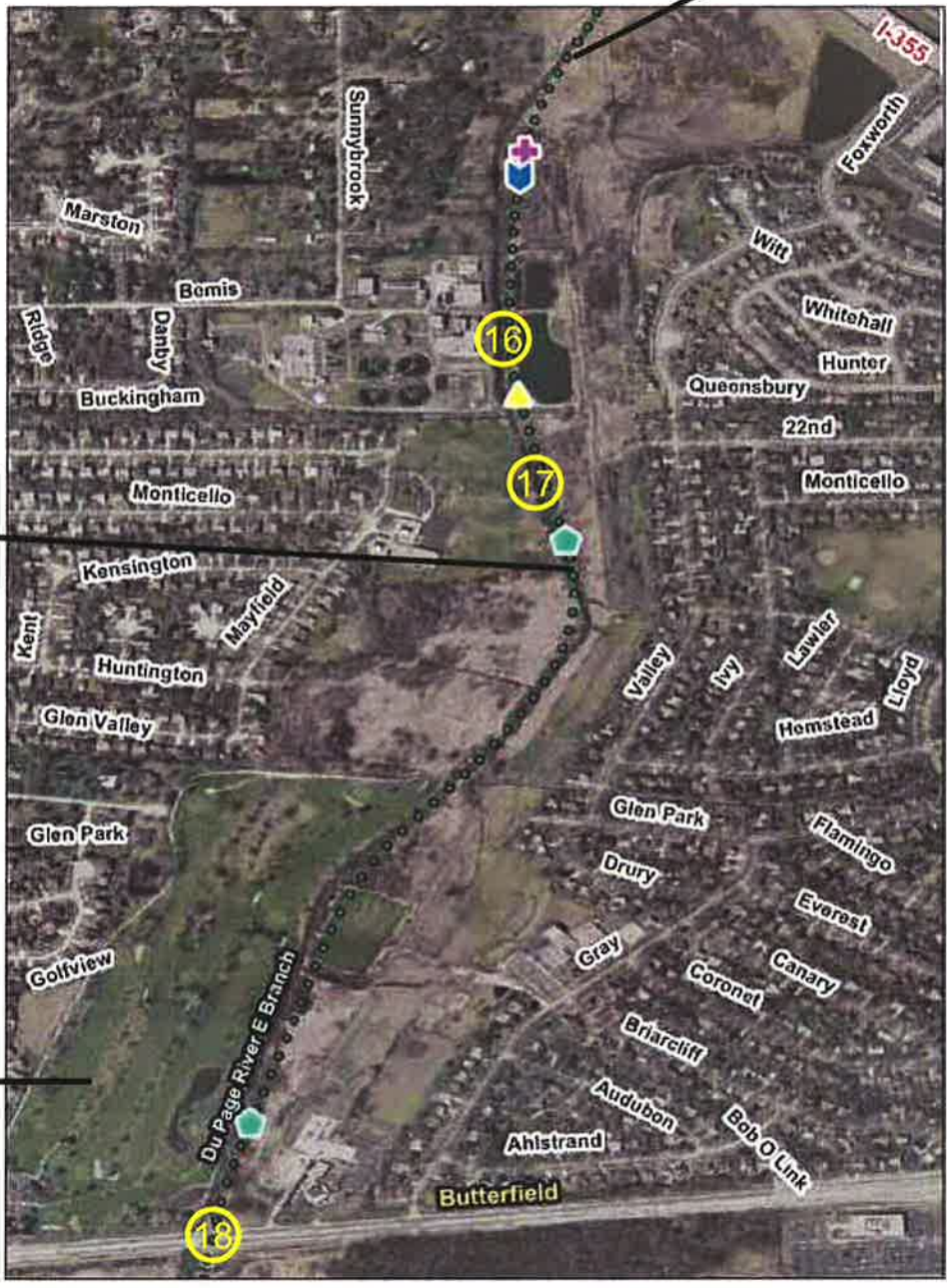


15. Stream flows into pond

Beaver, mallard & kingfisher in the section

2' water silt & sand some gravel, turns to gravel downstream

Poor canopy



IL Route 53 to Butterfield Section - SHAP Score = 89



16. Glenbard STP

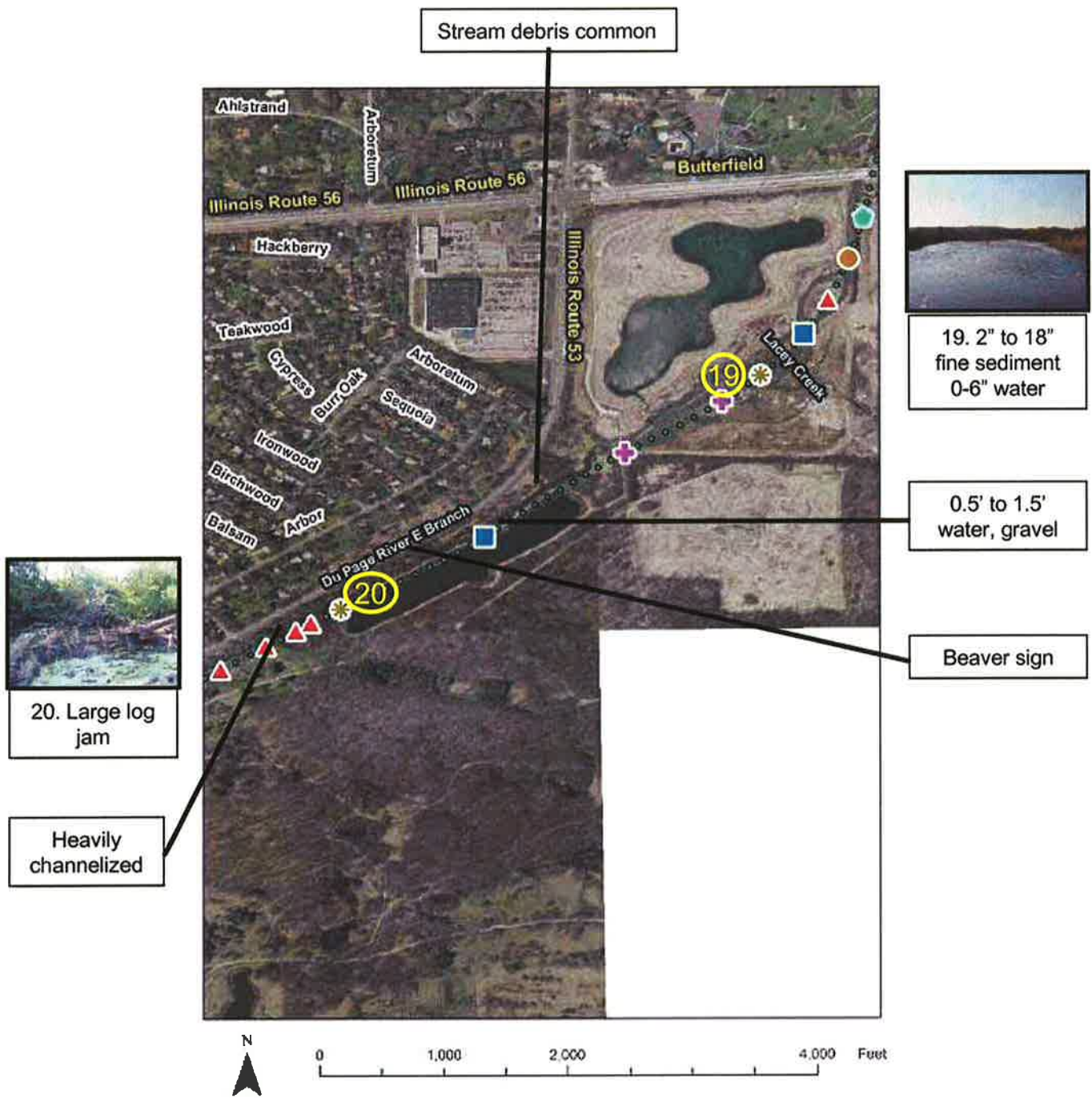


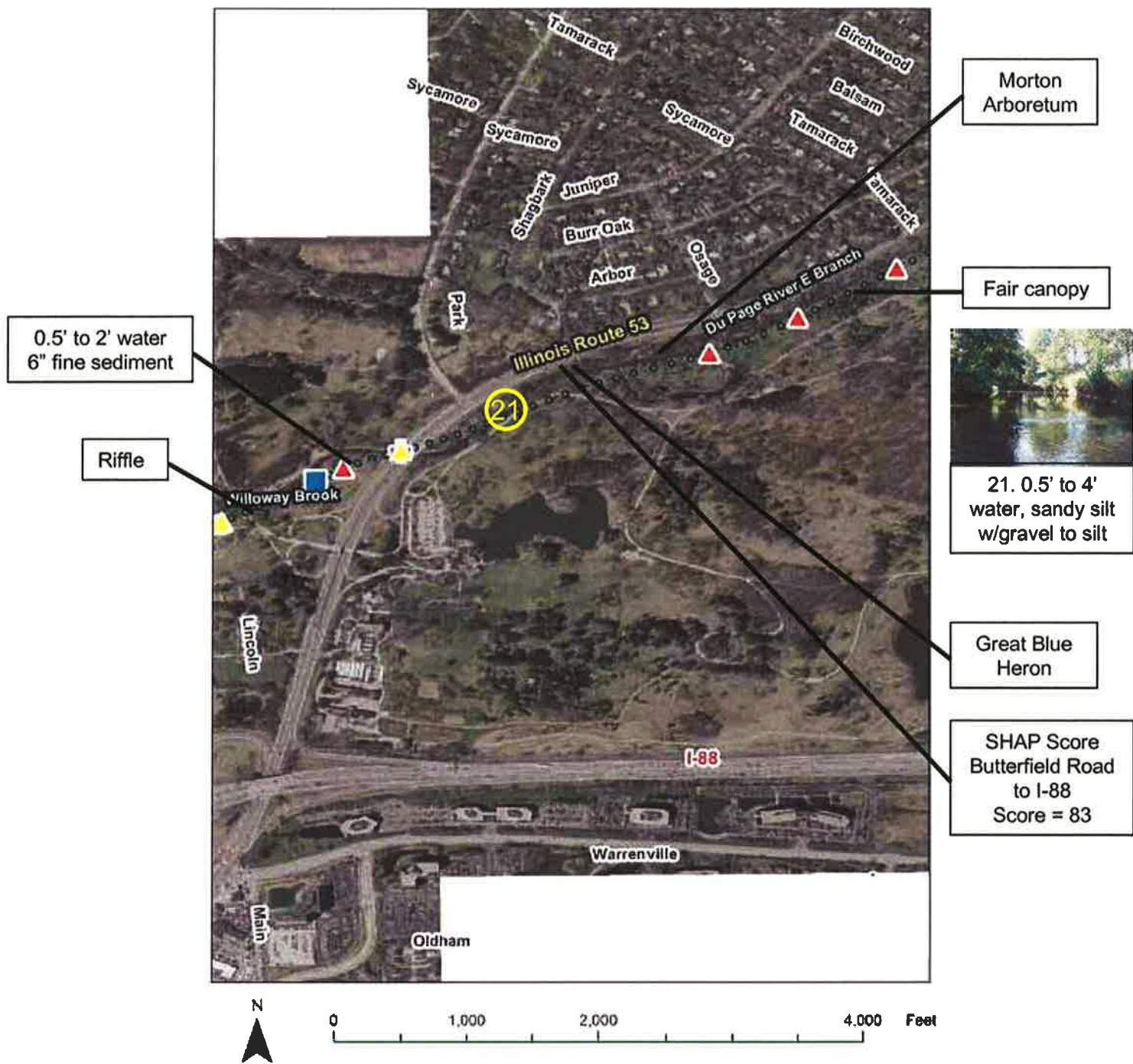
17. 1.5' to 2.5' water, silt & gravel turning to silt

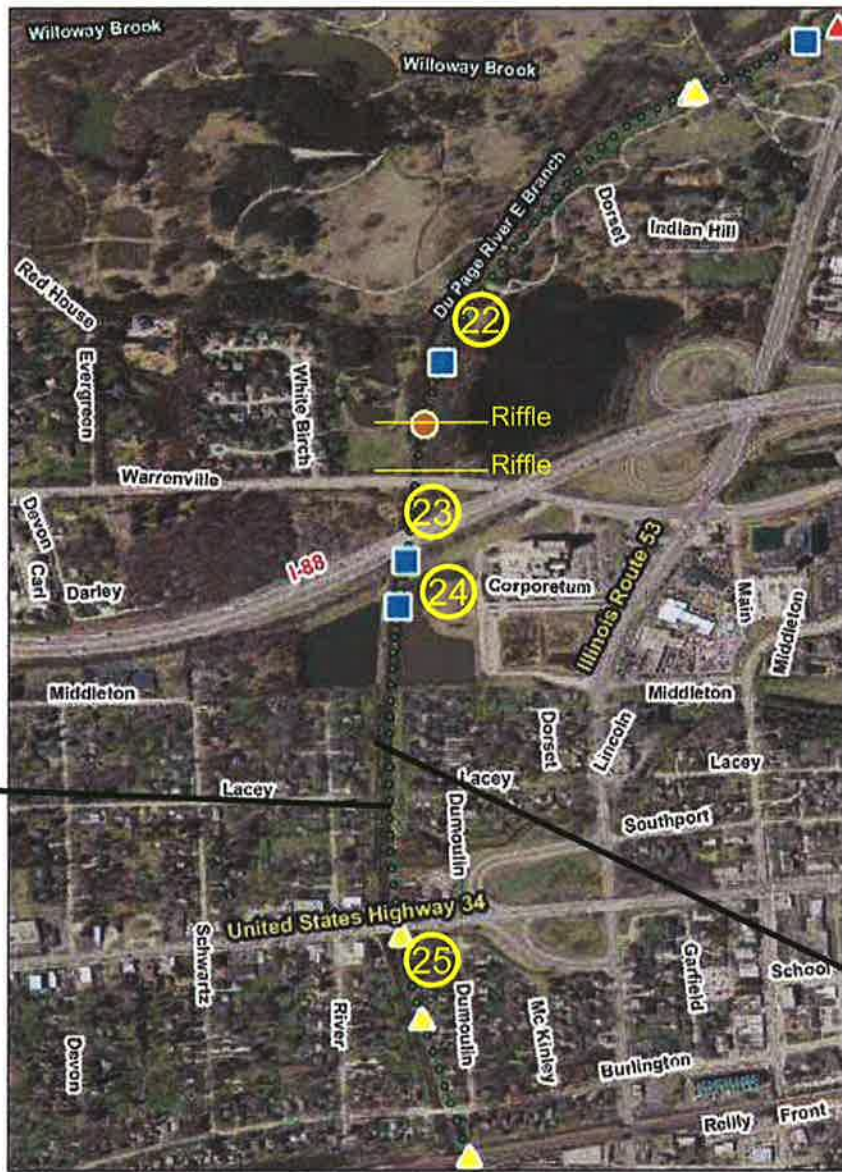
Western Springs Golf Course



18. Riffle at Butterfield, Before Butterfield - 0.5" to 2.5" water, gravel w/silt; After Butterfield - 1' to 2' water w/riffles, gravel







Residential with poor canopy & debris



22. Cobble Riffles



23. I-88 Overpass

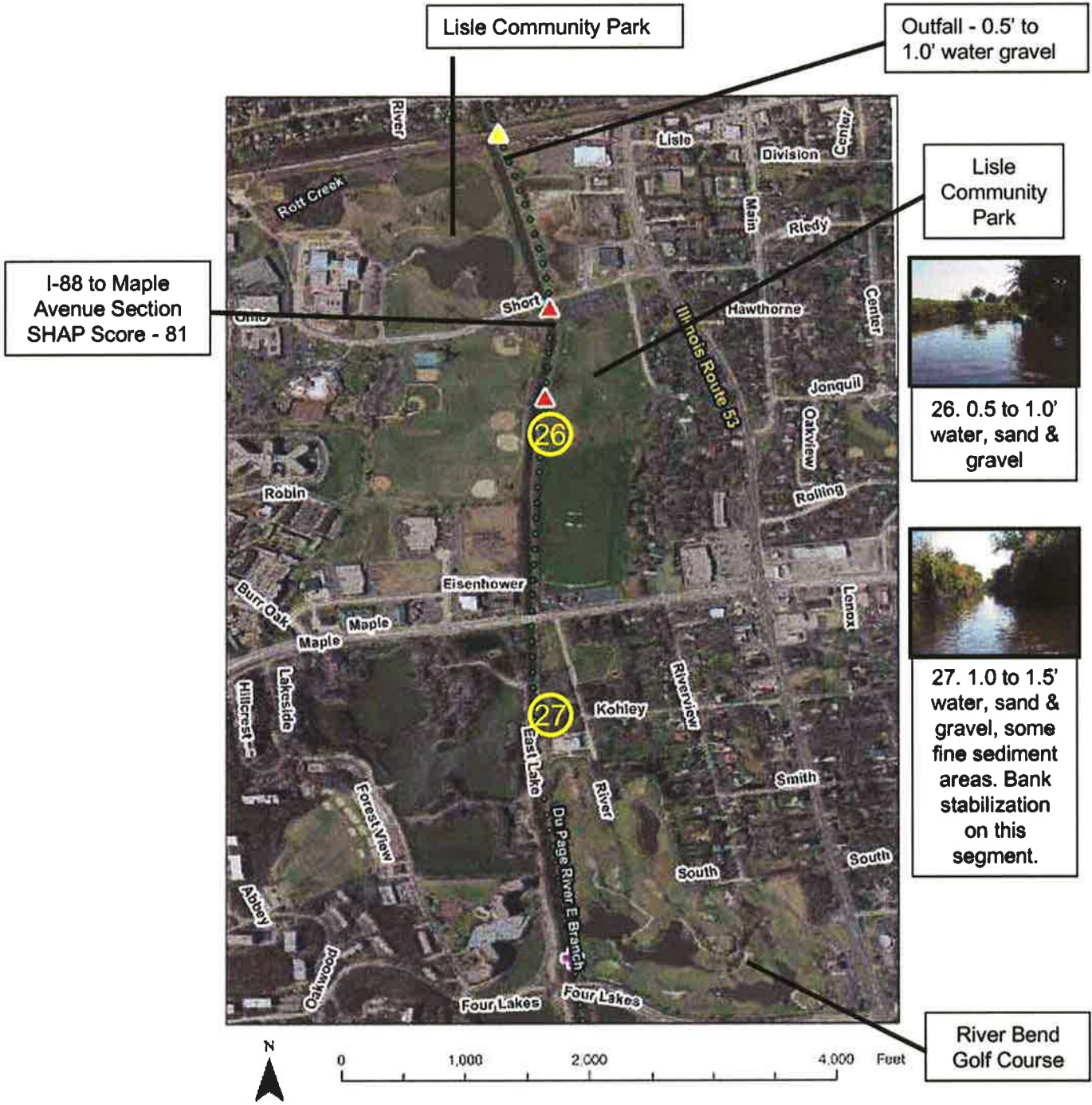


24. Rock dam 3' to 4' deep either side

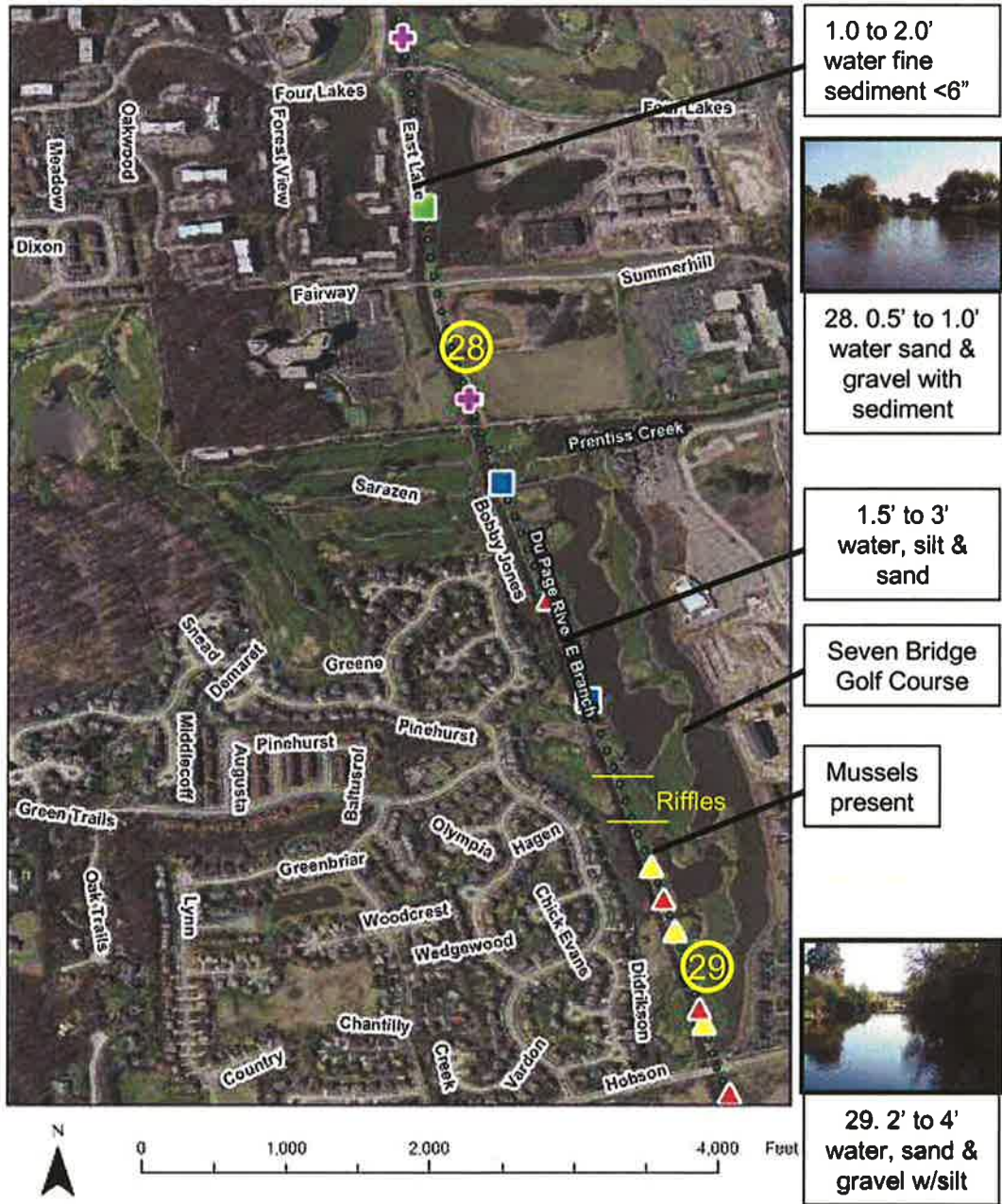
0.5 to 2' water, cobble/gravel



25. 0.5 to 1.0' water, gravel w/some fine sediment



Maple Avenue to  
Hobson Section  
SHAP Score - 89





30. Wide stretch, 0.5' to 3.0' water, gravel & fine sediment



32. 12" water, fine sediment & gravel

Green Valley Forest Preserve

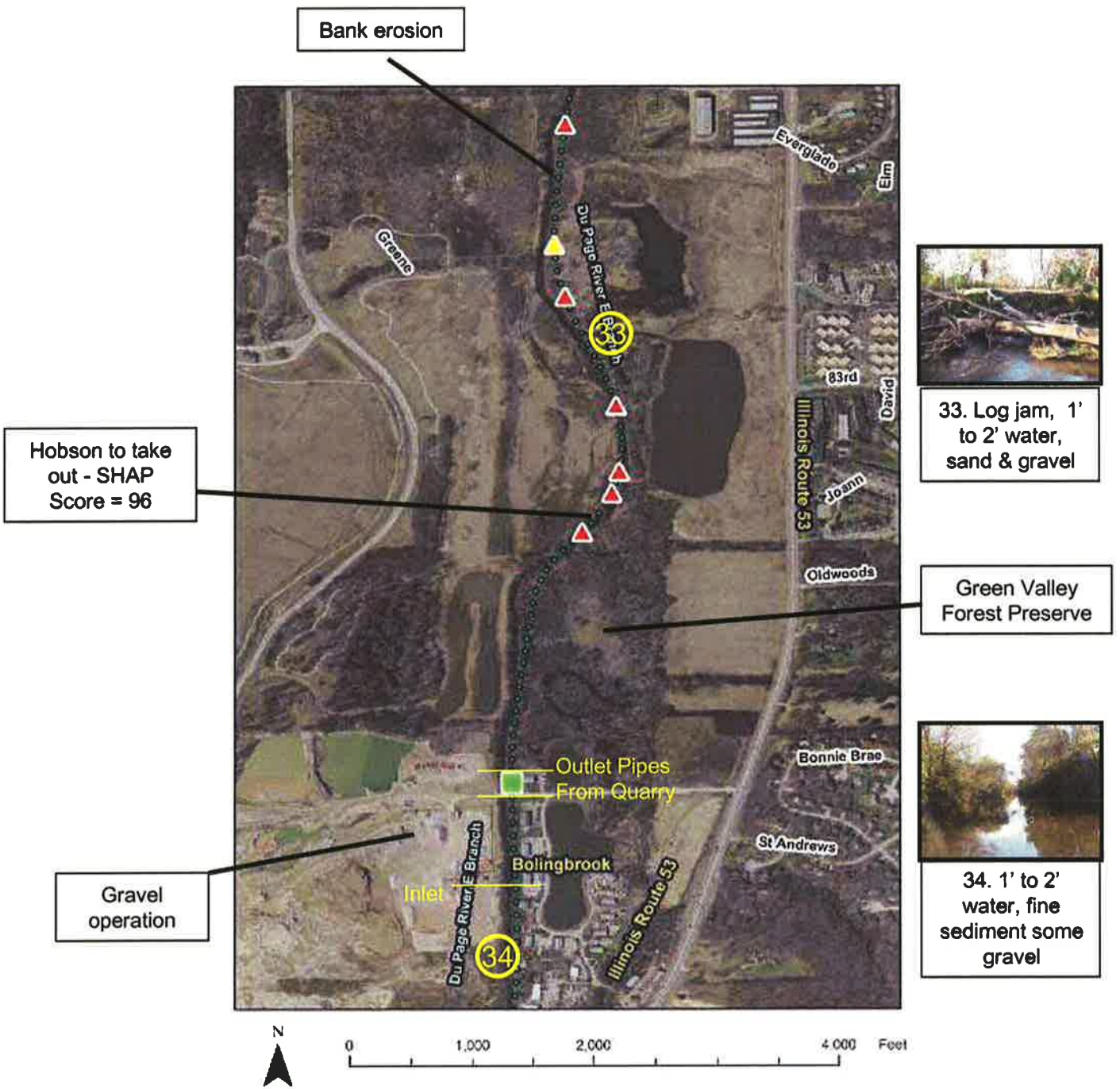


31. 3.0 to 4.0' water, sand & silt

0.5' to 1.5' water, garbage strewn

3.0' to 4.0' water, gravel







## Appendix B

**SALT CREEK / DUPAGE RIVER WORK GROUP**

**STREAM DISSOLVED OXYGEN IMPROVEMENT  
FEASIBILITY STUDY  
FOR  
SALT CREEK AND EAST BRANCH OF THE  
DUPAGE RIVER**

---



**FINAL DATA REPORT  
SOD MEASUREMENT SURVEY  
EAST BRANCH DUPAGE RIVER & SALT CREEK**

**NOVEMBER 20, 2006**

Prepared by:



HDR Engineering, Inc.  
8550 W. Bryn Mawr Ave.  
Suite 900  
Chicago, IL 606031  
Job No. 44054

In Association with:



## TABLE OF CONTENTS

1.0 OBJECTIVE.....1

2.0 METHOD.....1

    2.1 Quality Control .....2

3.0 SAMPLING STATIONS .....2

4.0 FIELD MEASUREMENTS.....2

5.0 DATA ANALYSIS .....3

6.0 CONCLUSIONS.....4

ATTACHMENT 1: MURPHY AND HICKS (1986)

ATTACHMENT 2: FIELD DATA SHEETS

## LIST OF TABLES

TABLE 1: SEDIMENT OXYGEN DEMAND (SOD) SURVEY LOCATIONS.....4

TABLE 2 TO TABLE 9: SOD MEASUREMENT STATION ID - EB1 TO EB8 .....4

TABLE 10 TO TABLE 17: SOD MEASUREMENT STATION ID - SC1 TO SC8.....4

TABLE 18: SUMMARY OF IN-SITU SOD .....4

## LIST OF FIGURES

FIGURE 1: IN-SITU SOD MEASUREMENT CHAMBER.....4

FIGURE 2: DEPLOYMENT OF SOD MEASUREMENT CHAMBERS .....4

FIGURE 3: SOD SURVEY LOCATIONS IN EB DUPAGE RIVER.....4

FIGURE 4: SOD SURVEY LOCATIONS IN SALT CREEK .....4

FIGURE 5 TO FIGURE 12: DO VS. TIME FOR SOD STATIONS EB1 TO EB8.....4

FIGURE 13 TO FIGURE 20: DO VS. TIME FOR SOD STATIONS SC1 TO SC8 .....4

## **1.0 Objective**

The purpose of this field survey was to collect data providing independent estimates of the sediment oxygen demand (SOD) in the East Branch DuPage River and Salt Creek that are being modeled for dissolved oxygen as part of the Stream Dissolved Oxygen Improvement Feasibility Study for Salt Creek and East Branch of the DuPage River. The field surveys were performed concurrently with the continuous DO monitoring coordinated by the Conservation Foundation. Selected steady-state DO monitoring data will be compared to the models as a validation check of QUAL2K simulations in Task 2 of the Feasibility Study. As water temperature affects SOD, it is advantageous to conduct the SOD survey during high temperatures that are appropriate for the modeling evaluations of alternatives, i.e., conditions assumed in the TMDL studies of these rivers (approximately 76 °F or 24.4 °C for Salt Creek)<sup>1</sup>.

## **2.0 Method**

The in-situ method, which by name means the measurements are made in the native location rather than in a laboratory, was employed (Murphy and Hicks 1986, refer to Attachment 1 of this report). SOD measurement chambers designed by EPA Region 4 were used in conjunction with circulating water pumps and DO probes as described in Murphy and Hicks 1986. See Figure 1 for a diagram of In-Situ SOD Measurement Chamber. Two SOD chambers were placed in contact with the bottom sediments to measure the total DO depletion rate. A “blank” chamber that is enclosed at the bottom was used to measure the DO depletion attributable to the water processes, which are the biochemical oxygen demand (BOD) exertion and biotic respiration. In general, the chambers, which are opaque, were not placed within the photic zone where photosynthesis occurred. Light and dark BOD bottles were also deployed as a backup to the “blank” chamber and to measure photosynthetic effects, if any. The SOD rate is then calculated using the following equation:

$$\text{SOD} = (V/A) * (b_1 - b_2) / 1000$$

where SOD = sediment oxygen demand rate (g/m<sup>2</sup>/day)

b<sub>1</sub> = rate of change of DO concentration in the SOD chamber (mg/L/d)

b<sub>2</sub> = rate of change of DO concentration in the “blank” chamber (mg/L/d)

V = volume of chamber (L)

A = area of chamber (m<sup>2</sup>)

The three chambers were transported by boat (see Figure 2) to the designated SOD station for deployment by the sampling crew. Water depth recorded at the stations varied between 1.4 ft and 2.7 ft. While the chamber was being lowered to the bottom, water and trapped air was vented from the open ports on the top of the chambers. Ambient bottom water was ultimately enclosed in the chambers for the SOD measurements. The enclosed chambers were left for a minimum of 15 minutes while any resuspended sediment settled to the bottom before the DO measurements

---

<sup>1</sup> Temperature of TMDL alternative conditions for East Branch DuPage River was not given in the TMDL Report. It will be assumed the same as that of Salt Creek.

began. DO and temperature in each of the three chambers were measured every ten minutes for duration of at least 1.5 hours. The DO meter/probes used with the SOD chambers were YSI models 550 and 550A.

## **2.1 Quality Control**

DO meters/probes were calibrated using the normal air calibration procedure. DO readings on the three DO meters/probes at each sampling station were checked by the field crew for agreement within 0.5 mg/L. In addition, the initial and final DO in the light and dark bottles were measured by Winkler titration and the DO probe used in the first chamber (referred to as Probe 1) for another check on the accuracy of the probe measurements.

## **3.0 Sampling Stations**

The bottom substrate composed of fine grained sediments (clay, silt and sand) are conducive to measuring SOD; coarse materials (gravel, cobbles and boulders) are not because it is difficult to seal the bottom of the chamber. High SOD rate is associated generally with a high organic content of the sediment. Slow moving reaches of the river are areas where fine-grained, organic sediments are likely to be found. The impoundments and pools formed by dams and other obstructions (e.g., debris) were identified by the reconnaissance survey (Task 1) and the helicopter fly-over DVD. Eight sampling stations were selected on each of the two waterways for in-situ SOD measurement. When the field crews arrived at each station, the river bottom was viewed or probed to estimate the percent bottom coverage of fine-grained sediment. The width and depth of the river were also measured and recorded. The fine-grained sediment area was identified as a suitable location for deployment of SOD measurement chambers. Sampling locations on East Branch DuPage River and Salt Creek are presented in Figures 3 and 4, respectively. Also, refer to Table 1 for descriptions of sampling locations and river miles.

## **4.0 Field Measurements**

As stated previously, elevated water temperature was preferred for these measurements to reduce the modeling uncertainty associated with applying a temperature adjustment coefficient based on the literature. In order to capture high water temperature, SOD measurements were conducted during the summer months. Field measurements were performed on eight days, when there was no precipitation on that day, and the preceding day, starting on July 31, 2006 and ending on September 1, 2006. On each day of the field survey, SOD was measured at two stations. Water temperature from all 16 surveys ranged from 21.5 °C to 34.4 °C with an average of 25.9 °C. Tables 2 through 17 present raw data taken by the field crew during the survey.

## **5.0 Data Analysis**

All data recorded in the field were key-entered into Excel for analysis and graphical presentation (The field data sheets are included as Attachment 2 to this report). DO in each of the two replicate chambers and one blank chamber were plotted against time and the data were analyzed by regression analysis to determine the “best-fit” linear equation. The measured data and the slopes are presented graphically for each set of measurements in Figures 5 through 20. Table 18 presents a summary of the calculated SOD of all 16 survey stations.

In general the time series of DO data follow linear trends and the regression analyses resulted in highly correlated sets of data with r-squared<sup>2</sup> values greater than 0.97. One exception is at Station EB8 (Figure 12), which shows an abrupt decrease in the DO of all three chambers between 10:45 AM and 11:10 AM. The light and dark bottle data do not show a change in DO similar to the drop from 6.0 to 3.0 mg/L found in the blank chamber. The exact cause of the disturbances in the chambers has not been determined; however, a malfunction of the power supply to the DO meters or fouling of the meter membranes is a possible explanation. Nevertheless, the data collected prior to 10:45 only at this station were used in the analyses of the DO uptake rates.

The measurements of DO in the light and dark bottles by the Winkler titration generally yielded lower DO than the probe measurements. Laboratory analysis of the reagent used in the field, following the field survey, found a difference in the normality that would effectively increase the Winkler DO by 20%. This explains part, but not all, of the differences. Water sampling and analyses of potential analytical interferences (nitrate, iron and total organic carbon) was performed but was not able to pinpoint the exact cause of the discrepancy. Because the light and dark bottle measurements are a backup to the blank chamber measurements and the blank chamber data were sufficient, there was no reason to rely on the Winkler DO data. Hence, the issue of the Winkler DO results was averted.

Differences between the two SOD measurements at a given station varied. Large differences may indicate that the sediment composition varies spatially at that station, whereas small differences indicate a relatively uniform sediment composition. An average of the two SOD measurements is reported in Table 18.

The conventional way of reporting SOD data is at a base water temperature of 20 °C. The Arrhenius temperature adjustment equation was used to convert SOD rates from the ambient temperature to 20 °C.

$$\begin{aligned} \text{SOD}(t) &= \text{SOD}(20) * \Theta^{(T-20)} \\ \Rightarrow \text{SOD}(20) &= \text{SOD}(t) / \Theta^{(T-20)} \end{aligned}$$

where SOD(t) = SOD at temperature T  
SOD(20) = SOD at 20 °C  
Θ = temperature correction coefficient

---

<sup>2</sup> r is defined statistically as the correlation coefficient; r-squared is simply r<sup>2</sup>.



A typical  $\Theta$  value for SOD is 1.08, which means there is an 8% change in SOD for a 1 °C change in temperature. Similarly, a 10 °C lower temperature (than 20 °C) yields an SOD rate that is 46% that of the base (20 °C) rate. Temperature adjusted to 20 °C for all stations are also found in Table 18.

## **6.0 Conclusions**

The SOD measured at ambient temperature in the East Branch (EB) ranged from a minimum of 0.67 g/m<sup>2</sup>/day to a maximum of 9.53 g/m<sup>2</sup>/day and similarly in Salt Creek (SC) ranged from a minimum of 0.09 g/m<sup>2</sup>/day to a maximum of 5.74 g/m<sup>2</sup>/day. The higher SOD in EB is in part attributable to the higher ambient temperature that occurred in EB as compared to SC. Station-averaged temperature-adjusted SOD in EB was in the range of 1.13 to 3.61 g/m<sup>2</sup>/day, as compared to the range of 0.47 to 3.59 g/m<sup>2</sup>/day in SC. This suggests that the SOD in EB is slightly greater than the SOD in SC. The 20 °C SOD rates used in the preliminary QUAL2K modeling of EB and SC were in the range from 1.0 to 2.5 g/m<sup>2</sup>/day.

The results of the SOD survey will be used to evaluate the SOD parameters in the QUAL2K model of East Branch DuPage River and Salt Creek. The modeled parameters will be adjusted based on the results of this field study.

**Table 1: SOD Survey Locations**

Station ID	Reach	River Miles	Location
EB1	East Branch DuPage River	19.9	Upstream of St. Charles Road
EB2	East Branch DuPage River	19.1	Churchill Woods Dam
EB3	East Branch DuPage River	18.9	Churchill Woods on East Branch @ Crescent Blvd
EB4	East Branch DuPage River	16.9	East Branch just north of Rt 38 (Roosevelt Rd)
EB5	East Branch DuPage River	16.3	RM 16.5 at outflow of detention pond (Downstream of IL Rte 38)
EB6	East Branch DuPage River	14.8	300 ft upstream (north) of Butterfield on East Branch (east side of stream)
EB7	East Branch DuPage River	14.7	50 ft south of Butterfield Rd on East Branch
EB8	East Branch DuPage River	8.8	East Branch at Hobson Rd
SC1	Salt Creek	21.0	Downstream of Addison S WWTP at Fullerton
SC2	Salt Creek	19.5	North Ave. at Salt Creek - immediately south of bridge in center of stream bed
SC3	Salt Creek	16.2	Salt Creek at Butterfield Rd. between two bridges along east bank.
SC4	Salt Creek	13.9	Upstream of Rt 22, Cermak
SC5	Salt Creek	12.5	Downstream of 31 St. above Old Oak Brook Dam
SC6	Salt Creek	11.1	Bridge at Fullersburg Woods (at monitoring site)
SC7	Salt Creek	10.8	Upstream of Graue Mill Dam
SC8	Salt Creek	7.9	Downstream of Wolf Road

**Table 2: SOD Measurement Station ID - EB1**

**Date:** 7/31/2006  
**Location:** Upstream of St. Charles Road  
**River:** Width 30 - 40 ft, Depth 18 inches, 50% Sediment, in shade, rocky bottom  
**Sediment:** 3 inches deep, grainy, small rock particles, fine silt, dark  
**Photosynthesis reference and QC:**

	Time		Probe Reading		Winkler Titration	
	Start	End	DO (mg/L)	Temp. (°C)	Titration Reading	DO (mg/L)
Initial	10:20 AM	-	5.41	26.0	239	4.78
Light bottle	10:10 AM	-	5.43	-	225	4.50
Dark bottle	10:10 AM	12:04	5.54	28.5	242	4.84
<b>Measurements:</b>						
Time	Probe 1		Probe 2		Blank	
	DO (mg/L)	Temp. (°C)	DO (mg/L)	Temp. (°C)	DO (mg/L)	Temp. (°C)
10:05 AM	4.73	25.3	4.02	25.6	5.31	25.3
10:11 AM	4.56	25.4	3.92	25.7	5.21	25.4
10:26 AM	4.39	25.5	3.82	25.9	5.21	25.5
10:36 AM	4.23	25.6	3.80	26.1	5.23	25.7
10:46 AM	4.05	25.8	3.72	26.2	5.25	25.9
10:56 AM	3.90	26.0	3.70	26.3	5.27	26.1
11:06 AM	3.75	26.1	3.65	26.6	5.29	26.2
11:18 AM	3.56	26.4	3.51	26.8	5.31	26.5
11:28 AM	3.41	26.6	3.39	27.0	5.32	26.7
11:38 AM	3.29	26.7	3.38	27.2	5.33	26.5
11:48 AM	3.13	26.9	3.29	27.3	5.35	27.0
11:58 AM	3.02	27.1	3.28	27.5	5.35	27.2

**Table 3: SOD Measurement Station ID - EB2**

**Date:** 7/31/2006  
**Location:** Churchill Woods Dam  
**River:** Very wide river above dam, 2.5 ft deep, shady area, 100% sediment.  
**Sediment:** 1.5 ft deep, fine, silty sediment, dark.

**Photosynthesis reference and QC:**

	Time		Probe Reading		Winkler Titration	
	Start	End	DO (mg/L)	Temp. (°C)	Titration Reading	DO (mg/L)
Initial	2:45 PM	-	12.13	32.6	571	11.42
Light bottle	2:45 PM	-	11.59	-	628	12.56
Dark bottle	2:45 PM	4:25 PM	11.84	-	526	10.52

**Measurements:**

Time	Probe 1		Probe 2		Blank	
	DO (mg/L)	Temp. (°C)	DO (mg/L)	Temp. (°C)	DO (mg/L)	Temp. (°C)
2:50 PM	11.13	32.5	10.63	32.4	11.71	33.2
3:00 PM	10.25	32.5	9.27	32.4	12.28	33.1
3:10 PM	9.85	32.4	8.92	32.4	12.18	33.0
3:20 PM	9.70	32.4	8.77	32.5	12.05	33.0
3:30 PM	9.36	32.4	8.49	32.6	11.92	33.1
3:40 PM	9.27	32.5	7.92	32.6	11.84	33.1
3:50 PM	8.95	32.5	7.61	32.8	11.71	33.1
4:00 PM	8.73	32.6	7.13	32.8	11.62	33.1
4:10 PM	8.67	32.6	7.04	32.8	11.60	33.1
4:20 PM	8.05	32.7	6.71	32.9	11.49	33.2

Note: 1) Probe 1: DO probe fell out during course of readings.  
 2) Probe 2: Air bubbles in tank  
 3) DO measurement at 2:50 PM for blank was considered to be an outlier and omitted in data regression.

**Table 4: SOD Measurement Station ID - EB3**

**Date:** 9/1/2006  
**Location:** Churchill Woods - East Branch @ Crescent Blvd  
**River:** width = wide, depth = 1.7'  
**Sediment:** depth = 1.1', description = thick, light fluffy on top of denser sediment

**Photosynthesis reference and QC:**

	Time		Probe Reading		Winkler Titration	
	Start	End	DO (mg/L)	Temp. (°C)	Titrator Reading	DO (mg/L)
Initial	3:06 PM	-	9.30	25.2	373	7.40
Light bottle	3:12 PM	4:56 PM	9.16	24.5	322	6.40
Dark bottle	3:12 PM	4:59 PM	7.85	24.8	393	7.80

**Measurements:**

Time	Probe 1		Probe 2		Blank	
	DO (mg/L)	Temp. (°C)	DO (mg/L)	Temp. (°C)	DO (mg/L)	Temp. (°C)
3:18 PM	7.62	24.2	7.37	25.3	8.50	24.4
3:28 PM	7.44	24.3	7.12	25.4	8.54	24.5
3:38 PM	7.26	24.4	6.83	25.5	8.47	24.5
3:48 PM	7.03	24.4	6.51	25.5	8.40	24.6
3:58 PM	6.91	24.4	6.35	25.4	8.33	24.5
4:08 PM	6.75	24.4	6.11	25.4	8.24	24.5
4:18 PM	6.62	24.4	5.90	25.3	8.17	24.5
4:28 PM	6.46	24.3	5.68	25.4	8.09	24.4
4:38 PM	6.35	24.3	5.44	25.3	8.01	24.4
4:48 PM	6.25	24.3	5.38	25.4	7.96	24.4

**Table 5: SOD Measurement Station ID - EB4**

**Date:** 8/1/2006  
**Location:** East Branch just north of Rt 38 (Roosevelt Rd)  
**River:** 30 to 40 ft wide, reasonably steep slope to 2 ft deep, 90% sediment cross-sectional coverage.  
**Sediment:** 12" sediment in center, 1" towards banks; very light; fine silt.

**Photosynthesis reference and QC:**

	Time		Probe Reading		Winkler Titration	
	Start	End	DO (mg/L)	Temp. (°C)	Titration Reading	DO (mg/L)
Initial	9:23 AM	-	5.77	29.8	158	3.16
Light bottle	9:33 AM	11:02	6.82	31.8	228	4.56
Dark bottle	9:33 AM	11:02	5.73	31.5	240	4.80

**Measurements:**

Time	Probe 1		Probe 2		Blank	
	DO (mg/L)	Temp. (°C)	DO (mg/L)	Temp. (°C)	DO (mg/L)	Temp. (°C)
9:30 AM	3.55	28.8	4.46	29.2	5.76	28.8
9:40 AM	3.34	29.1	4.16	29.5	5.16	29.1
9:50 AM	3.26	29.3	4.05	29.6	5.13	29.2
10:00 AM	3.15	29.5	3.84	29.8	5.12	29.4
10:10 AM	3.05	29.7	3.71	30.0	5.07	29.6
10:20 AM	2.93	29.9	3.54	30.2	5.07	29.8
10:30 AM	2.83	30.1	3.41	30.4	5.05	30.0
10:40 AM	2.70	30.4	3.21	30.7	5.03	30.3
10:50 AM	2.59	30.6	3.06	30.9	5.03	30.6
11:00 AM	2.51	30.8	2.92	31.1	5.01	30.8

Note: DO measurement at 9:30 AM for blank probe was considered to be erroneous and omitted in data regression.

**Table 6: SOD Measurement Station ID - EB5**

**Date:** 8/1/2006  
**Location:** RM 16.5 at outflow of detention pond (Downstream of IL Rte 38)  
**River:** Depth 1.7 ft in detention pond next to outflow, 100% coverage.  
**Sediment:** Depth 1.1 ft, very fine silty clay - very soft, chambers settled quite deeply.

**Photosynthesis reference and QC:**

	Time		Probe Reading		Winkler Titration	
	Start	End	DO (mg/L)	Temp. (°C)	Titration Reading	DO (mg/L)
Initial	-	-	9.21	34.5	397	7.94
Light bottle	2:05 PM	4:00 PM	9.19	33.9	267	5.34
Dark bottle	2:05 PM	4:00 PM	8.89	33.4	229	4.58

**Measurements:**

Time	Probe 1		Probe 2		Blank	
	DO (mg/L)	Temp. (°C)	DO (mg/L)	Temp. (°C)	DO (mg/L)	Temp. (°C)
2:10 PM	6.27	32.9	6.74	33.1	8.05	33.3
2:20 PM	5.56	33.1	5.87	33.1	7.89	33.4
2:30 PM	5.20	33.2	5.48	33.2	7.84	33.5
2:40 PM	4.75	33.3	5.05	33.3	7.78	33.7
2:50 PM	4.45	33.4	4.67	33.4	7.74	33.8
3:00 PM	4.18	33.5	4.44	33.5	7.59	33.9
3:10 PM	3.86	33.7	4.02	33.7	7.51	34.0
3:20 PM	3.67	33.9	3.70	33.8	7.44	34.2
3:30 PM	3.39	34.0	3.29	34.0	7.35	34.3
3:40 PM	3.17	34.0	3.24	34.0	7.29	34.4
3:50 PM	2.97	34.1	3.00	34.2	7.24	34.4

**Table 7: SOD Measurement Station ID - EB6**

**Date:** 8/2/2006

**Location:** 300 ft upstream (north) of Butterfield on East Branch (east side of stream).

**River:** 30 ft wide; 1.4 ft deep; 20% gravel, 30% sediment, coarse gravel, heavily undercut banks; east bank shaded (side in shade).

**Sediment:** Fine silt (not clay), 2" deep.

**Photosynthesis reference and QC:**

	Time		Probe Reading		Winkler Titration	
	Start	End	DO (mg/L)	Temp. (°C)	Titration Reading	DO (mg/L)
Initial	9:20 AM	-	5.53	26.1	212	4.24
Light bottle	9:25 AM	10:55	5.31	26.2	198	3.96
Dark bottle	9:25 AM	10:55	5.26	26.2	206	4.12

**Measurements:**

Time	Probe 1		Probe 2		Blank	
	DO (mg/L)	Temp. (°C)	DO (mg/L)	Temp. (°C)	DO (mg/L)	Temp. (°C)
9:25 AM	4.30	25.7	4.11	26.6	4.99	25.7
9:35 AM	4.16	25.7	4.04	26.6	4.92	25.7
9:45 AM	4.02	25.8	3.96	26.7	4.91	25.7
9:55 AM	3.93	25.8	3.91	26.6	4.91	25.8
10:05 AM	3.78	25.8	3.90	26.7	4.91	25.8
10:15 AM	3.75	25.8	3.89	26.7	4.91	25.8
10:25 AM	3.65	25.8	3.86	26.8	4.90	25.8
10:35 AM	3.59	25.9	3.82	26.8	4.89	25.9
10:45 AM	3.50	25.9	3.84	26.8	4.89	25.9
10:55 AM	3.45	25.9	3.86	26.8	4.88	25.9



**Table 8: SOD Measurement Station ID - EB7**

**Date:** 8/2/2006  
**Location:** 50 ft south of Butterfield Rd, East Branch.  
**River:** 40' wide, 1.4' deep, 2" of sediment, area dense with aquatic plants.  
**Sediment:** 2" deep, covers 100% of bottom, 50% gravel/sediment mix.

**Photosynthesis reference and QC:**

	Time		Probe Reading		Winkler Titration	
	Start	End	DO (mg/L)	Temp. (°C)	Titration Reading	DO (mg/L)
Initial	12:05 PM	-	7.32	28.1	298	5.96
Light bottle	12:05 PM	1:45 PM	7.76	28.0	216	4.32
Dark bottle	12:05 PM	1:45 PM	7.15	28.0	146	2.92

**Measurements:**

Time	Probe 1		Probe 2		Blank	
	DO (mg/L)	Temp. (°C)	DO (mg/L)	Temp. (°C)	DO (mg/L)	Temp. (°C)
12:04 PM	5.24	26.6	4.48	30.4	6.84	26.5
12:14 PM	4.83	26.6	4.64	27.4	6.83	26.5
12:24 PM	4.53	26.7	4.47	27.3	6.82	26.6
12:34 PM	4.41	26.8	4.30	27.4	6.81	26.7
12:44 PM	4.23	26.8	4.17	27.5	6.79	26.8
12:54 PM	4.02	26.9	3.91	27.4	6.79	26.8
1:04 PM	3.62	27.0	3.64	27.6	6.75	27.0
1:14 PM	3.43	27.1	3.51	27.7	6.74	27.0
1:24 PM	3.26	27.2	3.29	27.8	6.72	27.1
1:34 PM	3.14	28.0	3.13	28.0	6.71	27.2
1:44 PM	2.98	27.4	2.92	28.1	6.69	27.4

**Table 9: SOD Measurement Station ID - EB8**

**Date:** 8/8/2006  
**Location:** East Branch at Hobson Rd.  
**River:** Width 35 ft, gravel bed (subsurface sediment), 2 ft of water.  
**Sediment:** Fine black silty clay, 1.2 ft of sediment.

**Photosynthesis reference and QC:**

	Time		Probe Reading		Winkler Titration	
	Start	End	DO (mg/L)	Temp. (°C)	Titration Reading	DO (mg/L)
Initial	9:40 AM	-	6.96	22.9	-	6.50
Light bottle	9:45 AM	11:36	7.35	23.8	-	6.45
Dark bottle	9:45 AM	-	6.87	23.4	-	6.20

**Measurements:**

Time	Probe 1		Probe 2		Blank	
	DO (mg/L)	Temp. (°C)	DO (mg/L)	Temp. (°C)	DO (mg/L)	Temp. (°C)
9:42 AM	5.82	22.9	5.10	24.0	6.04	22.9
9:52 AM	5.75	23.0	5.00	24.0	6.14	23.0
10:02 AM	5.68	23.1	4.76	24.2	6.10	23.1
10:12 AM	5.51	23.2	4.67	24.2	6.08	23.1
10:22 AM	5.41	23.3	4.45	24.3	6.04	23.2
10:32 AM	5.40	23.4	4.26	24.4	6.01	23.3
10:42 AM	5.36	23.4	4.09	24.4	5.98	23.4
10:52 AM	4.40	23.5	2.32	24.5	5.14	23.4
11:02 AM	3.19	23.5	1.61	24.5	4.09	23.4
11:12 AM	2.94	23.6	1.71	24.5	3.38	23.5
11:22 AM	2.94	23.6	1.50	24.6	3.07	23.5
11:32 AM	2.85	23.7	1.65	24.6	3.02	23.6

Note: 1) 10:02 AM is Time 0 for Probe 1.  
 2) DO measurements from 10:52 AM to 11:32 AM were not used in data regression.

**Table 10: SOD Measurement Station ID - SC1**

**Date:** 8/21/2006  
**Location:** Downstream of Addison S WWTP at Fullerton  
**River:** Width 30 ft, depth 1.4 ft, 30% sediment on cross-section.  
**Sediment:** Depth 1.4 ft, silty sand, slightly clay, dark brown grey.

**Photosynthesis reference and QC:**

	Time		Probe Reading		Winkler Titration	
	Start	End	DO (mg/L)	Temp. (°C)	Titration Reading	DO (mg/L)
Initial	-	-	8.65	24.6	-	9.80
Light bottle	1:28 PM	3:10	8.71	24.5	-	-
Dark bottle	1:28 PM	3:10	8.48	24.3	-	6.00
<b>Measurements:</b>						
Time	Probe 1*		Probe 2		Blank	
	DO (mg/L)	Temp. (°C)	DO (mg/L)	Temp. (°C)	DO (mg/L)	Temp. (°C)
1:45 PM	4.14	23.6	7.08	24.5	8.04	23.7
1:55 PM	3.90	23.7	7.03	24.6	7.99	23.8
2:05 PM	3.75	23.8	6.94	24.7	7.94	23.9
2:15 PM	3.66	23.9	6.86	24.8	7.91	24.0
2:25 PM	3.58	24.0	6.79	25.0	7.87	24.1
2:35 PM	3.63	24.1	6.74	25.1	7.82	24.2
2:45 PM	3.71	24.1	6.62	25.1	7.79	24.2
2:55 PM	3.60	24.2	6.60	25.3	7.76	24.3
3:05 PM	3.50	24.3	6.53	25.3	7.72	24.4
3:15 PM	3.36	24.4	6.48	25.4	7.67	24.4

Note: \*Possible pump failure on #1

**Table 11: SOD Measurement Station ID - SC2**

**Date:** 8/21/2006  
**Location:** North Ave. at Salt Creek - immediately south of bridge in center of stream bed.  
**River:** Width 30 ft, depth 2 ft, 60% sediment on cross-section.  
**Sediment:** Depth: 0.4 ft; sandy gravel.

**Photosynthesis reference and QC:**

	Time		Probe Reading		Winkler Titration	
	Start	End	DO (mg/L)	Temp. (°C)	Titration Reading	DO (mg/L)
Initial	8:58 AM	-	6.99	21.6	-	7.20
Light bottle	9:05 AM	11:00	7.63	23.2	-	8.20
Dark bottle	9:05 AM	11:00	7.00	23.1	-	7.40

**Measurements:**

Time	Probe 1		Probe 2		Blank	
	DO (mg/L)	Temp. (°C)	DO (mg/L)	Temp. (°C)	DO (mg/L)	Temp. (°C)
9:05 AM	6.05	21.6	2.66	22.7	6.23	21.5
9:15 AM	6.18	21.6	2.43	22.7	6.48	21.6
9:25 AM	6.12	21.6	2.22	22.7	6.49	21.6
9:35 AM	6.08	21.7	2.07	22.7	6.45	21.6
9:45 AM	6.04	21.8	1.92	22.7	6.43	21.7
9:55 AM	5.98	21.8	1.93	22.8	6.40	21.7
10:05 AM	5.90	21.9	2.04	22.8	6.39	21.8
10:15 AM	5.87	22.0	2.10	22.8	6.38	21.9
10:25 AM	5.83	22.0	2.10	23.0	6.34	21.9
10:35 AM	5.80	22.1	2.05	23.1	6.35	22.0
10:45 AM	5.75	22.2	2.07	23.2	6.31	22.1

Note: DO measurements at 9:05 AM for all probes were considered erroneous and omitted in data regression.

**Table 12: SOD Measurement Station ID - SC3**

**Date:** 8/17/2006  
**Location:** Salt Creek at Butterfield Rd. between two bridges along east bank.  
**River:** 65 ft wide, 1.9 ft deep at probe, 50% sediment, 50% leaves, shells, weeds, organic material, small stones/rocks/pebbles.  
**Sediment:** 1.1 ft deep, fine black slightly clay-like upon squeezing dark brown.  
**Photosynthesis reference and QC:**

	Time		Probe Reading		Winkler Titration	
	Start	End	DO (mg/L)	Temp. (°C)	Titration Reading	DO (mg/L)
Initial	12:17 PM	-	8.39	24.3	-	6.40
Light bottle	12:21 PM	2:05 PM	8.10	25.4	-	7.00
Dark bottle	12:21 PM	2:07 PM	8.10	25.1	-	6.90
<b>Measurements:</b>						
Time	Probe 1		Probe 2		Blank	
	DO (mg/L)	Temp. (°C)	DO (mg/L)	Temp. (°C)	DO (mg/L)	Temp. (°C)
12:27 PM	7.15	24.1	6.24	24.5	7.95	24.0
12:37 PM	7.19	24.0	6.15	24.7	8.09	24.1
12:47 PM	7.02	24.1	6.08	24.8	8.09	24.1
12:57 PM	6.85	24.2	6.00	24.9	8.04	24.2
1:07 PM	6.71	24.3	5.88	25.0	8.02	24.3
1:17 PM	6.54	24.4	5.76	25.1	8.00	24.4
1:27 PM	6.39	24.5	5.75	25.3	7.96	24.5
1:37 PM	6.20	24.6	5.58	25.4	7.92	24.6
1:47 PM	6.06	24.7	5.53	25.5	7.90	24.6
1:57 PM	5.91	24.8	5.44	25.5	7.85	24.7

Note: DO measurements at 12:27 PM for all probes were considered erroneous and omitted in data regression.

**Table 13: SOD Measurement Station ID - SC4**

**Date:** 8/17/2006  
**Location:** Upstream of Rt 22, Cermak  
**River:** 35 ft wide, 1.4 ft deep, 100% sediment on cross-section.  
**Sediment:** Sediment depth=1.8 ft; organic matter present in fine black silt; non-clay (leaf litter).  
**Photosynthesis reference and QC:**

	Time		Probe Reading		Winkler Titration	
	Start	End	DO (mg/L)	Temp. (°C)	Titration Reading	DO (mg/L)
Initial	8:45 AM	-	5.96	22.1	-	5.00
Light bottle	8:55 AM	10:45	6.05	23.4	-	4.70
Dark bottle	8:55 AM	10:46	6.26	23.2	-	4.40
<b>Measurements:</b>						
Time	Probe 1		Probe 2		Blank	
	DO (mg/L)	Temp. (°C)	DO (mg/L)	Temp. (°C)	DO (mg/L)	Temp. (°C)
8:55 AM	4.36	22.3	4.30	23.5	5.38	22.2
9:05 AM	5.17	22.3	4.55	23.5	5.59	22.2
9:15 AM	5.10	22.4	4.43	23.6	5.57	22.3
9:25 AM	5.08	22.5	4.32	23.6	5.57	22.3
9:35 AM	5.04	22.5	4.23	23.7	5.57	22.3
9:45 AM	5.00	22.6	4.18	23.7	5.54	22.4
9:55 AM	4.98	22.7	4.13	23.8	5.53	22.5
10:05 AM	4.95	22.8	4.09	23.9	5.52	22.6
10:15 AM	4.90	22.8	3.96	24.0	5.49	22.6
10:25 AM	4.89	22.9	3.93	24.0	5.48	22.7
10:35 AM	4.85	23.0	3.85	24.1	5.45	22.7

Note: DO measurements at 8:55 AM for all probes were considered erroneous and omitted in data regression.

**Table 14: SOD Measurement Station ID - SC5**

**Date:** 8/16/2006  
**Location:** Downstream of 31 St. above Old Oak Brook Dam  
**River:** 100 ft wide, 2 ft deep; 30% soft silty non-clay, 70% clay pan type  
**Sediment:** Fine dark silt; non-clay, sediment depth=3ft.

**Photosynthesis reference and QC:**

	Time		Probe Reading		Winkler Titration	
	Start	End	DO (mg/L)	Temp. (°C)	Titration Reading	DO (mg/L)
Initial	2:04 PM	-	6.47	24.9	-	5.50
Light bottle	2:06 PM	3:25 PM	6.00	25.2	-	5.00
Dark bottle	2:06 PM	3:25 PM	6.24	24.5	-	4.90

**Measurements:**

Time	Probe 1		Probe 2		Blank	
	DO (mg/L)	Temp. (°C)	DO (mg/L)	Temp. (°C)	DO (mg/L)	Temp. (°C)
2:15 PM	5.12	24.3	4.28	24.7	6.28	24.3
2:25 PM	5.16	24.1	4.24	24.7	6.19	24.2
2:35 PM	5.02	23.9	4.13	24.6	6.16	24.1
2:45 PM	4.88	23.9	3.96	24.6	6.13	24.1
2:55 PM	4.82	23.8	3.86	24.6	6.09	24.1
3:05 PM	4.72	23.8	3.85	24.6	6.07	24.1
3:15 PM	4.59	23.8	3.70	24.6	6.02	24.1
3:25 PM	4.54	23.8	3.65	24.6	5.99	24.1
3:35 PM	4.49	23.8	3.54	24.5	5.97	24.0
3:45 PM	4.40	23.9	3.50	24.7	5.95	24.0

**Table 15: SOD Measurement Station ID - SC6**

**Date:** 8/16/2006  
**Location:** Bridge at Fullersburg Woods (at monitoring site)  
**River:** 80 ft wide and 1.6 ft deep at probe, 5 ft deep at center, 10% sediment on cross-section.  
**Sediment:** 0.2 ft deep sediment at probe; light, fluffy over rock.  
**Photosynthesis reference and QC:**

	Time		Probe Reading		Winkler Titration	
	Start	End	DO (mg/L)	Temp. (°C)	Titrator Reading	DO (mg/L)
Initial	9:10 AM	-	6.19	24.0	-	5.00
Light bottle	9:15 AM	11:04	6.09	24.7	-	5.40
Dark bottle	9:15 AM	11:06	6.13	24.4	-	5.20
<b>Measurements:</b>						
Time	Probe 1		Probe 2		Blank	
	DO (mg/L)	Temp. (°C)	DO (mg/L)	Temp. (°C)	DO (mg/L)	Temp. (°C)
9:10 AM	5.34	22.9	<del>5.08</del>	24.0	5.58	22.8
9:20 AM	5.37	23.1	<del>4.98</del>	24.1	5.91	22.9
9:30 AM	5.24	23.2	<del>5.28</del>	24.3	5.89	23.1
9:40 AM	5.14	23.3	4.91	24.3	5.88	23.2
9:50 AM	5.01	23.4	4.81	24.4	5.87	23.3
10:00 AM	4.84	23.5	4.71	24.5	5.86	23.4
10:10 AM	4.72	23.7	4.62	24.7	5.85	23.6
10:20 AM	4.61	23.8	4.49	24.8	5.83	23.7
10:30 AM	4.50	24.0	4.39	24.9	5.82	23.9
10:40 AM	4.39	24.1	4.30	25.0	5.80	24.1
10:50 AM	4.28	24.2	4.20	25.2	5.79	24.2
11:00 AM	-	-	4.08	25.3	-	-

Note: DO measurements at 9:10 AM for blank and Probe 1 were considered to be an outlier and omitted in data regression.



**Table 16: SOD Measurement Station ID - SC7**

**Date:** 8/8/2006  
**Location:** Upstream of Graue Mill Dam  
**River:** Impoundment behind dam, approx 100 ft at widest, 1.6 ft depth at #1, 2.6 ft depth at #2  
**Sediment:** 0.8 ft of sediment at #1 (stiffer clay-like sediment), 1.9 ft of sediment at #2 (light fluffy layer on top).  
**Photosynthesis reference and QC:**

	Time		Probe Reading		Winkler Titration	
	Start	End	DO (mg/L)	Temp. (°C)	Titration Reading	DO (mg/L)
Initial	3:14 PM	-	7.42	26.0	-	4.95
Light bottle	4:55 PM	5:00 PM	7.58	24.6	-	4.72
Dark bottle	4:55 PM	5:00 PM	6.02	25.3	-	3.64
<b>Measurements:</b>						
Time	Probe 1		Probe 2		Blank	
	DO (mg/L)	Temp. (°C)	DO (mg/L)	Temp. (°C)	DO (mg/L)	Temp. (°C)
3:19 PM	4.02	26.0	3.75	26.8	5.73	26.0
3:29 PM	3.98	26.0	4.04	26.9	6.74	26.0
3:39 PM	3.94	26.0	4.02	26.9	6.70	26.0
3:49 PM	3.81	26.0	3.84	26.9	6.80	26.0
3:59 PM	3.67	26.0	3.67	27.0	6.74	26.0
4:09 PM	3.56	26.1	3.55	27.0	6.70	26.1
4:19 PM	3.44	26.1	3.41	27.0	6.65	26.1
4:29 PM	3.41	26.1	3.31	27.0	6.62	26.1
4:39 PM	3.32	26.1	3.12	27.0	6.57	26.1
4:49 PM	3.20	26.1	2.97	27.0	6.53	26.1

Note: DO measurements at 3:19 PM for all probes were considered to be an outlier and omitted in data regression.

**Table 17: SOD Measurement Station ID - SC8**

**Date:** 9/1/2006  
**Location:** Downstream of Wolf Road  
**River:** 45' wide, 2.7' water depth  
**Sediment:** 0.7' sediment depth, description = coarse grained silt - no clay

**Photosynthesis reference and QC:**

	Time		Probe Reading		Winkler Titration	
	Start	End	DO (mg/L)	Temp. (°C)	Titration Reading	DO (mg/L)
Initial	10:40 AM	-	7.58	21.4	-	6.90
Light bottle	10:50 AM	12:30 PM	7.20	22.2	-	6.90
Dark bottle	10:50 AM	12:32 PM	7.28	22.0	-	6.60

**Measurements:**

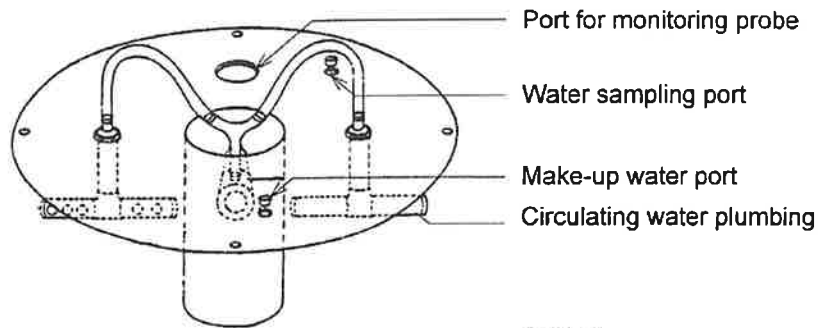
Time	Probe 1		Probe 2		Blank	
	DO (mg/L)	Temp. (°C)	DO (mg/L)	Temp. (°C)	DO (mg/L)	Temp. (°C)
10:50 AM	6.40	21.8	6.66	21.8	6.60	23.0
11:00 AM	6.35	21.8	6.43	21.8	6.64	23.0
11:10 AM	6.21	21.8	6.25	21.8	6.63	23.0
11:20 AM	6.09	21.9	6.04	21.8	6.60	23.0
11:30 AM	5.97	21.9	5.84	21.9	6.57	23.1
11:40 AM	5.88	21.9	5.68	21.9	6.53	23.1
11:50 AM	5.81	22.0	5.48	21.9	6.54	23.2
12:00 PM	5.74	22.0	5.32	22.0	6.50	23.2
12:10 PM	5.65	22.1	5.15	22.0	6.49	23.3
12:20 PM	5.59	22.1	4.98	22.1	6.46	23.3

**Table 18: Summary of In-Situ Sediment Oxygen Demand (SOD)**

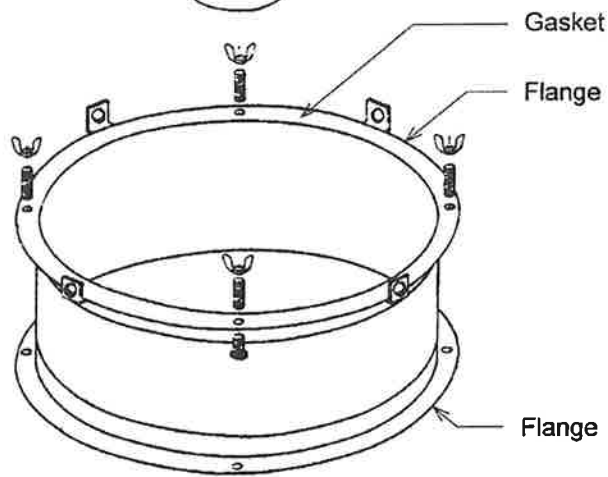
In-Situ SOD Measurement Chamber Dimensions: Volume (L) = 64.86; Area (m<sup>2</sup>) = 0.27

Station ID	Slope (mg/L/d)			SOD (g/m <sup>2</sup> /d)			Average Temperature (°C)		SOD (g/m <sup>2</sup> /d) - Temperature Corrected to 20 °C		
	Probe 1	Probe 2	Blank	Probe 1	Probe 2	Average	Probe 1	Probe 2	Probe 1	Probe 2	Average
EB1	-21.74	-9.46	1.55	5.59	2.64	4.12	26.1	26.5	3.49	1.60	2.55
EB2	-35.26	-48.10	-14.33	5.03	8.11	6.57	32.5	32.6	1.92	3.07	2.49
EB3	-22.12	-32.72	-9.82	2.95	5.50	4.23	24.3	25.4	2.12	3.63	2.87
EB4	-16.14	-23.76	-2.64	3.24	5.07	4.16	29.9	30.2	1.51	2.31	1.91
EB5	-44.82	-51.24	-11.56	7.99	9.53	8.76	33.6	33.6	2.82	3.35	3.08
EB6	-13.34	-3.94	-1.16	2.93	0.67	1.80	25.8	26.7	1.87	0.40	1.13
EB7	-31.99	-25.51	-2.24	7.15	5.59	6.37	27.0	27.9	4.17	3.05	3.61
EB8	-10.80	-24.79	-2.57	1.98	5.34	3.66	23.4	24.4	1.52	3.82	2.67
SC1	-9.05	-9.92	-5.70	0.80	1.01	0.91	24.0	25.0	0.59	0.69	0.64
SC2	-6.94	-3.17	-2.81	0.99	0.09	0.54	21.8	22.8	0.86	0.07	0.47
SC3	-23.09	-13.10	-4.39	4.49	2.09	3.29	24.4	25.1	3.21	1.42	2.31
SC4	-4.83	-10.53	-2.14	0.65	2.02	1.33	22.7	23.8	0.53	1.51	1.02
SC5	-12.69	-13.19	-4.98	1.85	1.97	1.91	23.9	24.6	1.37	1.38	1.38
SC6	-17.70	-14.88	-1.87	3.80	3.13	3.46	23.6	24.8	2.88	2.16	2.52
SC7	-14.42	-19.92	-4.03	2.50	3.82	3.16	26.1	27.0	1.57	2.23	1.90
SC8	-13.50	-26.68	-2.78	2.58	5.74	4.16	21.9	21.9	2.22	4.96	3.59

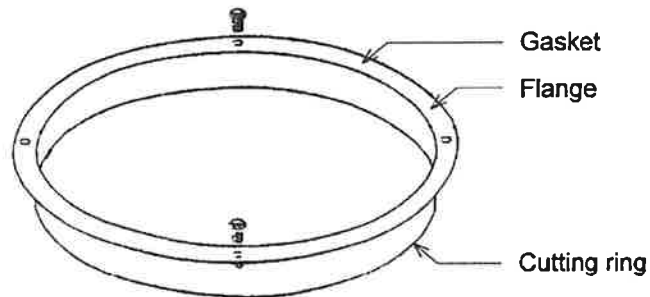
**LID**



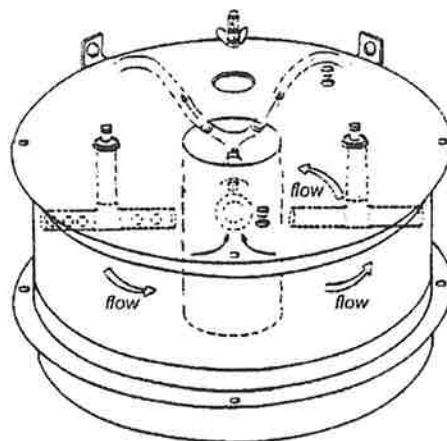
**BODY**



**FLANGE AND CUTTING EDGE**



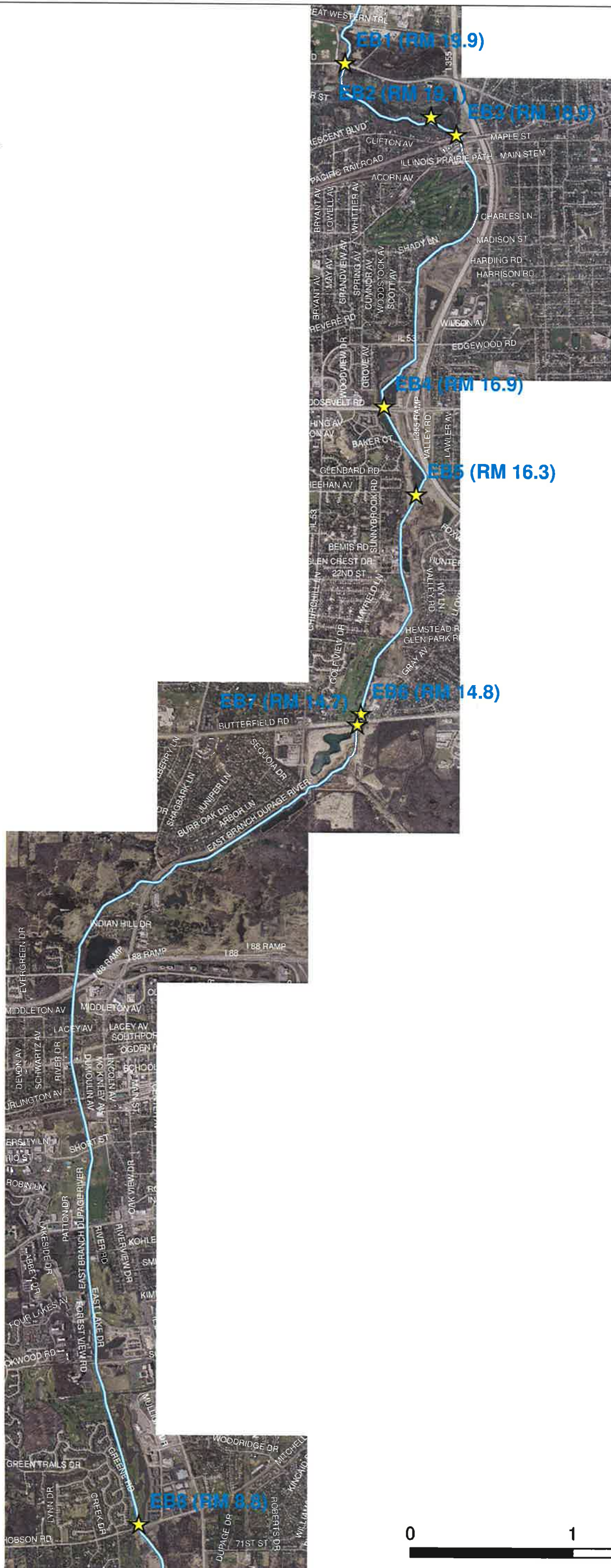
**ASSEMBLED CHAMBER**



**DIMENSIONS**

Area = 0.27 m<sup>2</sup>  
Volume = 64.86 L





**Legend**

★ SOD Sites

0 1 2 Miles

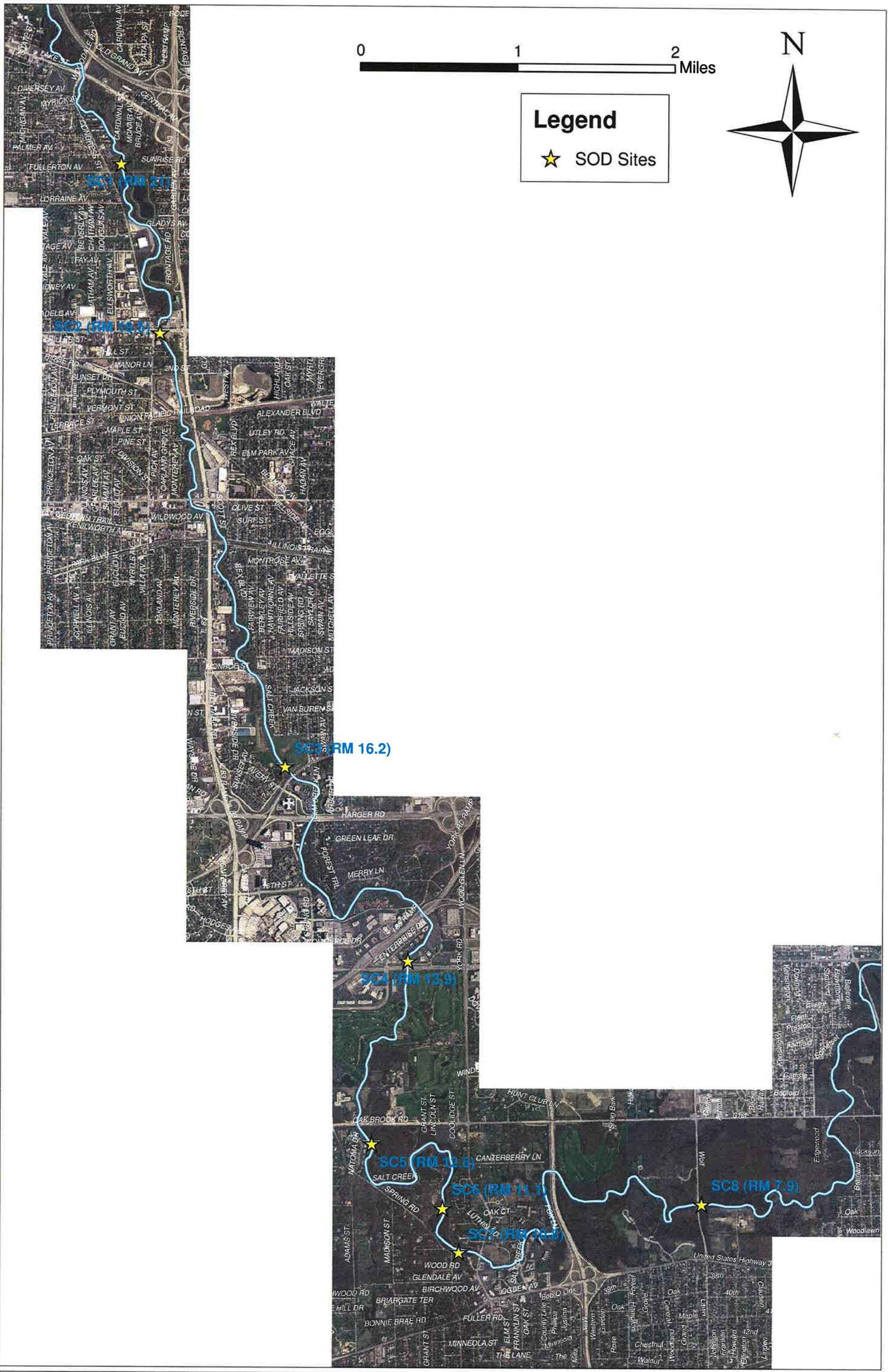


Figure 5: DO VS. Time  
In-Situ SOD Survey - Station EB1

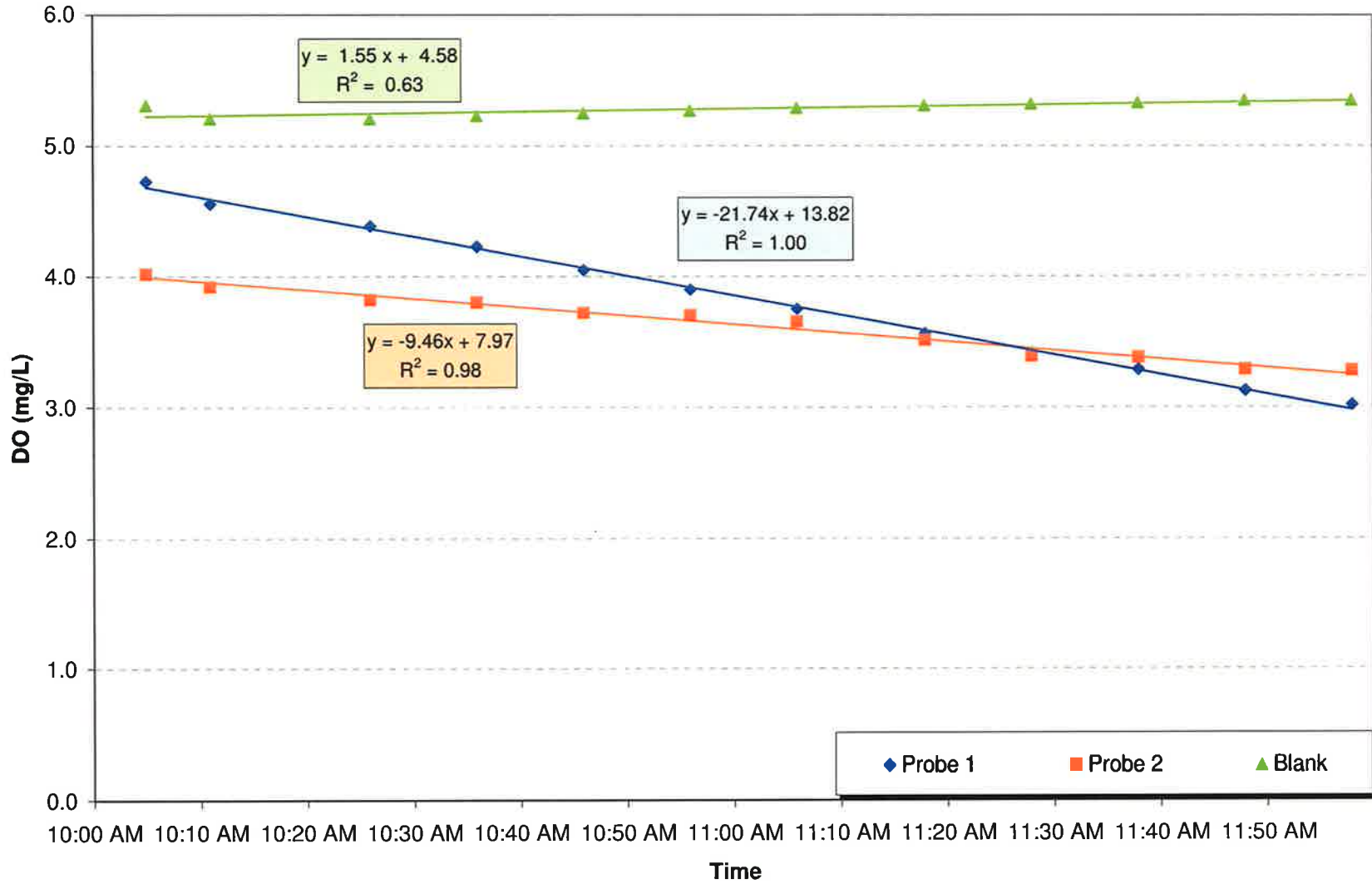




Figure 6: DO VS. Time  
In-Situ SOD Survey - Station EB2

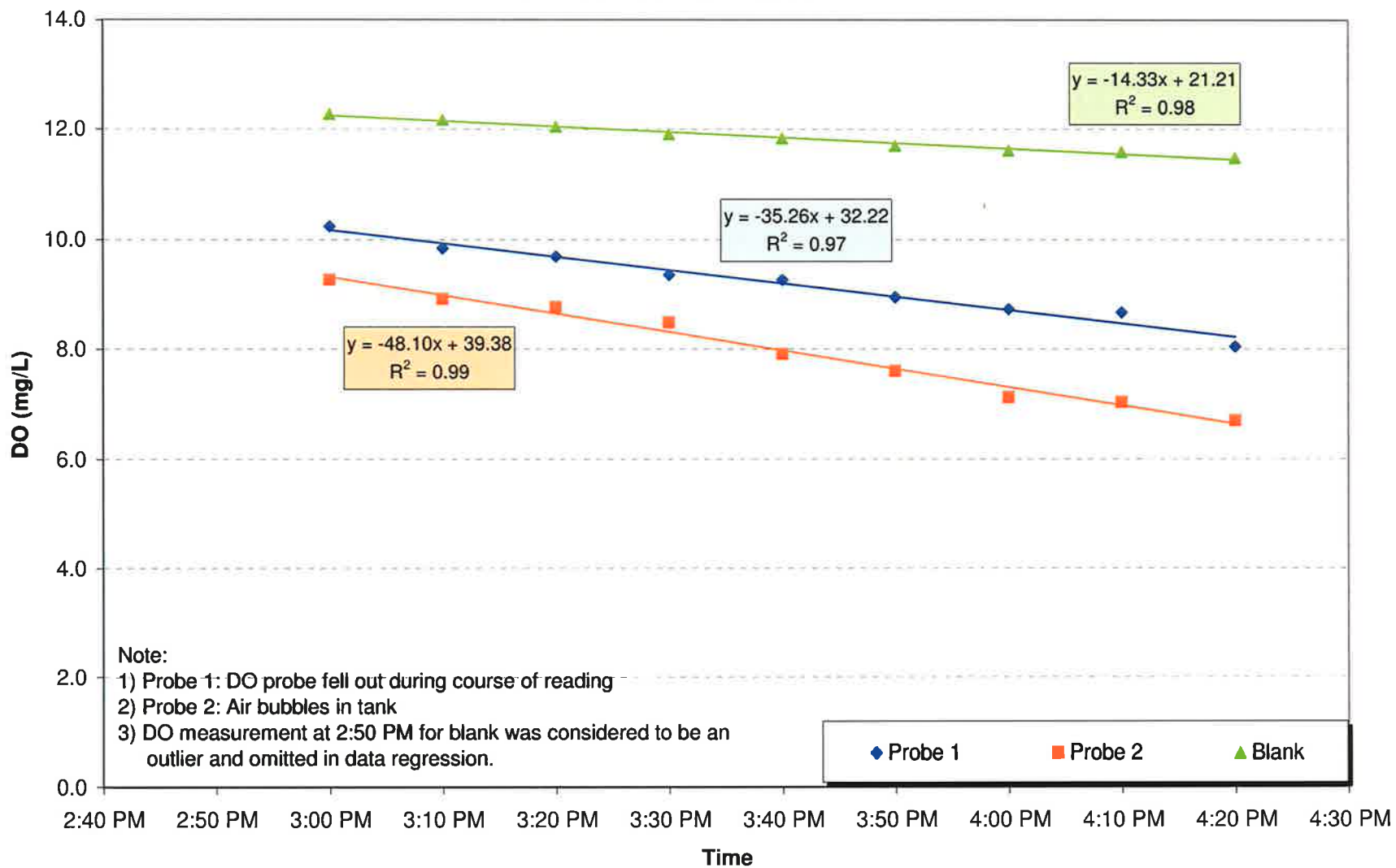


Figure 7: DO VS. Time  
In-Situ SOD Survey - Station EB3

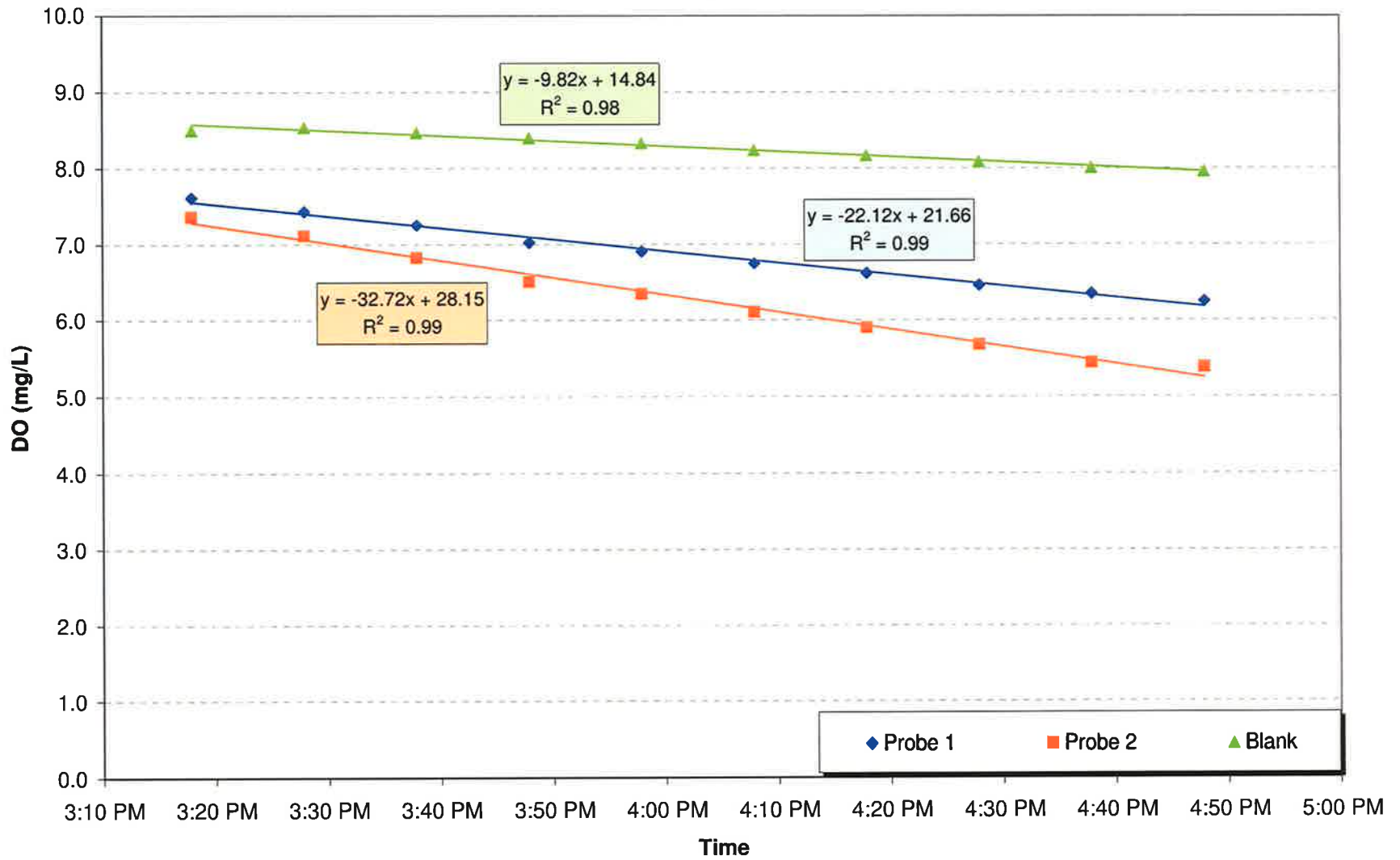


Figure 8: DO VS. Time  
In-Situ SOD Survey - Station EB4

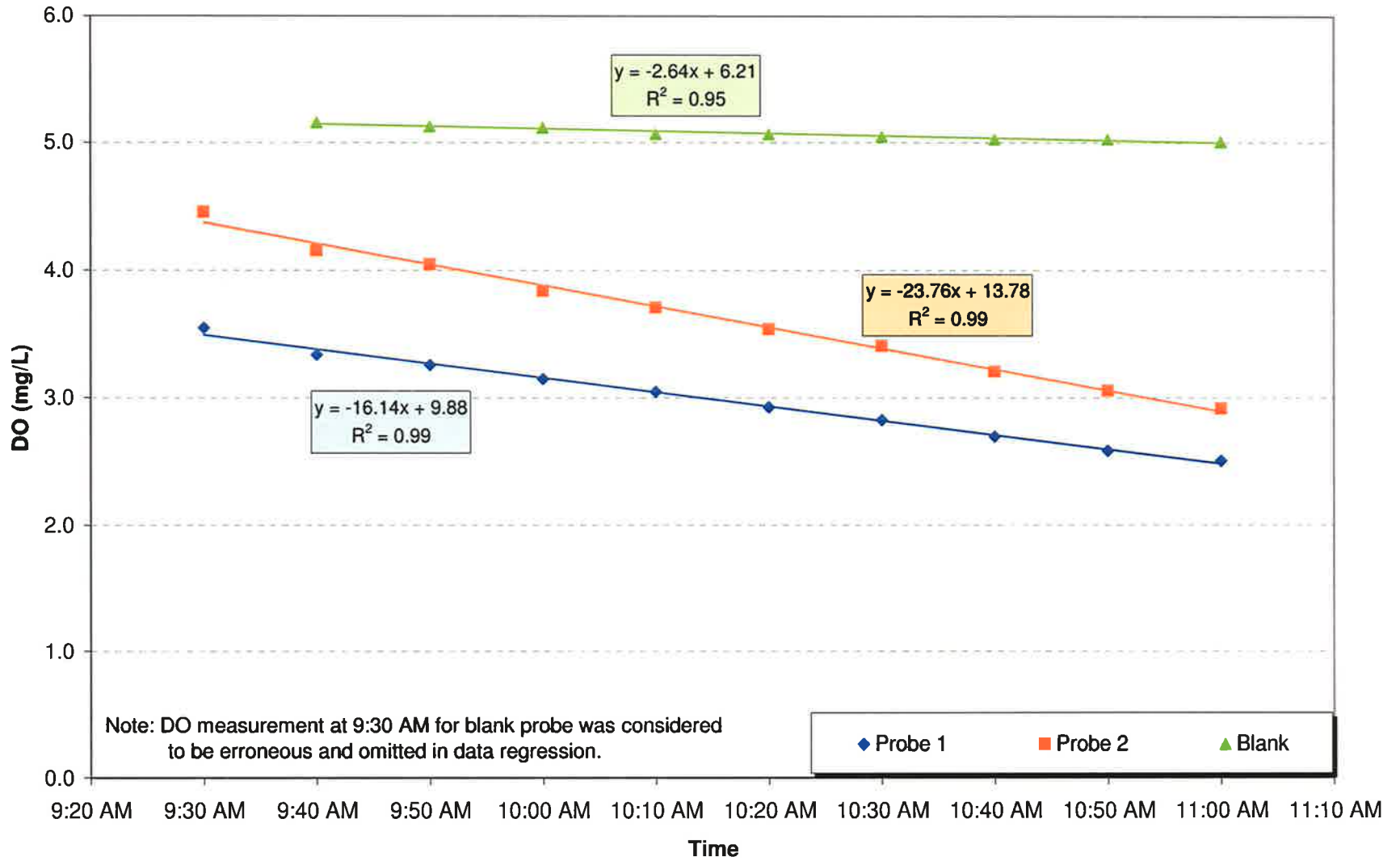


Figure 9: DO VS. Time  
In-Situ SOD Survey - Station EB5

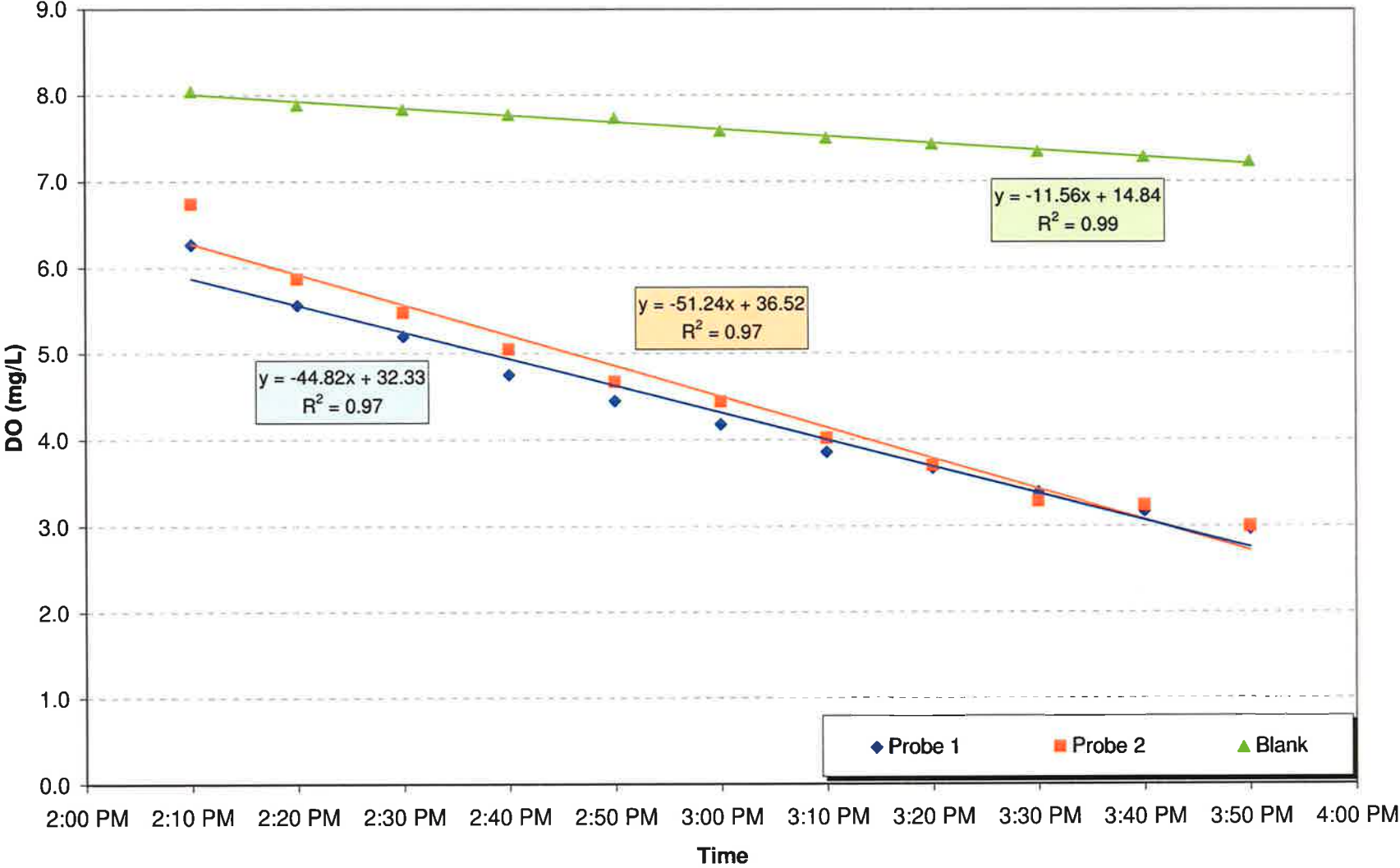


Figure 10: DO VS. Time  
In-Situ SOD Survey - Station EB6

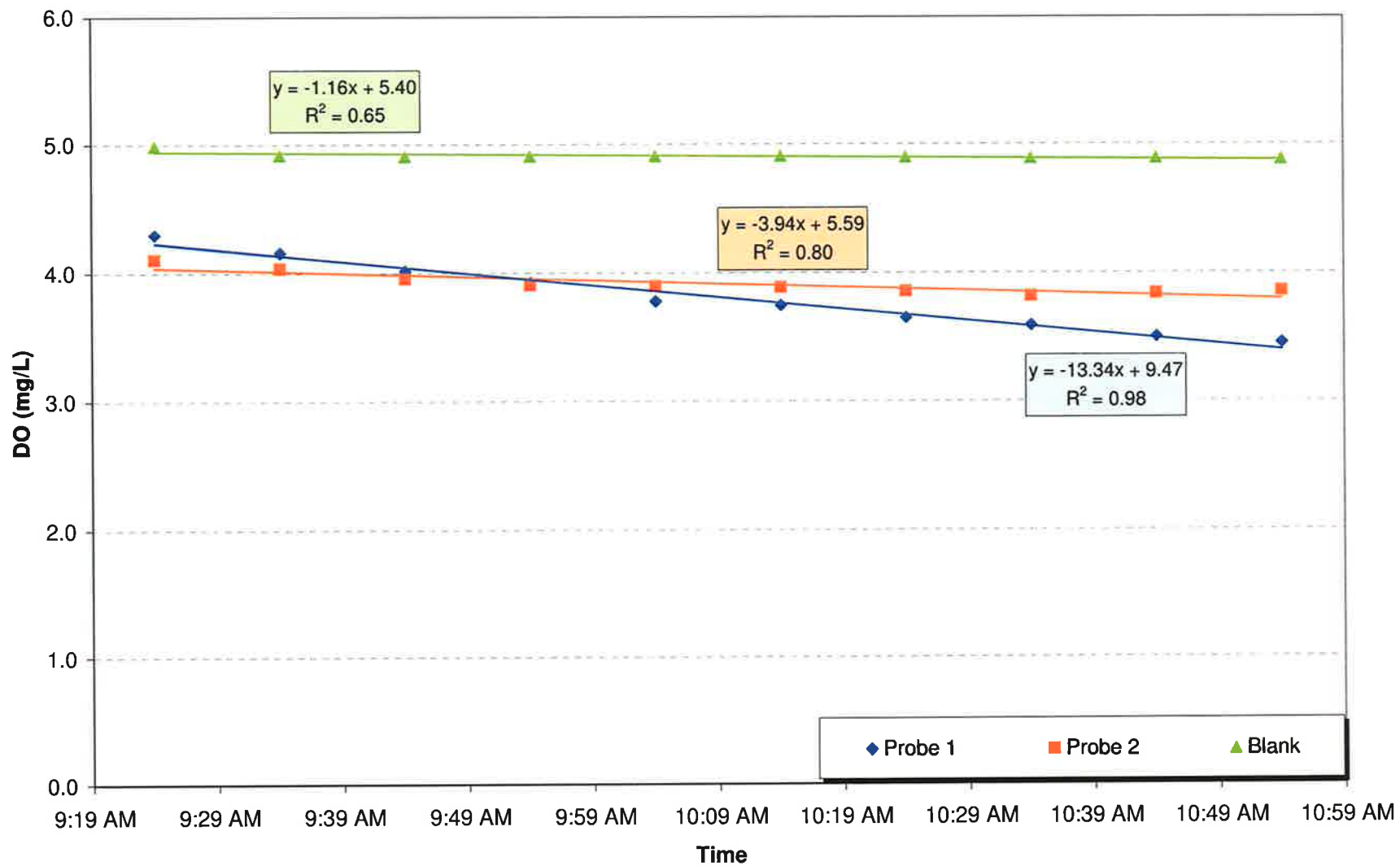


Figure 11: DO VS. Time  
In-Situ SOD Survey - Station EB7

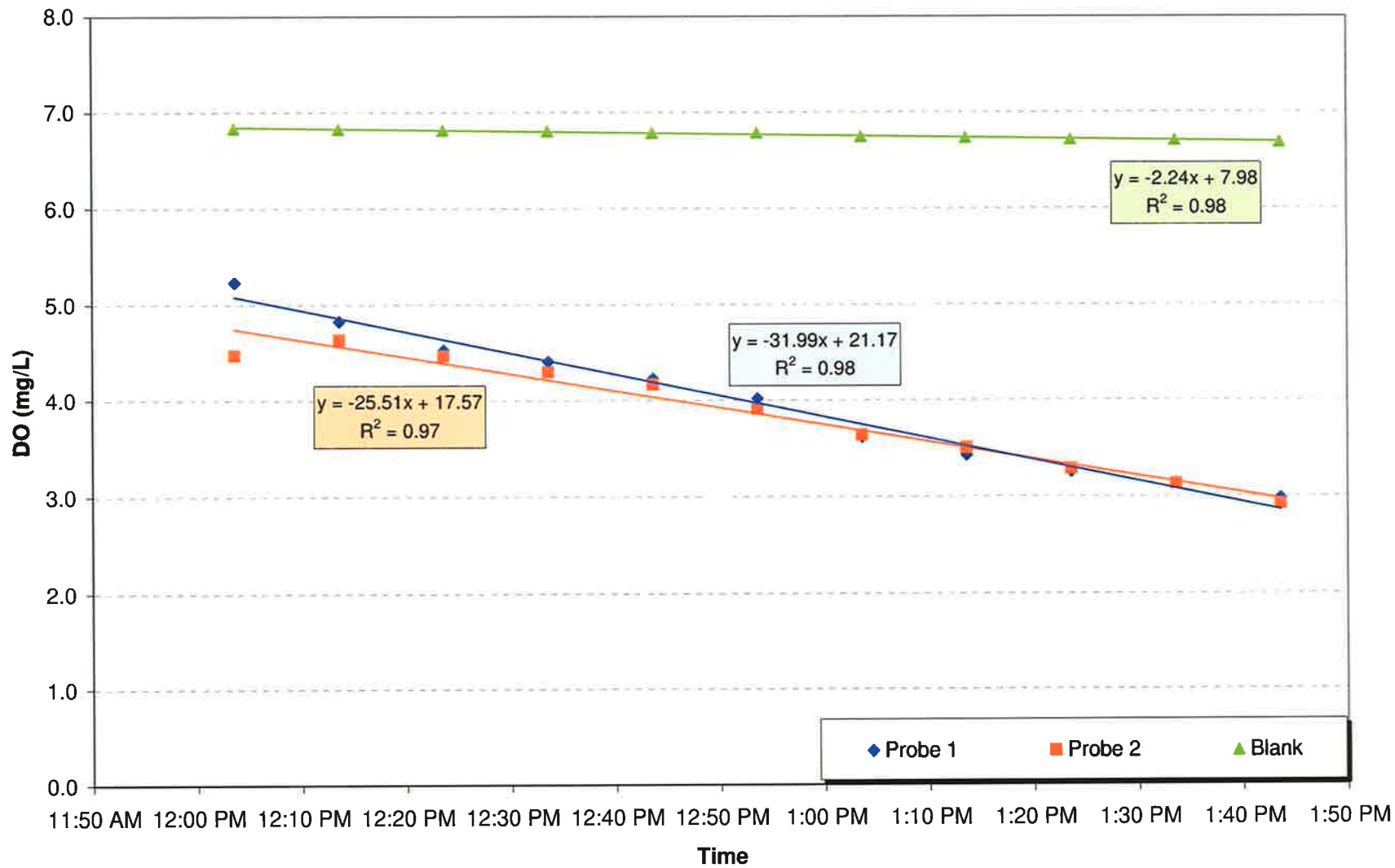


Figure 12: DO VS. Time  
In-Situ SOD Survey - Station EB8

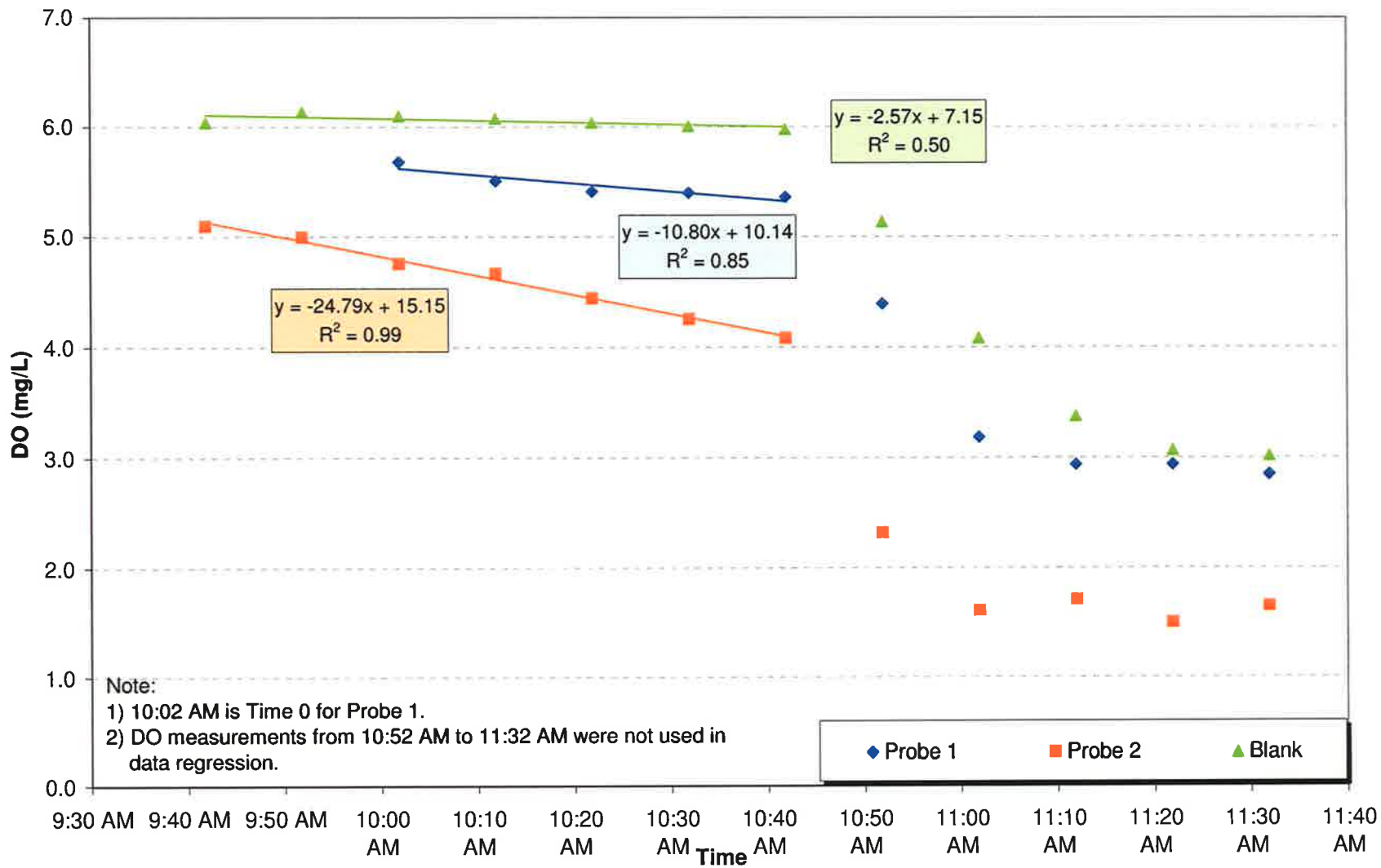


Figure 13: DO VS. Time  
In-Situ SOD Survey - Station SC1

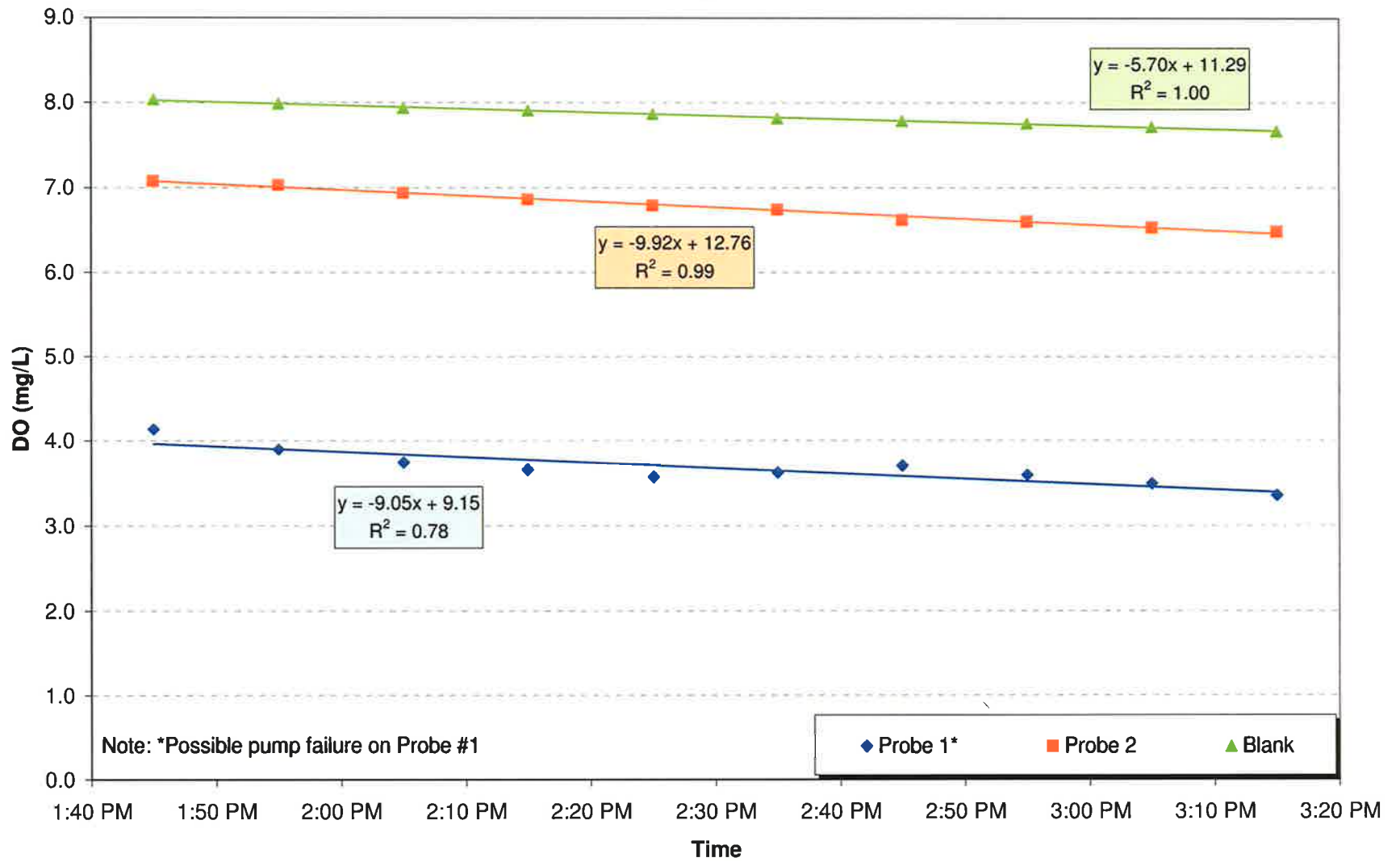




Figure 14: DO VS. Time  
In-Situ SOD Survey - Station SC2

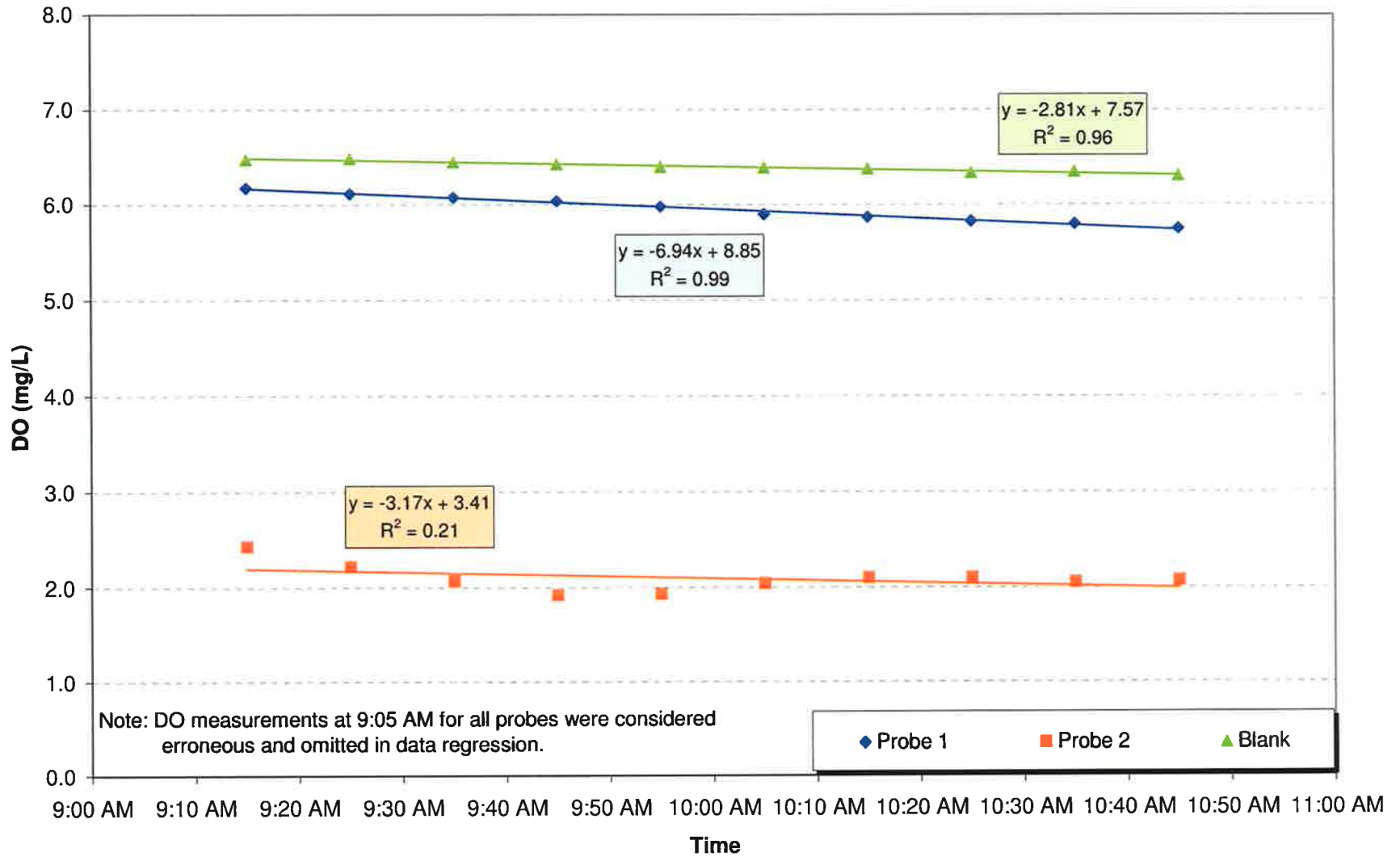


Figure 15: DO VS. Time  
In-Situ SOD Survey - Station SC3

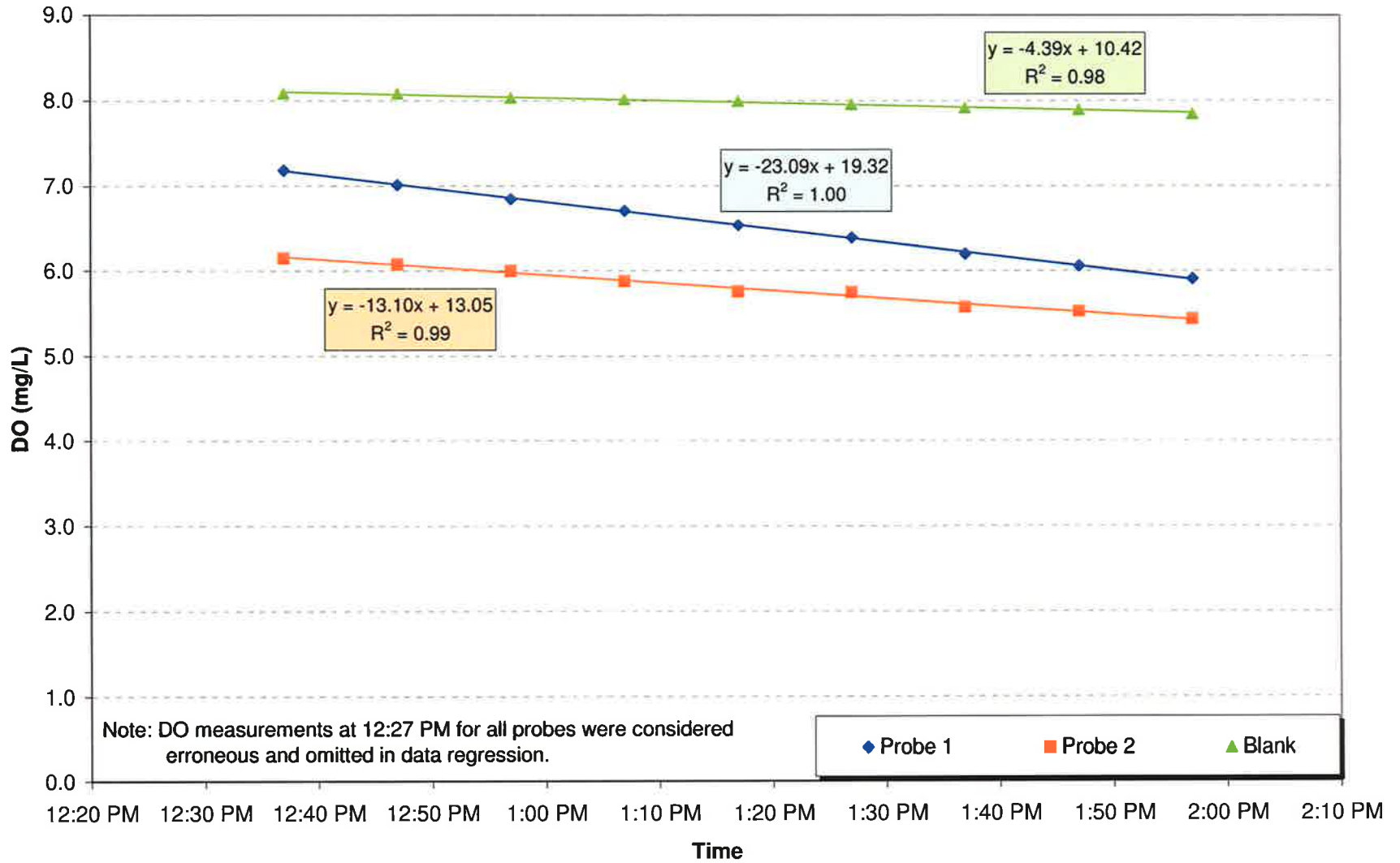


Figure 16: DO VS. Time  
In-Situ SOD Survey - Station SC4

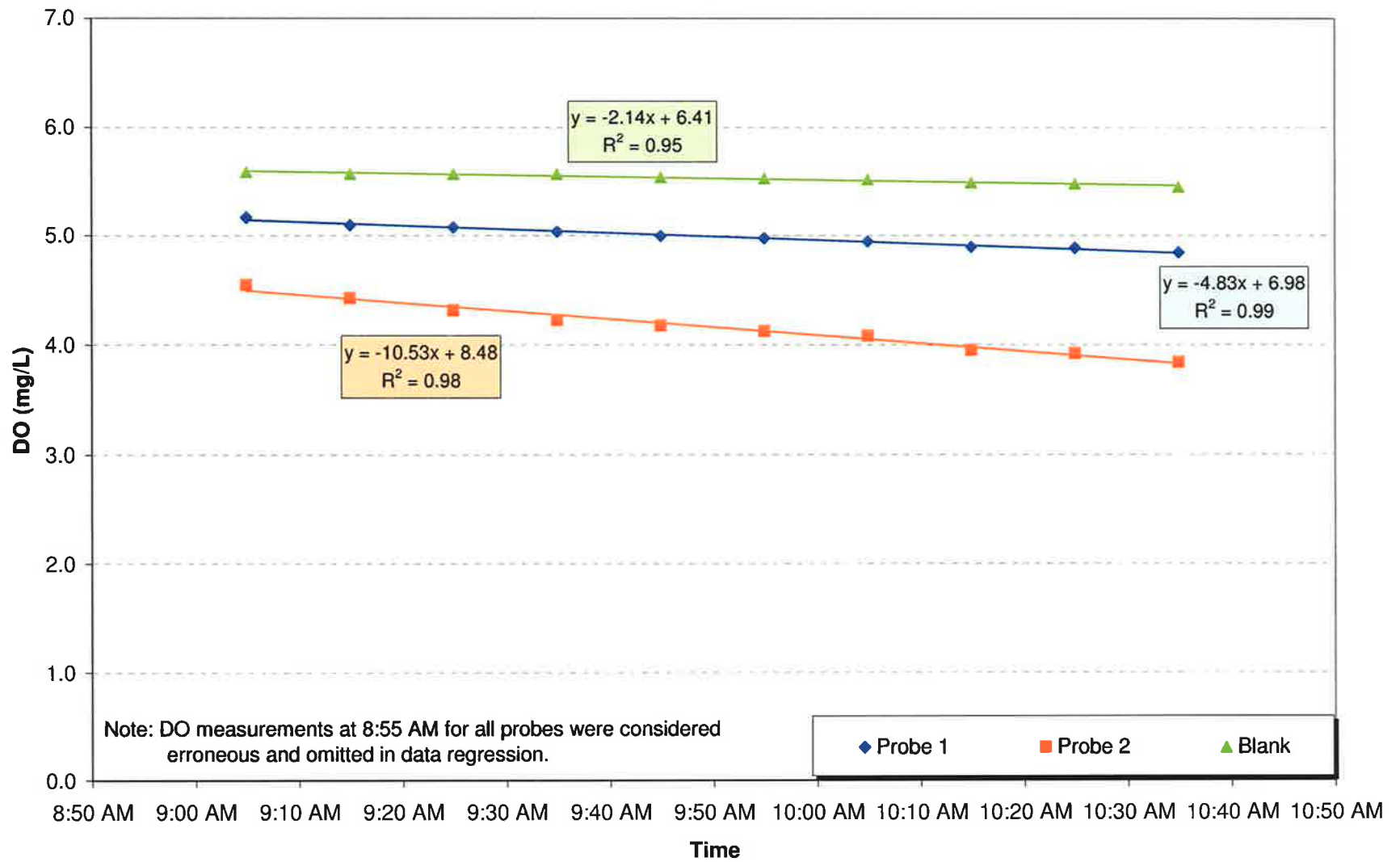


Figure 17: DO VS. Time  
In-Situ SOD Survey - Station SC5

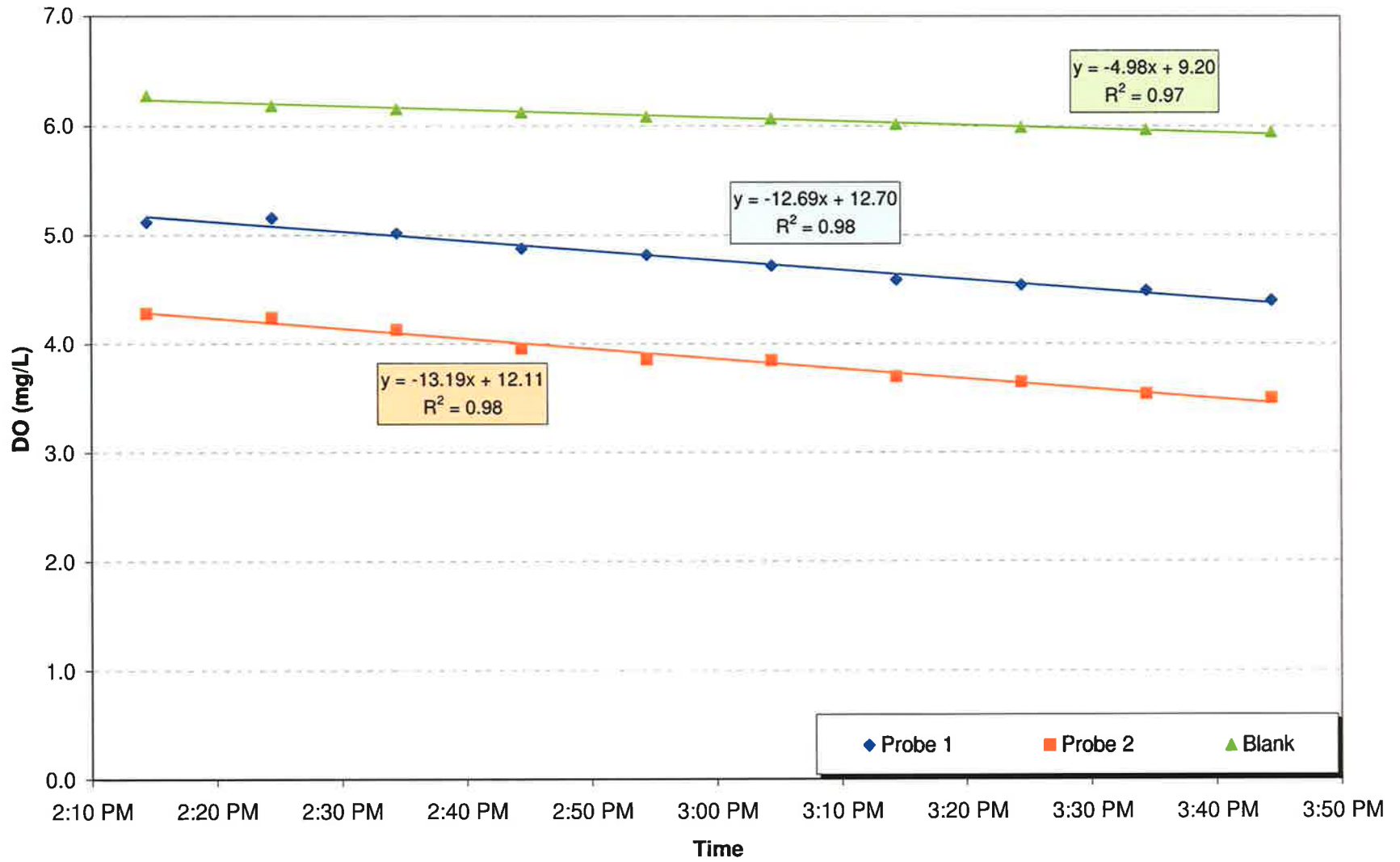


Figure 18: DO VS. Time  
In-Situ SOD Survey - Station SC6

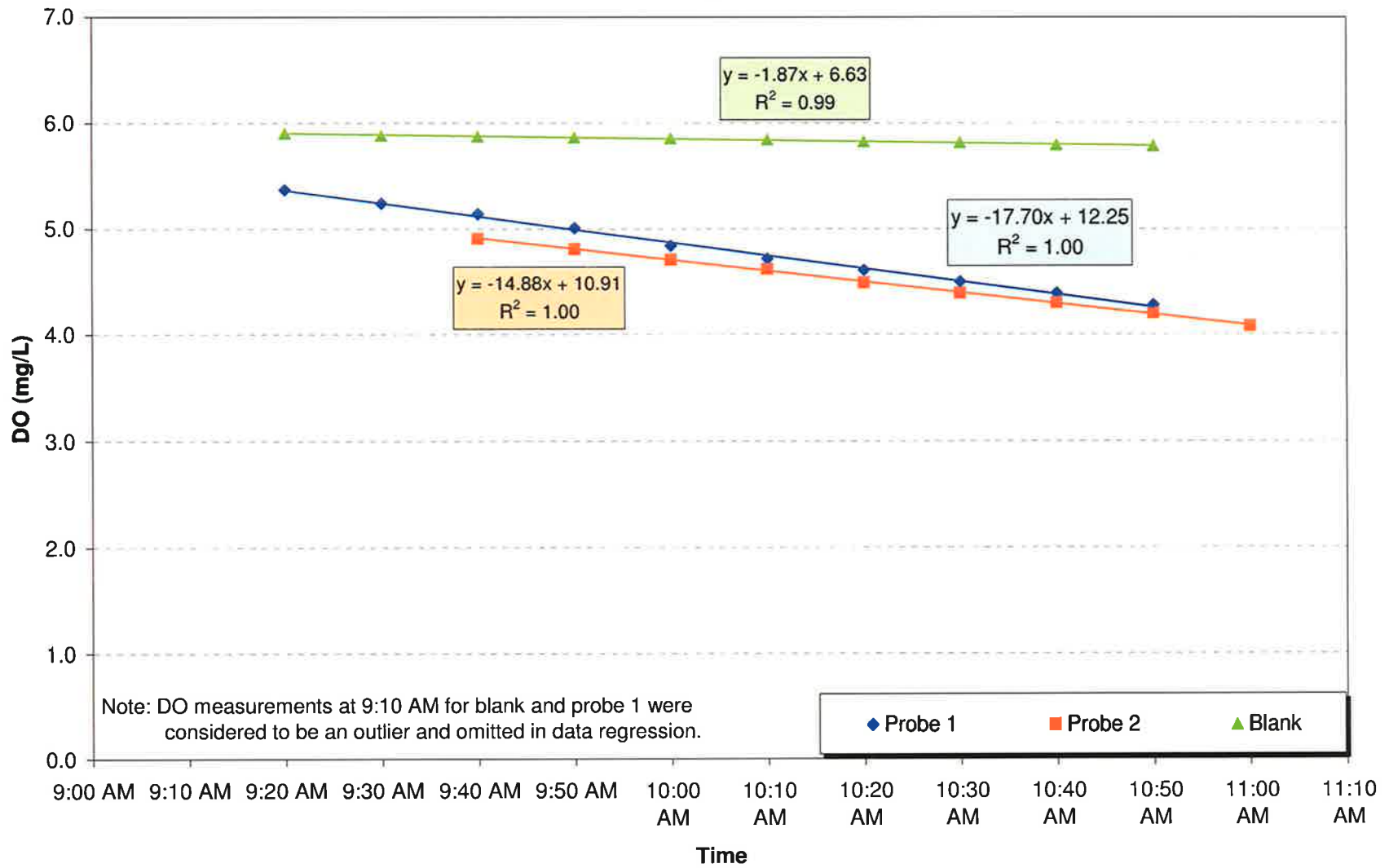


Figure 19: DO VS. Time  
In-Situ SOD Survey - Station SC7

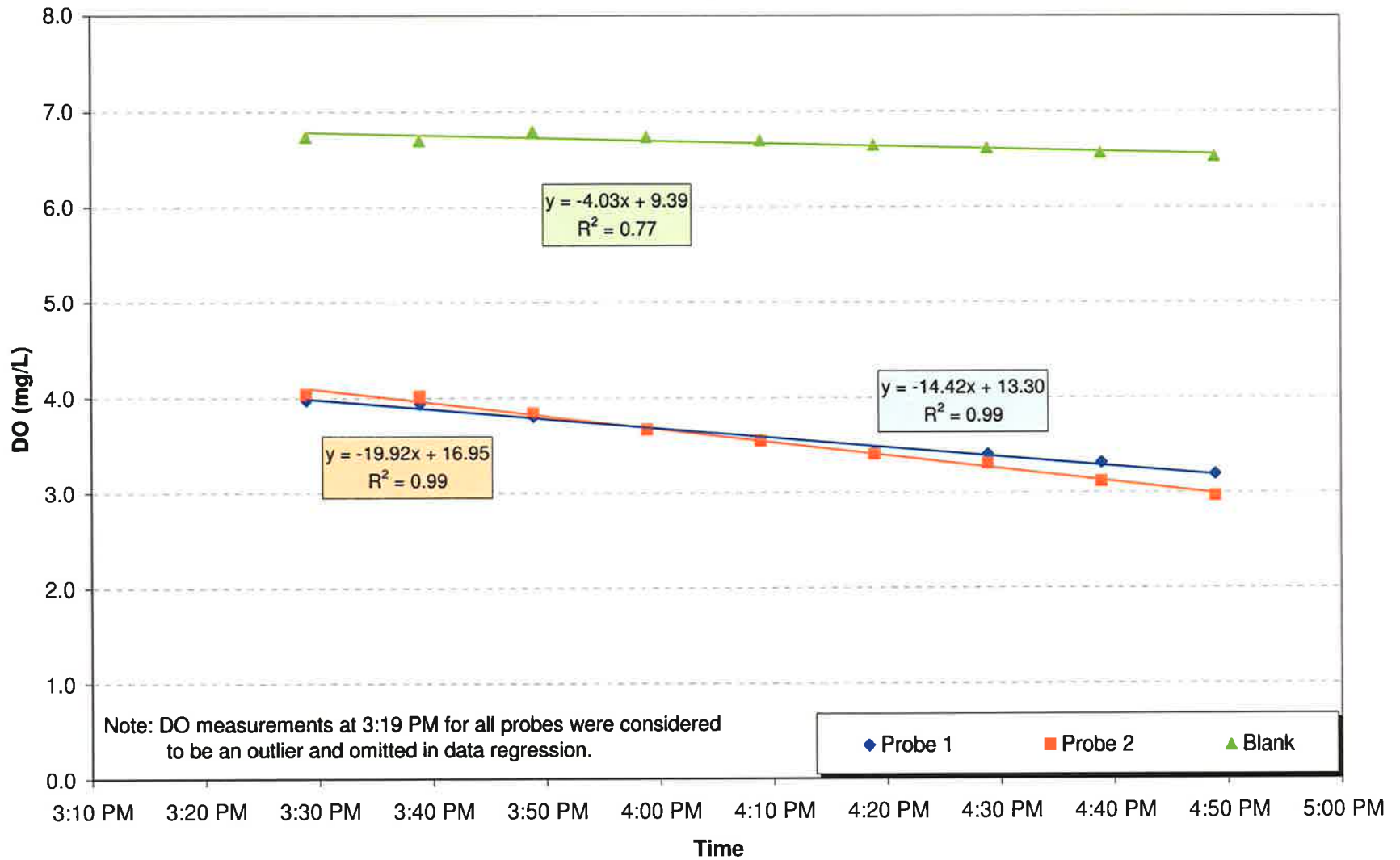
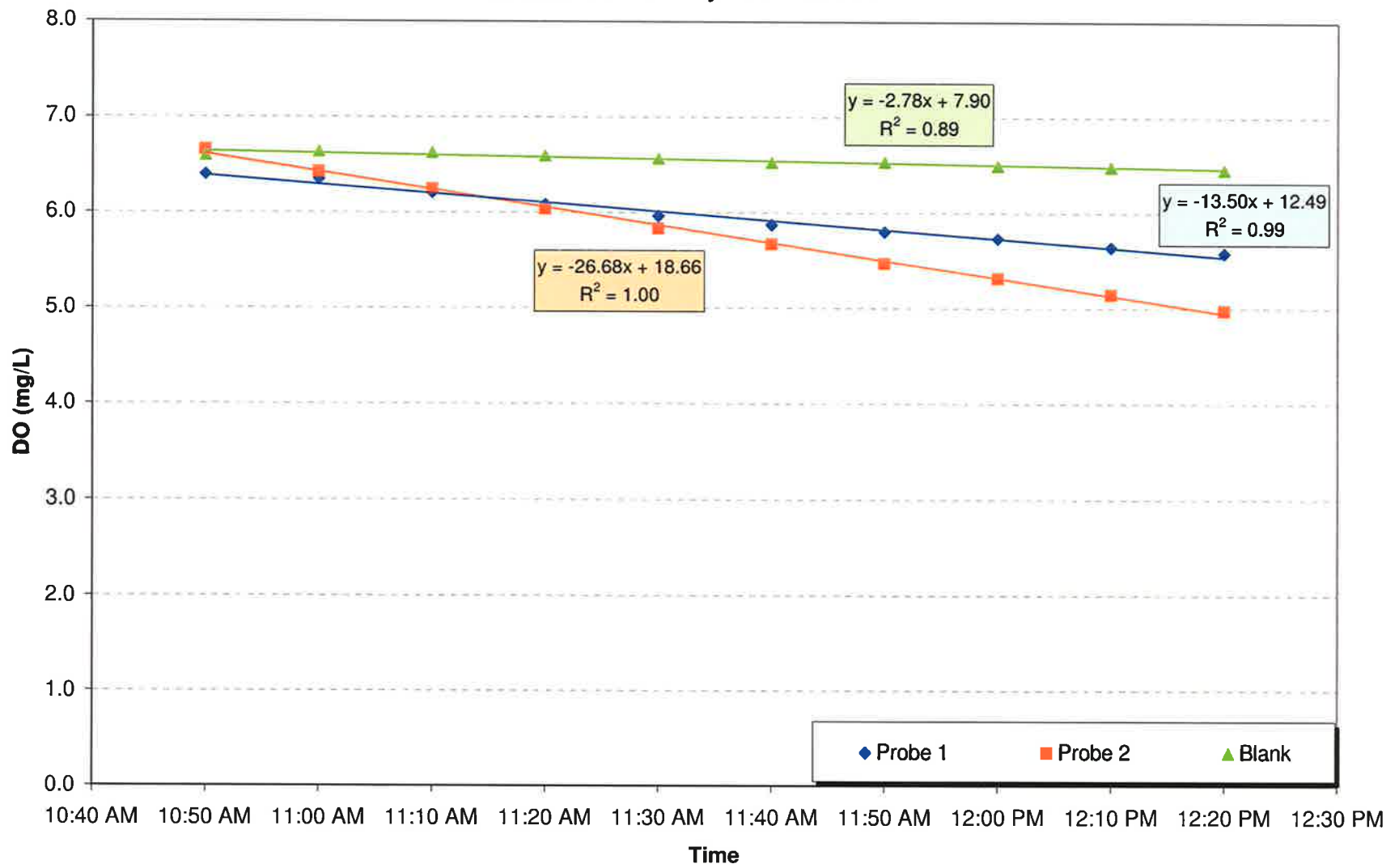


Figure 20: DO VS. Time  
In-Situ SOD Survey - Station SC8



# **ATTACHMENT 1**

**Murphy and Hicks (1986)**

***In-Situ Method for Measuring Sediment Oxygen Demand***



## IN-SITU METHOD FOR MEASURING SEDIMENT OXYGEN DEMAND

Philip J. Murphy and Delbert B. Hicks  
U.S. Environmental Protection Agency, Region IV

**Abstract.** Variations among methods employed to quantify sediment oxygen demand (SOD) have created uncertainty regarding the reproducibility and comparability of results. This paper describes an in-situ method of measuring SOD and discusses equipment design and operational considerations, deployment techniques, and data analyses.

SOD values obtained from this in-situ method and from a laboratory procedure are compared. The in-situ method yields relatively precise results and appears to provide the best estimate of SOD rates since it involves less manipulation of sediments and other environmental factors when compared to the laboratory approach.

**Keywords:** Sediment oxygen demand, SOD methods, in-situ SOD, laboratory SOD, benthic respirometer.

### INTRODUCTION

The effects of oxygen uptake by the benthic environment have long been recognized in the dissolved oxygen balance of rivers and lakes [1, 2, 3, 4]. The need for predictive mathematical models for allocating waste loads to receiving waters has generated an increasing interest in the direct measurement of SOD rates in order to separate its effect from other deoxygenation processes. To date, methods for measuring SOD rates fall into two distinctly different categories: in-situ enclosures or laboratory treatment of sediments removed from the natural setting. The in-situ method appears to be the better approach for measuring SOD because it minimizes manipulation of sediments and other ambient conditions. For example, coring of the substrate results in both horizontal and vertical compaction of sediments. Since the coring device generally encloses a smaller surface area than an in-situ chamber, horizontal compaction by the cutting edge and wall of the coring device affects a much greater proportion of the enclosed sediment surface area than in a larger in-situ chamber. This, in conjunction with vertical compaction, can alter the interstitial environment of the sediment core by reducing sediment pore space and causing possible expulsion of pore water and gases. Compaction perturbations and core handling and processing techniques can translate into alteration of the biological community of the core. Reproducing the physical and chemical water quality conditions for the laboratory experiment does not guarantee the reestablishment of metabolic processes that

were occurring in the sediment core prior to its removal from the ambient location.

Another advantage of the in-situ method is that it allows the investigator to assess the quality of the data before leaving the sampling site. Should the data indicate some peculiar trend or a large degree of variability, additional sampling can be conducted to aid in explaining the observations or reduce sample variation. The laboratory method does not have this level of flexibility. Sediment samples must be returned to the laboratory for testing and several days may elapse before the data can be assessed. The laboratory method, however, shows promise as a research tool because it allows the sediment environmental conditions to be controlled for experimental purposes.

Accepting the view that in-situ measurement of SOD rates avoids experimental perturbations to the sediment associated with the laboratory method, then what is needed is a standardized in-situ method that meets the criteria of consistency, reproducibility, and efficiency as suggested by Bowman and Delfino [5]. Without some consistent and reproducible method to follow, determining real differences in data sets is impossible.

The purpose of this paper is to present a standardized method developed and employed by EPA, Region IV, for the in-situ measurement of sediment oxygen demand. The paper discusses the design and operational considerations for in-situ measurement equipment and reports EPA's chamber specifications and deployment protocol. The precision of the EPA in-situ SOD measurements is examined. SOD values obtained from EPA's in-situ method and from a laboratory method used by the Tennessee Valley Authority are compared.

#### IN-SITU METHOD -- EQUIPMENT AND PROCEDURE

The term "in-situ method" simply means the measurement is made in the original location as opposed to a laboratory treatment of the sediments removed from the study site. In general terms, an in-situ SOD measurement involves isolating a known volume of water and area of sediment under an opaque chamber placed on the bottom. The dissolved oxygen concentration in the chamber water is monitored until sufficient time has elapsed to establish a measurable rate of change in DO concentration. The SOD rate is then calculated using Equation 1:

$$SOD = 1.44 \frac{V}{A} (b_1 - b_2) \quad (1)$$

where SOD is the sediment oxygen demand rate, in  $g/m^2 \cdot day$ ;  $b_1$  is the rate of change of DO concentration inside the SOD chamber, in  $mg/l \cdot min$ ;  $b_2$  is the rate of change of DO concentration inside the "blank" chamber, in  $mg/l \cdot min$  ( $b_2$  is, in effect, the water column respiration rate in the chamber);  $V$  is the volume of the chamber, in liters;  $A$  is the area of chamber, in square meters; and 1.44 is the constant converting  $mg/l \cdot min$  to  $g/m^2 \cdot day$ . Values for  $b_1$  and  $b_2$  may be determined graphically or from a linear regression analysis, where  $b_1$  and  $b_2$  are the slopes of the curves obtained by plotting SOD chamber and blank chamber DO concentrations versus time.)

## IN-SITU METHOD

309

Equation 1 identifies the key factors in the SOD measurement: (1) chamber volume, (2) chamber surface area, (3) rate of change in DO concentrations, and 4) time. These factors are important considerations in deciding the size and shape of the chambers.

#### Chamber Design and Equipment

**Shape of In-Situ Chamber.** The design and shape of in-situ chambers have varied to include cylinders [6, 7, and 8]; modified rectangles [8]; prisms [9, 10]; and annular enclosures [11]. In designing an SOD chamber, there are practical and technical objectives that must be met. Utility of the chamber for diverse sediment types should be the practical objective. Technical objectives focus upon the ability to sustain near ambient conditions within the chamber while conducting replicate measurements with good precision and accuracy. From a practical standpoint, the chamber should be easy to handle and deploy, easily purged of trapped air, remain stable and sealed in high currents, and be suitable for use over various types of substrates and over a broad range of SOD rates. Technical considerations affecting chamber utility that must be addressed are volume to surface area ratio, circulation pattern, and over-bottom current velocity within the chamber. Since the technical considerations directly affect the quality of the measurement and resulting data more than the practical considerations, they are addressed more extensively in the following sections.

**Volume to Surface Area Ratio.** Although the shape and size of an SOD chamber are important, achieving the appropriate volume to surface area ratio ( $V/A$  in Equation 1) in conjunction with these two factors is an important initial consideration in chamber design. The volume to surface area ratio will dictate a wide variety of operational considerations in the in-situ SOD measurements including: (1) the amount of dissolved oxygen available in the chamber, (2) the range of SOD rates capable of being sampled or, to some degree, the utility of the chamber over a variety of substrates, (3) the rate of change detection capability, (4) the time required to conduct SOD experiments, and (5) resuspension effects.

In determining the appropriate surface area to volume ratio, an awareness of the expected range of SOD rates to be encountered and a knowledge of the precision and accuracy of DO measuring capability is required. With anticipation of the range of rates to be measured, the chamber volume should be large enough to ensure that sufficient dissolved oxygen is available within the chamber to sustain the field measurement. If the volume is too small, resuspension effects (an initially rapid decline in DO that usually stabilizes) or a high SOD may deplete the dissolved oxygen before a sufficient number of observations, or data points, have been obtained to calculate an SOD rate. Conversely, if the volume is too large, relative to surface area, changes in the DO concentration of the enclosed water mass may be too small to measure with reasonable analytical accuracy within a reasonable time.

DO changes in the chamber can be measured with either chemi-

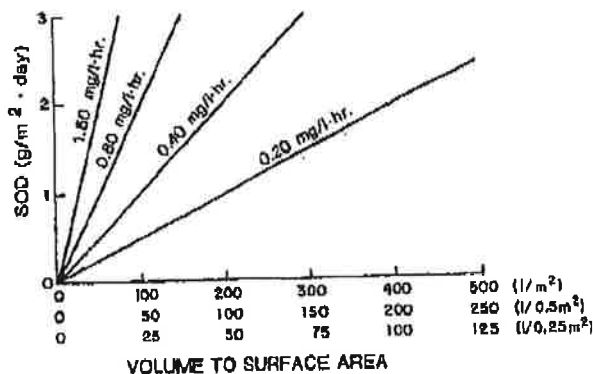


Figure 1. Graphical form of the equation,  
 $SOD = 1.44 V/A (b_1 - b_2)$ .

cal analyses or electronic oxygen probes. The DO probe is generally recommended because it allows the chamber DO to be monitored continuously without extracting water samples from the chamber. Appropriately maintained and calibrated DO probes and meters can be used to monitor DO rates of change as low as 0.05 mg/l per 15 minute interval with precision and accuracy. With this range of DO detection capabilities in mind, coupled with knowledge of the range of SOD values generally reported in the literature and some assumed volume to surface ratios, Equation 1 can be depicted in a graphical form (Figure 1).

Using Figure 1, several operational considerations can be examined with respect to volume to surface area ratios. For a given SOD rate (vertical axis), minimizing the volume to surface area ratio of a chamber increases the rate of change in the DO concentration of the enclosed water mass. The accuracy of the DO determinations is enhanced because of the larger changes encountered during short time periods. Maximizing the volume to surface area ratio obviously has the opposite effect and can result in rates of change too small to detect within a reasonable period of time. The minimization approach also expands the utility of the chamber to be used over a greater variety of substrate conditions with regard to sediment oxygen demand. Also, less time is spent on station. Reducing the experimental time the chamber is in place also diminishes the "bottle effect." In organically enriched water, slime growths can rapidly develop on the chamber wall. Respiration effects of the slime on the DO

## IN-SITU METHOD

311

regime of the enclosure could unknowingly be included in the calculated SOD.

One disadvantage of minimizing the volume to surface area ratio of the chamber is that the total DO resource of the enclosed water mass is decreased. This becomes an important consideration in terms of resuspension effects when the chamber is deployed. Excessive resuspension above levels associated with normal mixing can cause a rapid, short-term decrease in the DO content of the chamber (Figure 2). This effect, coupled with a high SOD rate, could deplete the DO resource before a representative SOD rate can be measured.

Similar surface to volume ratios can be met with a variety of chamber shapes, so one need not be limited to a specific configuration. However, the designer/user must be aware that certain configurations are more thoroughly and uniformly mixed than others. Additionally, the chamber design should allow easy handling both in a boat and underwater by divers under adverse sea conditions, and deployment over a variety of sediment types. A discussion of the more desirable features follows.

**Chamber Mixing.** The purpose of circulation within an SOD chamber is to obtain uniform DO concentrations throughout the

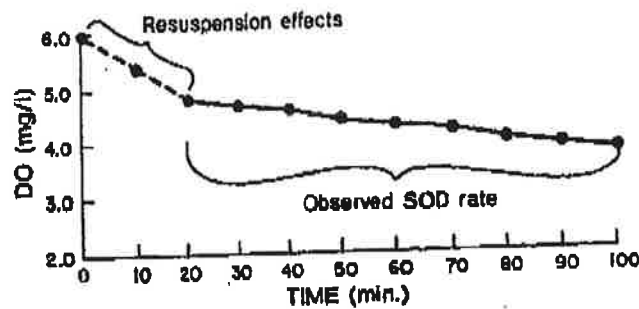


Figure 2. Typical graph of D.O. concentrations measured inside the in-situ S.O.D. chamber, showing initial rapid D.O. decline due to resuspension of oxygen demanding materials during chamber placement. The observed oxygen depletion rate ( $b_1$  for Equation 1) is the slope of the portion of the graph which is not affected by the initial resuspension.

chamber and to produce over-bottom currents of a known velocity. Complete mixing of the chamber is essential to ensure that the "effective volume" for SOD rate calculations (Equation 1) is equal to the total chamber volume. Without complete mixing, portions of the enclosed water mass might be influenced to varying degrees by the benthic metabolism.

Historically, chamber circulation has been achieved through pumps and diffusers or propeller systems. Commercially available self-stirring oxygen probes are not adequate and should not be depended upon as the sole source of chamber circulation since they circulate too little volume to effectively mix the chamber. Diffusers or propellers in the chamber should be oriented to achieve complete mixing within the chamber, provide reasonably uniform over-bottom velocities, and avoid excessive disturbance and resuspension of bottom sediments.

**Chamber Over-bottom Velocity.** The importance of chamber mixing and over-bottom velocities to the measurement of SOD has been reported by Boynton, et. al. [11] and Whittemore [12]. Ideally, over-bottom velocities should approximate ambient velocity at the test site, but such simulation is difficult to obtain. For instance, in a tidal system, simulating the constantly changing over-bottom velocities would require monitoring the instantaneous current speed and continuously adjusting the output of the circulation mechanisms through rheostats. When DC battery power is used as the power source, which is practical for mobile field operations, it is very difficult to use and calibrate rheostats for 12v DC voltage. Considering these difficulties, we suggest using a fixed mixing rate with a constant over-bottom velocity low enough to avoid excessive resuspension and within a range of velocities typical of the study site. Since SOD rates are affected by over-bottom velocities, one benefit of a fixed or uniform mixing rate is that it standardizes the experiment in terms of velocities when compare and contrast studies are planned such as assessing pre and post dredging impacts on SOD. However, for modeling purposes, simulating ambient overbottom velocities, as nearly as possible, should be a goal of any experiment. Accordingly, measurement and reporting of ambient and chamber velocities should be a part of all SOD studies.

**Detecting Resuspension.** Resuspension, which increases apparent SOD, can often be detected through graphic analysis of DO concentration versus time (Figure 2). The chamber design by Lucas and Thomas [9] provided an effective means to assess suspension of material in the enclosure. Chamber water was circulated through a clear Plexiglas manifold external to the enclosure. The manifold was equipped with a sampling port and septum so that small aliquots could be removed for analyses during or after the experiment. If sampling is to be done during the experiment, the chamber should have an inflow port for renewing water lost to sampling; otherwise, negative water pressure may pull sediment pore water into the chamber water.

**Pump Specifications.** Regardless of the system chosen for circulation, it is advisable to avoid pump or propeller systems

## IN-SITU METHOD

313

that do not have a completely sealed motor. Impeller or propeller shafts connecting directly to the motor and sealed only by an O-ring or similar bearing-type device are subject to leakage into the motor compartment. This problem increases with depth due to increased water pressure. Pump electrical shortages become a frequent problem, often terminating the experiment before completion; perhaps without the knowledge of the operator. Pump systems using magnetically driven impellers are less likely to have electrical shortages. The pump operation and battery performance can be monitored (1) by placing an amp meter in the electrical circuit or (2) by passing the pump flow over the DO probe (9). This second procedure eliminates the need for a probe stirring device, if the velocity of pump water over the membrane meets the specifications of the probe's manufacturer. Should the pump output cease, a rapid decrease in the DO reading will occur.

**Chamber Flange and Cutting Edge.** An SOD chamber should be equipped with a flange and cutting edge along its perimeter of contact with the sediment. A horizontal flange and vertical cutting edge effectively stabilize and seal the chamber to the sediment surface. In soft sediment, the flange limits the chamber's intrusion into the sediment, thus ensuring a known chamber volume. In harder substrates and rubble where penetration of the cutting edge is limited, the flange may be fitted with a soft flexible collar to aid in sealing the chamber to the substrate. This modification may require recalculating the volume of the enclosure.

**Preventing and Detecting Chamber Leakage.** An effective chamber to substrate seal is essential to prevent ambient water from leaking into the chamber and altering the chamber DO concentration. An effective chamber seal can usually be made when divers are used to place the chamber on the bottom substrate. Deployment by divers can minimize many uncertainties in dome placement, particularly regarding whether or not the chamber is sealed as well as such things as substrate type and presence or absence of benthic macrophytes. Where diver deployment is not possible, the chamber seal's integrity can be tested by remotely injecting a saturated salt solution (KCl) into the chamber. The resulting increase in conductivity is monitored to detect declining values after stabilization, indicating a leak of ambient water into the dome. Use of the salt solution is, of course, only practical in fresh water. The conductivity of brackish and sea water is too high for effective use of this option.

**Purging of Chamber.** The chamber should be designed with a one way purging port or movable lid to emit water and trapped air as it is lowered through the water column. Passing of water through the chamber as it is lowered helps assure that ambient bottom water is ultimately enclosed within the chamber for the SOD experiment and, further, reduces shock wave disturbance and resuspension of the bottom sediment upon impact. The lid or port can then be closed either remotely or by divers, depending on the method of deployment.

## Accounting for Water Column Respiration Rate

The declining DO concentration measured in the chamber ( $b_1$  in Equation 1) reflects both the sediment oxygen demand and the oxygen demand of the water trapped under the chamber. To calculate the SOD rate, the water's oxygen demand must be measured and subtracted from the total oxygen demand measured in the chamber. The water column oxygen demand ( $b_2$  in Equation 1) is due to respiration of suspended algae and bacteria, as well as the effects of slime growth on the chamber wall. The water column oxygen demand can be measured by use of "blank" chamber experiments conducted simultaneously with the SOD experiments. A "blank" is a chamber identical to the SOD chamber but with a bottom that isolates chamber water from the sediment. The "blank" chamber is deployed alongside the SOD chambers, filled with bottom water, then subjected to the same conditions of water temperature, circulation, monitoring, etc. as the SOD chamber.

Although the "blank" chamber serves as a large BOD bottle, standard size BOD bottles do not appear as a good alternative to "blank" chambers to obtain water column respiration rates for chamber experiments. Comparison of "blank" chambers with BOD bottles (Table 1) has shown that BOD bottle tests tend to overestimate water column respiration occurring within the chamber. This is possibly due to differences in the ratio of volume to surface area for the BOD bottles and "blank" chamber.

TABLE 1. Comparison of Water Column Respiration Rates Determined Using Dark BOD Bottles and "Blank" Chambers.<sup>1</sup>

Location	Dark BOD <sup>2</sup> Bottle, mg/l·hr	"Blank" SOD Chamber, mg/l·hr
Estuarine; bay	.031	.011
Estuarine; bay	.017	.008
Estuarine; bay	.000	.009
Estuarine; bay	.065	.056
Estuarine; bay	.050	.015
Estuarine; bay	.266	.076
Estuarine; bay	.120	.057
Estuarine; bay	.084	.032
River (Fresh)	.013	.000
River; Estuary	.089	.057
River; Estuary	.089	.000
River; Estuary	.150	.014
Estuarine Lake	.046	.076
Tidal Creek	.075	.108
River Impoundment	.133	.070
River Impoundment	.139	.040
River Impoundment	.046	.022
River Impoundment	.125	.049
River Impoundment	.041	.000

<sup>1</sup>Data measured by EPA Region IV.

<sup>2</sup>Average of two bottles.



## IN-SITU METHOD

315

## E.P.A (REGION IV) EQUIPMENT, PROCEDURE AND RESULTS

## Specifications for EPA's SOD Chamber

An SOD chamber designed and operated by EPA, Region IV, is shown in Figure 3. The chamber is basically a cylinder with a center core that gives an annular configuration. The lid, with attached center core, is mounted to the base via four stanchions which guide the lid closed when the chamber is seated in the sediment. The lid is secured in the open position during deployment, which facilitates purging of the chamber as it passes through the water column. Divers seat the chamber, then lower and secure the lid into the closed position. The length of the center core is such that it also seats in the sediments. The chamber in the deployed position isolates 65 liters of water over 0.27 m<sup>2</sup> of substrate.

Water is circulated within the chamber by a 12-volt DC magnetically coupled pump delivering approximately 600 l/hr (160 gal/hr) with diffusers. Because of the annular design (Figure 3) and orientation of the diffusers, a unidirectional flow of 2.4 to 3.1 cm/sec (0.08 to 0.10 ft/sec) is attained over the bottom. Velocity measurements were made over a sand substrate.

Once the chamber and lid are sealed, divers insert calibrated probes into the chamber for monitoring DO and temperature. The chamber shown in Figure 3 is intended primarily for diver deployment and servicing. As mentioned earlier, diver deployment can eliminate many problems associated with remote placement of a chamber and is recommended when possible.

## Field Procedure for SOD Studies

The following procedures are recommended for conducting field measurements of sediment oxygen demand using the previously described equipment.

- (1) Obtain preliminary information about the study area to determine general sediment types and current velocities.
- (2) Calibrate dissolved oxygen meters and other monitoring equipment such as salinometers, conductivity meters, and DO equipment and recorders. Maintain record of calibration. A DO probe having a stirring device is required in order to maintain appropriate water velocities across the membrane of the probe.
- (3) Measure vertical profiles of dissolved oxygen, temperature, salinity or conductivity, and measure bottom velocities. Near bottom concentrations of dissolved oxygen less than 2 mg/l are generally inadequate for the SOD determination. Attempts at measuring SOD rates under such conditions must be done with great caution or the dissolved oxygen will be depleted within too short a period of time.
- (4) Check delivery of power and operation of circulation pump.
- (5) Deploy chambers. Lower the chamber with rope from a boat or the river bank. When on bottom, divers place, position, and seal chamber. Deploy blank chamber first and position upstream from other chambers. Purging of blank chamber with bottom water occurs while other chambers are being deployed.

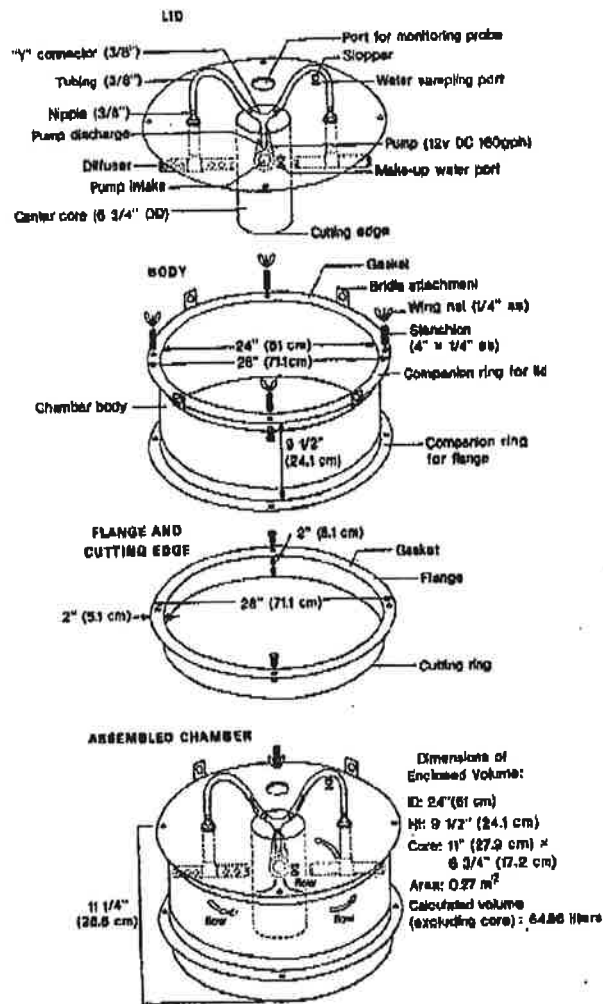


Figure 3. Diagram of the in-situ SOD chamber.

## IN-SITU METHOD

317

(6) Allow approximately 20 minutes for settlement of material that might have been resuspended during deployment of chamber. Install monitoring probes and engage circulation pump. Secure probe into hole in lid with number 12 rubber stopper fitted to probe housing. Terminate purging of blank chamber when monitoring probe is installed. A purging period of 20 minutes allows the chamber contents to turn over approximately three times.

(7) Lower ambient probes to dome level; approximately one foot above bottom.

(8) Record initial monitoring data.

(9) Deploy a minimum of two dark bottles alongside the chambers for incubation during the course of the SOD experiments. Use water column respiration values obtained from the dark bottles as back-up to blank chamber experiments in case of chamber failure. General procedures for conducting the light-dark bottle tests are provided in Standard Methods, 15th Ed.

(10) Record monitoring data either continuously or at 15 minute intervals.

(11) Continue experiment for approximately 2 hours. Oxygen readings at 15-minute intervals provide sufficient data points (6-9) for determining the slope of the DO curve.

(12) Remove monitoring probes from dome and check their calibration. Record calibration check. Check operation of circulation pump just prior to termination of experiment.

(13) Relocate dome to nearby position and begin replicate measurement. Use of additional chambers as replicates will eliminate need for relocation of chambers. Four to six replicates are suggested. Allow dark bottle experiment to continue.

## SOD Data Measured by EPA, 1977-1984

The above in-situ method, with some equipment variation, has been employed by EPA Region IV personnel since 1977. Data measured by this method (1977-1984) are summarized in Table 2. The method has been used in a variety of areas including creeks, rivers, lakes, canals and estuaries. Equally diverse is the array of SOD rates observed, which demonstrates the need for site specific observations. The variability about the mean is due to natural variation in the benthic environment and variation inherent in the sampling method employed. The purpose of standardizing the SOD methods in terms of equipment and procedure is to minimize the variation in the method.

The range and coefficient of variation (C.V.) identify the variation about each of the means reported in Table 2. By inspection, 91 percent of the coefficient of variation values are less than 40 percent. The central tendency for the distribution of these values is between the 10 and 20 percent level. For biological sampling under field conditions, a coefficient of variation of less than 50 percent is viewed as acceptable [13]. The method used by EPA personnel in Region IV appears to provide consistent and relatively precise estimates of sediment oxygen demand.

TABLE 2. SOD Rates Measured Using EPA In-situ Chambers, 1977-1984.

Location	Description	SOD Rates			Mean Temp., °C.
		Mean, $\mu\text{Mm}^2/\text{m}^2\cdot\text{hr}$	Range, $\mu\text{Mm}^2/\text{m}^2\cdot\text{hr}$	C.V., %	
Indian River, Fla.	High velocity lagoon	.12	.10-.14	23.6	30.0
Eykes Creek at Merritt Is., Fla.	Saltwater tidal creek subject to urban runoff and STP	.31	.12-.69	21.0	21.8
Turkey Creek at Melbourne, Fla.	Density stratified tidal creek stream residential development, heavy organic deposit	.54	.49-.60	14.3	32.4
Indian River at Turkey Creek Melbourne, Fla.	Estuary	.12	.11-.22	26.4	32.0
Sugarloaf Key, Fla.	Deadend Canal, hypersaline	.12	.10-.14	23.6	25.0
Wilson Creek, S. C.	Shallow, flashy, piedmont creek	.10	.09-.11	10.7	23.4
Wilson Creek, S. C.	Shallow, flashy, piedmont creek	.08	.05-.14	26.0	24.0
Wilson Creek, S. C.	Shallow, flashy, piedmont creek	.12	.07-.19	20.4	25.1
Mobile Bay, Ala.	Low salinity estuary	.12	.10-.13	16.7	26.0
St. Andrews Bay, Fla.	Estuary	.04	.03-.06	20.0	28.0
St. Andrews Bay, Fla.	Estuary; near retired kraft mill discharge	.15	.08-.23	23.0	28.0
Savannah River at Savannah, Ga.	Density stratified, high velocity river/estuary	.027	.021-.033	22.2	24.6
Savannah River at Savannah, Ga.	Density stratified, high velocity river/estuary	.061	.038-.078	20.3	23.2
Savannah River at Savannah, Ga.	Density stratified, high velocity river/estuary	.036	.026-.044	19.4	21.2
Savannah River at Savannah, Ga.	Density stratified, high velocity river/estuary	.41	.37-.45	8.37	22.2
Hillsborough River at Tampa, Fla.	Density stratified river/estuary	.14	.16-.19	6.55	22.0
Hillsborough River at Tampa, Fla.	Density stratified river/estuary	.11	.09-.14	19.72	22.9
Hillsborough River at Tampa, Fla.	Density stratified river/estuary	.17	.12-.19	14.92	23.2
Sarasota Bay, Fla. (Summer)	Shallow bay, grass flat	.165	.148-.183	14.9	29.4
Sarasota Bay, Fla. (Summer)	Open bay, sandy bottom	.227	.172-.357	34.3	29.0
Sarasota Bay, Fla. (Summer)	Open bay, sandy bottom	.156	.145-.166	9.6	28.2
Sarasota Bay, Fla. (Summer)	Deep bay channel, coarse sand	.120	.107-.152	17.5	28.9
Sarasota Bay, Fla. (Winter)	Shallow bay, grass flat	.122	.070-.282	39.6	20.3
Sarasota Bay, Fla. (Winter)	Open bay, sandy bottom	.106	.094-.116	9.5	21.1
Sarasota Bay, Fla. (Winter)	Shallow bay, grass flat	.077	-	-	21.1
Sarasota Bay, Fla. (Winter)	Deep bay channel, coarse sand	.086	.063-.110	27.2	22.0
Whitaker Bayou, Fla. (Summer)	Density stratified creek, thick organic deposits. Subject to urban runoff & STP	.165	.050-.321	43.0	26.9
Whitaker Bayou, Fla. (Summer)	Density stratified creek, thick organic deposits. Subject to urban runoff & STP	.140	.117-.157	12.9	27.7
Sarasota Bay, Fla. at Whitaker Bayou (Summer)	Bay near mouth of tidal creek Subject to urban runoff & STP	.264	.098-.604	46.0	26.4
Whitaker Bayou, Fla. (Winter)	Density stratified creek, thick organic deposits. Subject to urban runoff & STP	.154	.128-.169	14.3	22.0
Whitaker Bayou, Fla. (Winter)	Density stratified creek, thick organic deposits. Subject to urban runoff & STP	.240	.124-.380	26.4	20.5

IN-SITU METHOD

TABLE 2. SOD Rates Measured Using EPA In-situ Chambers

TABLE 2 (continued)

Location	Description	SOD Rates			
		Mean, gC <sub>2</sub> /m <sup>2</sup> -hr	Range, gC <sub>2</sub> /m <sup>2</sup> -hr	C.V., %	Mean Temp., °C
Sarasota Bay, Fla. at Whitaker Bayou (Water)	Bay near mouth of tidal creek Subject to urban runoff & STP	.140	.123-.214	26.3	20.5
Lake Myakka, Fla. (Summer)	Shallow freshwater lake with bottom of dense organic matter	.649	.620-.664	51.0	28.5
Lake Myakka, Fla. (Water)	Shallow freshwater lake with bottom of dense organic matter	.870	.643-.075	7.1	19.7
Lake Myakka, Fla. (Winter)	Shallow freshwater lake with bottom of dense organic matter	.124	.041-.172	36.3	19.2
Gulf Shores, Ala.	Gulf Intracoastal Waterway	.486	.470-.109	18.8	22.5
Gulf Shores, Ala.	Gulf Intracoastal Waterway	.970	.166-.870	9.9	21.5
Gulf Shores, Ala.	Gulf Intracoastal Waterway	.112	.872-.154	32.7	22.0
Guntersville Reser- voir, Ala.	TVA Lake	.143	.136-.222	20.0	25.5
Guntersville Reser- voir, Ala.	TVA Lake	.099	.078-.120	18.4	24.8
Pickwick Reservoir, Ala.	TVA Lake	.037	.628-.066	27.0	23.5
Pickwick Reservoir, Ala.	TVA Lake	.099	.093-.104	5.7	23.6
Hillsborough Bay, Fla.	Density stratified bay, dynamic muck	.433	.023-.040	39.3	16.3
Hillsborough Bay, Fla.	Density stratified bay, sand/mud	.446	.039-.053	20.3	16.0
Hillsborough Bay, Fla.	Density stratified bay at river mouth and STP discharge	.494	.043-.100	8.4	18.9
Sowasho Creek, Mass.	Shallow creek, upstream of STP	.077	.075-.114	19.2	26.2
Sowasho Creek, Mass.	Shallow creek, downstream of STP	.102	.095-.124	18.7	29.5
Trampa Bay, Fla.	Open Bay, sand	.174	.041-.081	24.8	-
Hillsborough Bay, Fla.	Shallow bay, dark mud & silt	.131	.074-.174	35.2	30.2
Trampa Bay, Fla.	Open Bay, sand	.195	.101-.274	21.5	31.0
Old Trampa Bay, Fla.	Shallow Bay, nearshore	.111	.107-.114	3.2	31.0
Trampa Bay, Fla.	Shallow Bay, nearshore	.209	.137-.284	26.5	30.8
Manatee River, Fla.	Tidal stratified river	.077	.046-.107	35.9	31.5
Manatee River, Fla.	Tidal stratified river	.183	.140-.193	10.3	32.0
Manatee River, Fla.	Tidal stratified river	.073	.042-.047	13.7	31.0
Boone Lake	TVA Lake, sludge bank	.146	.171-.465	44.7	-
Boone Lake	TVA Lake, upstream of sludge bank	.072	.071-.073	1.4	-
Boone Lake	TVA Lake, downstream of sludge bank	.041	.037-.0.44	8.8	-
Boone Lake	TVA Lake, HRM 19.1	.031	.028-.036	11.9	14.0
Boone Lake	TVA Lake, HRM 26	.044	.035-.077	12.1	12.5
Boone Lake	TVA Lake, HRM 28	.078	.045-.10	21.7	16.5
Boone Lake	TVA Lake, HRM 31	.109	.065-.14	30.7	16.5
Boone Lake	TVA Lake, HRM 3	.050	.040-.060	17.3	11.8
Boone Lake	TVA Lake, WRM 7	.023	.020-.027	13.3	14.3
Boone Lake	TVA Lake, WRM 11.25	.072	.064-.081	8.4	24.8
Calcasieu River	Stratified river/estuary	.027	.019-.031	20.1	24.0
Calcasieu River	Stratified river/estuary	.027	.017-.019	32.8	24.0
Calcasieu River	Stratified river/estuary	.027	.019-.039	22.0	24.2
Calcasieu River	Stratified river/estuary	.027	.021-.083	15.9	24.2
Calcasieu River	Stratified river/estuary	.055	.034-.073	27.3	24.0
Calcasieu River	Stratified river/estuary	.027	.024-.038	22.3	24.5
Calcasieu River	Stratified river/estuary	.038	.029-.043	14.6	23.0
Charlevoix Harbor	Estuary; seasonal stratification	.052	.034-.070	10.4	17.0
Pine Island Sound	Estuary; shallow	.044	.031-.048	11.8	15.5
Fl. Loudoun Res.	TVA Lake, TRM-608	.046	.041-.049	5.0	24.7
Fl. Loudoun Res.	TVA Lake, TRM-658	.044	.033-.050	17.2	24.8
Fl. Loudoun Res.	TVA Lake, TRM-658	.043	.030-.051	13.9	24.2
Tullio Reservoir	TVA Lake, LTRM-25.6	.048	.042-.054	12.5	-
Tullio Reservoir	TVA Lake, LTRM-21	.047	.039-.045	11.3	14.1

### COMPARISON OF IN-SITU AND LABORATORY S.O.D. MEASUREMENTS

In-situ SOD rates are compared to rates derived by a laboratory method of measuring SOD (Table 3). The laboratory method for measuring SOD rates is described by TVA in Appendix A. In three of the four data sets compared, TVA's laboratory method yielded rates substantially lower than rates measured with the in-situ method. Other researchers [14, 15, 16, 17] also report a discrepancy between in-situ and laboratory SOD measurements. Suspect in the tendency towards lower rates by the laboratory method are the physical and biological changes that occur in the sediment sample during collection, transfer, and storage and the restructuring of environmental conditions during the experimental process. With biological process being a major component of sediment oxygen demand [11, 18, 19, 20], changes to the structure of the microbial community and its metabolism are of particular concern even when physical manipulation of the sediment is minimized.

(The in-situ method would appear to be the better approach to measuring sediment oxygen demand since it involves less manipulation of sediments and other environmental conditions.)

TABLE 3. Comparison of TVA Laboratory SOD Rates and EPA In-situ SOD Rates in TVA Reservoirs, September 1983.

Location	TVA Lab Data		EPA In-situ Data	
	Rep #	g/m <sup>2</sup> -day	Rep #	g/m <sup>2</sup> -day
Pickwick Reservoir, Ala. (Mile 214.8)	1	1.36	1	2.23
	2	1.26	2	2.42
	Avg.	1.31	3	2.50
			Avg.	2.39
Pickwick Reservoir, Ala. (Mile 216.4)	1	1.49	1	0.96
	2	1.38	2	1.34
	Avg.	1.44	3	0.84
			4	0.77
			5	0.77
			6	0.67
		Avg.	0.89	
Guntersville Reservoir, Ala. (Brown's Creek)	1	1.22	1	5.33
	2	1.13	2	3.66
	Avg.	1.18	3	3.24
			4	3.58
			5	4.18
			6	3.26
		Avg.	3.91	
Bunkers Chapel Ala.	1	1.10	1	1.87
	2	0.78	2	1.90
	Avg.	0.94	3	2.26
			4	2.81
			5	2.88
			6	2.50
		Avg.	2.38	

## IN-SITU METHOD

321

## ACKNOWLEDGEMENTS

Authors. Philip J. Murphy and Delbert B. Hicks are Aquatic Biologists at the U.S. Environmental Protection Agency, Region IV Ecology Branch, College Station Road, Athens, GA 30613.

Credits. Special thanks are given to L.B. Tebo, Jr. for his technical advice and support in the development of SOD equipment and methodology and incorporating it into Ecology Branch programs. The assistance of Donald Lawhorn in gear preparation and the many field studies involving SOD rate determinations is also greatly appreciated, as are the contributions of Dorothy Stiber who typed this paper and many other SOD study reports.

## REFERENCES

1. Streeter, H. W. and E. B. Phelps, "A Study of the Pollution and Natural Purification of the Ohio River III. Public Health Bulletin No. 146, U.S. Public Health Service, Washington, D.C. (1925)
2. Hutchinson, G. E., A Treatise on Limnology. John Wiley and Sons, Inc. (1957).
3. Veis, G. J., Oxygen Relationships in Streams. U.S. Public Health Service. Robert A. Taft Sanitary Engineering Center, Tech. Rep. W58-2, pp. 47-61 (1985).
4. Owens, M. and R. W. Edwards, "Oxygen Studies in the R. Lark." Proc. Soc. Wat. Treat. Exam, Vol. 12, pp. 126-45 (1963).
5. Bowman, George T. and Joseph J. Delfino, "Sediment Oxygen Demand Techniques: A Review and Comparison of Laboratory and In Situ Systems." Water Research, Vol. 14, pp. 491-499 (1980).
6. Crook, G. R. and D. A. Bella, "In Situ Measurement of the Oxygen Requirements of Tidal Flat Areas." Proc. 23rd Industrial Waste Conference, Purdue University, Ind. Engineering Extension Service (1970).
7. O'Connell, R. L. and Weeks, "An In-Situ Respirometer." CBSRBP Technical Paper #6, FWPCA, Region III (1966).
8. James, A., "The Measurement of Benthic Respiration." Water Research, Vol. 8, pp. 955-959 (1974).
9. Lucas, A. M. and N. A. Thomas, "Sediment Oxygen Demand in Lake Erie's Central Basin 1970." Project Hypo., U.S.E.P.A. Technical Report T.S.-05-71-208-24, pp. 45-50 (1972).
10. Butts, T. A., "Measurement of Sediment Oxygen Demand Characteristics of the Upper Illinois Waterway." Illinois State Water Survey Report Invest. 761 1-92 (1974).

11. Boynton, W. R., W. M. Kemp, C. B. Osborne, K. R. Kaumeyer and M. C. Jenkins, "Influence of Water Circulation Rate on In-Situ Measurement of Benthic Community Respiration." *Mar. Biol. (BZRL)* Vol. 65, No. 2, pp. 185-190 (1981).
12. Whittemore, R. C., "Intefacial Velocity Effects on Measurement of Sediment Oxygen Demand." NCASI Technical Bulletin 317, New York, N.Y.. November, 1978.
13. U.S.E.P.A., Biological Field and Laboratory Methods for Measuring the Quality of Surface Waters and Effluents. Cornelius I. Weber, Ed. National Environmental Research Center, Office of Research and Development. U.S.E.P.A., Cincinnati, Ohio. EPA-670-4-73-001.
14. Edburg, Nils and Bengt V. Hofsten, "Oxygen Uptake of Bottom Sediments Studied In-Situ and in the Laboratory." *Water Research*, Vol. 7, pp. 1285-1294 (1973).
15. Edwards, R. W, and H. L. J. Rolley, "Oxygen Consumption of River Muds," *J. Ecology*, Vol. 53, No. 1, pp. 1-18 (1965).
16. Rolley, H. J. L. and M. Owens, "Oxygen Consumption Rates and Some Chemical Properties of River Muds." *Water Research*, Vol. 1, pp. 759-766 (1967).
17. Belanger, T. V., "Comparison of Benthic Oxygen Demand Techniques." Dept. of Env. Sci. and Eng., Florida Inst. Tech., Melbourne, Florida (1979).
18. Belanger, Thomas V., "Benthic Oxygen Demand in Lake Apopka, Florida." *Water Research*, Vol. 15, pp. 267-274 (1981).
19. Hopkinson, C. S., J. W. Day, Jr., and B. T. Gael, "Respiration Studies in a Louisiana Salt Marsh," *An. Cent. Science Mar. Limnol. Univ. Nat. Auton. Mex.*, Vol. 5, No. 1, pp. 225-237 (1978).
20. Smith, K. L. and J. M. Teal, "Deep-Sea Benthic Community Respiration, An In-Situ Study at 1850 Meters." *Science*, Vol. 179, pp. 282-283 (1973).



# **ATTACHMENT 2**

**Salt Creek / East Branch DuPage River  
Sediment Oxygen Demand Study  
Field Data Sheets**

# SOD Measurement Station ID: EB1

## SALT CREEK/EAST DUPAGE RIVER SEDIMENT OXYGEN DEMAND STUDY FIELD DATA SHEET

Date: 7/31/06 Personnel: McCroskey Sadony, Kressman

Location: North of St. Charles Bridge EBSC

GPS Coordinates: \_\_\_\_\_

River [width, depth, % sediment on x-s, description]: 30-40 ft width,  
Depth: 18 inches, 50% sediment in shade, rocky  
bottom

Sediment [depth, description]: 3 inches deep, grainy, small rock  
particles, fine silt, none

**DO Meter Calibration Info:**

	Meter 1	Meter 2	Meter 3
DO (mg/L)	8.09	8.16	8.25

**Photosynthesis reference and QC:**

	Time		Probe Reading		Winkler Titration	
	Start Time	End Time	DO (mg/L)	Temp (°C)	Titration Reading	DO (mg/L)
Initial	10:20 am	10:52 am	5.41	26.0	239	4.78
Light Bottle	10:10 am		5.43		275-225	4.50
Dark Bottle	10:10 am	12:04	5.54	26.6	242	4.84

Time	DO (mg/L)	Temp (°C)	Time	DO (mg/L)	Temp (°C)	DO	Temp
10:05 am	4.73	25.3		4.02	25.6	5.31	25.3
10:11 am	4.56	25.4		3.92	25.7	25.4	25.21
10:20 am	4.39	25.5		3.82	25.9	5.21	26.5
10:36 am	4.23	25.6		3.80	26.1	5.23	25.7
10:46 am	4.05	25.8		3.72	26.2	5.25	25.9
10:51 am	3.90	26.0		3.70	26.3	5.27	26.1
11:02 am	3.75	26.1		3.65	26.6	5.29	26.1
11:18 am	3.56	26.4		3.57	26.8	5.31	26.5
11:28 am	3.41	26.6		3.39	27.0	5.32	26.7
11:38 am	3.29	26.7		3.38	27.2	5.33	26.9
11:48	3.13	26.9		3.29	27.3	6.35	27.1
11:58	3.02	27.1		3.28	27.5	5.35	27.2

Signature

# SOD Measurement Station ID: EB2

## SALT CREEK/EAST DUPAGE RIVER SEDIMENT OXYGEN DEMAND STUDY FIELD DATA SHEET

Date: 7/31/06 Personnel: J. Pressman, McCracken, PES

Location: Churchill Woods Dam

GPS Coordinates: \_\_\_\_\_

River [width, depth, % sediment on x-s, description]: <sup>very</sup> Wide river above dam,  
2.5 feet deep, Shady area, 100% sediment,

Sediment [depth, description]: 1.5 feet deep, fine, silty sediment  
done

**DO Meter Calibration Info:**

	Meter 1	Meter 2	Meter 3
DO (mg/L)	6.78	7.04	7.31

**Photosynthesis reference and QC:**

	Time		Probe Reading		Winkler Titration	
	Start Time	End Time	DO (mg/L)	Temp (°C)	Titration Reading	DO (mg/L)
Initial	2:45pm		12.13	32.6	571	11.42
Light Bottle	2:45pm		11.59		628	12.56
Dark Bottle	2:45pm	4:25	11.84		526	10.52

Time	DO (mg/L)	Temp (°C)	DO (mg/L)	Temp (°C)	DO (mg/L)	Temp (°C)
2:50	11.13	32.5	10.67	32.4	11.71	33.2
3:00	10.25	32.5	9.27	32.4	12.28	33.1
3:10	9.85	32.4	8.92	32.4	12.18	33.0
3:20	9.70	32.4	8.77	32.5	12.05	33.0
3:30	9.36	32.4	8.49	32.6	11.92	33.1
3:40	9.27	32.5	7.92	32.6	11.84	33.1
3:50	8.95	32.5	7.61	32.8	11.71	33.1
4:00	8.73	32.6	7.13	32.8	11.62	33.1
4:10	8.67	32.6	7.04	32.8	11.60	33.1
4:20	8.05	32.7	6.71	32.9	11.49	33.2

#1  
DO Probe + stopper  
fell out during  
course of readings

air  
bubbles  
in tank

super saturated

Signature \_\_\_\_\_

# SOD Measurement Station ID: EB3

## SALT CREEK/EAST DUPAGE RIVER SEDIMENT OXYGEN DEMAND STUDY FIELD DATA SHEET

Date: SEP 01, 2006 (FRI) Personnel: CLB, PES

Location: Churchill Woods - EB @ Crescent Blvd - 100 yds downstream from footbridge along N bank

GPS Coordinates: \_\_\_\_\_

River [width, depth, % sediment on x-s, description]: \_\_\_\_\_

2.8'  
1.7'  
1.1'

width = wide

depth = 1.7'

% on x-s = 100%

Sediment [depth, description]: \_\_\_\_\_

depth = 1.1'

description = thick, light fluffy on top of denser sed

**DO Meter Calibration Info:**

OK	<u>25.00 ± 0.26</u>	Meter 1	Meter 2	Meter 3
	DO (mg/L)			

**Photosynthesis reference and QC:**

	Time		Probe Reading		Winkler Titration	
	Start Time	End Time	DO (mg/L)	Temp (°C)	Titrator Reading	DO (mg/L)
Initial	3:06	—	9.30	25.2	373	7.4
Light Bottle	3:09	4:56	9.16	24.5	322	6.4
Dark Bottle	3:12	4:59	7.85	24.8	393	7.8

Time	1		2		3	
	DO (mg/L)	Temp (°C)	DO (mg/L)	Temp (°C)	DO (mg/L)	Temp (°C)
3:18	7.62	24.2	7.37	25.3	8.50	24.4
3:28	7.44	24.3	7.12	25.4	8.54	24.5
3:38	7.26	24.4	6.83	25.5	8.47	24.5
3:48	7.03	24.4	6.51	25.5	8.40	24.6
3:58	6.91	24.4	6.35	25.4	8.33	24.5
4:08	6.75	24.4	6.11	25.4	8.24	24.5
4:18	6.62	24.4	5.90	25.3	8.17	24.5
4:28	6.46	24.3	5.68	25.4	8.09	24.4
4:38	6.35	24.3	5.44	25.3	8.01	24.4
4:48	6.25	24.3	5.38	25.4	7.96	24.4

Signature \_\_\_\_\_

## SOD Measurement Station ID: EB4

### SALT CREEK/EAST DUPAGE RIVER SEDIMENT OXYGEN DEMAND STUDY FIELD DATA SHEET

Date: Aug 1, 2006 Personnel: S, CLB  
 Location: EB just north of FL Rt 38 (Roosevelt Rd)

GPS Coordinates: \_\_\_\_\_

River [width, depth, % sediment on x-s, description]: 30-40 ft wide;  
reasonably steep slope to 2' deep; 12" sediment in center;  
90% sediment x-s coverage;

Sediment [depth, description]: 12" sediment in center; 1" toward banks;  
very light as whipped; fine silt;

#### DO Meter Calibration Info:

	Meter 1	Meter 2	Meter 3
DO (mg/L)	7.47	7.44	7.45

#### Photosynthesis reference and QC:

	Time		Probe Reading		Winkler Titration	
	Start Time	End Time	DO (mg/L)	Temp (°C)	Titration Reading	DO (mg/L)
Initial	9:23	—	5.77	29.8	158	3.16
Light Bottle	9:33	11:02	6.82	31.8	228	4.56
Dark Bottle	9:33	11:03	5.73	31.5	240	4.80

BLANK

Time	1		2		3	
	DO (mg/L)	Temp (°C)	DO (mg/L)	Temp (°C)	DO (mg/L)	Temp (°C)
9:30	3.55	28.8	4.46	29.2	5.76	28.8
9:40	3.34	29.1	4.16	29.5	5.16	29.1
9:50	3.26	29.3	4.05	29.6	5.13	29.2
10:00	3.15	29.5	3.84	29.8	5.12	29.4
10:10	3.05	29.7	3.71	30.0	5.07	29.6
10:20	2.93	29.9	3.54	30.2	5.07	29.8
10:30	2.83	30.1	3.41	30.4	5.05	30.0
10:40	2.70	30.4	3.21	30.7	5.03	30.3
10:50	2.59	30.6	3.06	30.9	5.03	30.6
11:00	2.51	30.8	2.92	31.1	5.01	30.8

Signature \_\_\_\_\_

# SOD Measurement Station ID: EB5

## SALT CREEK/EAST DUPAGE RIVER SEDIMENT OXYGEN DEMAND STUDY FIELD DATA SHEET

Date: 8/1/06

Personnel: PES, SM

Location: RH ~~09~~ at outflow of detention ponds

GPS Coordinates: \_\_\_\_\_

River [width, depth, % sediment on x-s, description]:  
Depth 1.7' in detention pond next to outflow.  
100% coverage.

Sediment [depth, description]:  
Depth 1.1' very fine silty clay - very soft, Chambers siccated  
quite deeply

**DO Meter Calibration Info:**

	Meter 1	Meter 2	Meter 3
DO (mg/L)	6.84	6.84	6.82

*Sediment 2" may have been 2" overflange or reduced water v*

**Photosynthesis reference and QC:**

	Time		Probe Reading		Winkler Titration	
	Start Time	End Time	DO (mg/L)	Temp (°C)	Titration Reading	DO (mg/L)
Initial			9.21	34.5	397	7.94
Light Bottle	2:05	4:00	9.19	33.9	267	5.84
Dark Bottle	2:05	4:00	8.82	33.4	229	4.58

Time	1		2		3	
	DO (mg/L)	Temp (°C)	DO (mg/L)	Temp (°C)	DO (mg/L)	Temp (°C)
2:10	6.27	32.9	6.74	33.1	8.05	33.3
2:20	5.58	33.1	5.87	33.1	7.89	33.4
2:30	5.20	33.2	5.48	33.2	7.84	33.5
2:40	4.75	33.3	5.05	33.3	7.78	33.7
2:50	4.48	33.4	4.67	33.4	7.74	33.8
2:55	<del>4.18</del> 4.18	33.5	4.44	33.5	7.59	33.9
3:10	3.85	33.7	4.02	33.7	7.51	34.0
3:20	3.67	33.9	3.70	33.8	7.44	34.2
3:30	3.39	34.0	3.29	34.0	7.38	34.3
3:40	3.17	34.0	3.24	34.0	7.29	34.4
3:50	2.97	34.1	3.00	34.2	7.24	34.4

Signature \_\_\_\_\_

## SOD Measurement Station ID: EB6

### SALT CREEK/EAST DUPAGE RIVER SEDIMENT OXYGEN DEMAND STUDY FIELD DATA SHEET

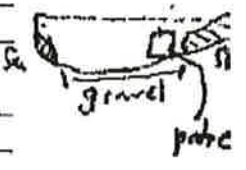
Date: 8/2/2006 Personnel: PS, SM.

Location: 300' upstream (North) of Butterfield on East branch (East side of stream)

GPS Coordinates: \_\_\_\_\_

River [width, depth, % sediment on x-s, description]: 30ft., depth 1.9', 70% gravel 30% silt  
Coarse gravel, heavily under cuts banks  
East Bank Shaded (Side in Shade)

Sediment [depth, description]: Fine silt (not clay) 2" deep.



**DO Meter Calibration Info:**

	Meter 1	Meter 2	Meter 3
DO (mg/L)	7.98	7.93	8.04

**Photosynthesis reference and QC:**

	Time		Probe Reading		Winkler Titration	
	Start Time	End Time	DO (mg/L)	Temp (°C)	Titration Reading	DO (mg/L)
Initial	9:20	10:00	5.53	26.1	212	4.24
Light Bottle	9:25	10:55	5.31	26.2	198	3.96
Dark Bottle	9:25	10:55	5.26	26.2	206	4.12

Time	1		2		3	
	DO (mg/L)	Temp (°C)	DO (mg/L)	Temp (°C)	DO (mg/L)	Temp (°C)
9:25	4.30	25.7	4.11	26.6	4.99	25.7
9:35	4.16	25.7	4.64	26.6	4.92	25.7
9:45	4.02	25.8	3.96	26.7	4.91	25.7
9:55	3.93	25.8	3.91	26.6	4.91	25.8
10:05	3.78	25.8	3.90	26.7	4.91	25.8
10:15	3.75	25.8	3.89	26.7	4.91	25.8
10:25	3.65	25.8	3.86	26.8	4.9	25.8
10:35	3.59	25.9	3.82	26.8	4.89	25.9
10:45	3.50	25.9	3.82	26.8	4.89	25.9
10:55	3.45	25.9	3.86	26.8	4.88	25.9

\_\_\_\_\_  
Signature

# SOD Measurement Station ID: EB7

## SALT CREEK/EAST DUPAGE RIVER SEDIMENT OXYGEN DEMAND STUDY FIELD DATA SHEET

Date: 8/2/2006 Personnel: PS/SM

Location: 50' South of Butterfield Road, East Branch

GPS Coordinates: \_\_\_\_\_

River [width, depth, % sediment on x-s, description]: 40' wide, 1.4' deep,  
2" of Sediment  
Area dense with aquatic plants,

Sediment [depth, description]: 2" deep, Covers 100% of bottom  
50% gravel/Sediment mix

**DO Meter Calibration Info:**

	Meter 1	Meter 2	Meter 3
DO (mg/L)	7.41	7.34	7.37

**Photosynthesis reference and QC:**

	Time		Probe Reading		Winkler Titration	
	Start Time	End Time	DO (mg/L)	Temp (°C)	Titration Reading	DO (mg/L)
Initial	12:05		7.32	28.1	2.98	5.96
Light Bottle	12:05	13:45	7.76	28.0	2.16	4.32
Dark Bottle	12:05	13:45	7.15	28.0	1.46	2.92

Time	DO (mg/L)	Temp (°C)	DO (mg/L)	Temp (°C)	DO (mg/L)	Temp (°C)
12:04	5.24	26.6	4.48	30.4	6.84	26.5
12:14	6.83	26.6	4.64	27.4	6.83	26.5
12:24	4.53	26.7	4.47	27.3	6.82	26.6
12:34	4.41	26.8	4.30	27.4	6.81	26.7
12:44	4.23	26.8	4.17	27.5	6.79	26.8
12:54	6.02	26.9	3.91	27.4	6.79	26.8
13:04	3.62	27.0	3.64	27.6	6.75	27.0
13:14	3.43	27.1	3.51	27.7	6.74	27.0
13:24	3.26	27.2	3.29	27.8	6.72	27.1
13:34	3.14	28.0	3.13	28.0	6.71	27.2
13:44	2.98	27.4	2.92	28.1	6.69	27.4

Signature



# SOD Measurement Station ID: EB8

## SALT CREEK/EAST DUPAGE RIVER SEDIMENT OXYGEN DEMAND STUDY FIELD DATA SHEET

Date: Aug 8, 2006 Personnel: CLB, SM, PES

Location: EB @ Holston Rd

\* GPS Coordinates: \_\_\_\_\_

River [width, depth, % sediment on x-s, description]: Width 35', gravel bed (sub surface sedi  
2' of water

Sediment [depth, description]: 1.2' of sediment  
fine black silty clay

### DO Meter Calibration Info:

	Meter 1	Meter 2	Meter 3
DO (mg/L)	8.88	8.81	8.88

(9:35 AM)

### Photosynthesis reference and QC:

	Time		Probe Reading		Winkler Titration	
	Start Time	End Time	DO (mg/L)	Temp (°C)	Titrator Reading	DO (mg/L)
Initial	9:40		6.96	22.9	2630	6.50
Light Bottle	9:45	11:36	7.35	23.8	"	6.45
Dark Bottle	9:45		6.87	23.4	"	6.20

10  
20  
30  
40  
50  
60  
70  
80  
90  
100  
110

	1		2		3	
Time	DO (mg/L)	Temp (°C)	DO (mg/L)	Temp (°C)	DO (mg/L)	Temp (°C)
9:42	5.80	22.9	5.10	24.0	6.04	22.9
9:52	5.75	23.0	5.00	24.0	6.14	23.0
10:02	5.68	23.1	4.76	24.2	6.10	23.1
10:12	5.51	23.2	4.67	24.2	6.08	23.1
10:22	5.41	23.3	4.45	24.3	6.04	23.2
10:32	5.40	23.4	4.26	24.4	6.01	23.3
10:42	5.36	23.4	4.09	24.4	5.98	23.4
10:52	4.40	23.5	2.32	24.5	5.14	23.4
11:02	3.19	23.5	1.61	24.5	4.09	23.4
11:12	2.94	23.6	1.71	24.5	3.38	23.5
11:22	2.94	23.6	1.50	24.6	3.07	23.5
11:32	2.85	23.7	1.65	24.6	Signature	23.6

3.07

# SOD Measurement Station ID: SC1

## SALT CREEK/EAST DUPAGE RIVER SEDIMENT OXYGEN DEMAND STUDY FIELD DATA SHEET

Date: 8.21.06 Mon Personnel: CLB, BM, SMC  
 Location: Salt Creek @ Fullerton Ave - north of bridge  
 GPS Coordinates: in unit

River [width, depth, % sediment on x-s, description]: \_\_\_\_\_  
width = 30'  
depth = 1.4'  
% sed on x - s = 30%  
 Sediment [depth, description]: \_\_\_\_\_  
depth = 1.4'  
description = silt, sand, slightly clay, dark brown, grey

**DO Meter Calibration Info:**

	Meter 1	Meter 2	Meter 3
<u>N<sub>2</sub>O</u> 7.60			
DO (mg/L)	7.60	7.58	7.60

**Photosynthesis reference and QC:**

	Time		Probe Reading		Winkler Titration	
	Start Time	End Time	DO (mg/L)	Temp (°C)	Titration Reading	DO (mg/L)
Initial			8.65	24.6		9.8
Light Bottle	1:28	3:10	8.71	24.5		-
Dark Bottle	1:28	3:10	8.48	24.3		6.0

Time	1 (*)		2		3	
	DO (mg/L)	Temp (°C)	DO (mg/L)	Temp (°C)	DO (mg/L)	Temp (°C)
<del>1:45</del>	4.14	23.6	7.08	24.5	8.04	23.7
1:55	3.90	23.7	7.03	24.6	7.99	23.8
2:05	3.75	23.8	6.94	24.7	7.94	<del>23.9</del>
2:15	3.66	23.9	6.86	24.8	7.91	24.0
2:25	3.58	24.0	6.79	25.0	7.87	24.1
2:35	3.63	24.1	6.74	25.1	7.82	24.2
2:45	3.71	24.1	6.62	25.1	7.79	24.2
2:55	3.60	24.2	6.60	25.3	7.76	24.3
3:05	3.50	24.3	6.53	25.3	7.72	24.4
3:15	3.36	24.4	6.48	25.4	7.67	24.4

\* possible pump failure #1

Signature \_\_\_\_\_

# SOD Measurement Station ID: SC2

## SALT CREEK/EAST DUPAGE RIVER SEDIMENT OXYGEN DEMAND STUDY FIELD DATA SHEET

Date: 08.21.06 Mon Personnel: CLB, BM, SMC  
 Location: North Ave @ Salt Creek - <sup>immed</sup> south of bridge along west bank  
 GPS Coordinates: in unit in center of stream

River [width, depth, % sediment on x-s, description]: \_\_\_\_\_  
width = 30'  
depth = 2'  
% sed on x-s = 60%  
 Sediment [depth, description]: \_\_\_\_\_  
depth: 0.4'  
descrip: sandy gravel

**DO Meter Calibration Info:**

<u>8.9</u>	Meter 1	Meter 2	Meter 3
DO (mg/L)	8.90	8.90	8.91

**Photosynthesis reference and QC:**

	Time		Probe Reading		Winkler Titration	
	Start Time	End Time	DO (mg/L)	Temp (°C)	Titration Reading	DO (mg/L)
Initial	8:58	<del>9:00</del>	6.99	21.6		7.2
Light Bottle	9:05	11:00	7.03	23.2		8.2
Dark Bottle	9:05	11:00	7.00	23.1		7.4

Time	1		2		3	
	DO (mg/L)	Temp (°C)	DO (mg/L)	Temp (°C)	DO (mg/L)	Temp (°C)
9:05	6.05	21.6	2.66	22.7	6.23	21.5
9:15	6.18	21.6	2.43	22.7	6.48	21.6
9:25	6.12	21.6	2.22	22.7	6.49	21.6
9:35	6.08	21.7	2.07	22.7	6.45	21.6
9:45	6.04	21.8	1.92	22.7	6.43	21.7
9:55	5.98	21.8	1.93	22.8	6.40	21.7
10:05	5.90	21.9	2.04	22.8	6.39	21.8
10:15	5.87	22.0	2.10	22.8	6.38	21.9
10:25	5.83	22.0	2.10	23.0	6.34	21.9
10:35	5.80	22.1	2.05	23.1	6.35	22.0
10:45	5.75	22.2	2.07	23.2	6.31	22.1

Signature

rechecked calibration  
and at 25.1°C = 8.35 so DK

# SOD Measurement Station ID: SC3

## SALT CREEK/EAST DUPAGE RIVER SEDIMENT OXYGEN DEMAND STUDY FIELD DATA SHEET

Date: 08.17.06 TH

Personnel: CLB, PES

Location: Salt Creek, Butterfield Rd between 2 bridges along E. BANK

GPS Coordinates: \_\_\_\_\_

River [width, depth, % sediment on x-s, description]: 50% silt  
65' wide 50% leaves, shells, weeds, organic mat  
1.9' deep at probe small stones/rocks/pedals

Sediment [depth, description]: fine black slightly clay-like upon squishing  
deep = 1.1' dark brown

**DO Meter Calibration Info:**

	Meter 1	Meter 2	Meter 3
DO (mg/L) <del>20</del>	8.13	8.16	8.40

**Photosynthesis reference and QC:**

	Time		Probe Reading		Winkler Titration	
	Start Time	End Time	DO (mg/L)	Temp (°C)	Titration Reading	DO (mg/L)
Initial	12:17	—	8.39	24.3		6.4
Light Bottle	12:21	2:05	8.10	25.4		7.0
Dark Bottle	12:21	2:07	8.10	25.1		6.9

Time	1		2		3	
	DO (mg/L)	Temp (°C)	DO (mg/L)	Temp (°C)	DO (mg/L)	Temp (°C)
12:27	7.15	24.1	6.24	24.5	7.95	24.0
12:37	7.19	24.0	6.15	24.7	8.09	24.1
12:47	7.02	24.1	6.08	24.8	8.09	24.1
12:57	6.85	24.2	6.00	24.9	8.04	24.2
13:07	6.71	24.3	5.88	25.0	8.02	24.3
13:17	6.54	24.4	5.76	25.1	8.00	24.4
13:27	6.39	24.5	5.75	25.3	7.96	24.5
13:37	6.20	24.6	5.58	25.4	7.92	24.6
13:47	6.06	24.7	5.53	25.5	7.90	24.6
13:57	5.91	24.8	5.44	25.5	7.85	24.7

Signature \_\_\_\_\_

# SOD Measurement Station ID: SC4

## SALT CREEK/EAST DUPAGE RIVER SEDIMENT OXYGEN DEMAND STUDY FIELD DATA SHEET

Date: 8.17.

Personnel: CLB, SMc, PES

Location: ~ 200' upstream of 22<sup>nd</sup> Street on Salt Creek - EAST BANK

LEAPS Coordinates: in unit

River [width, depth, % sediment on x-s, description]: 25' sand on x-s = 100%  
35' wide;  
water depth = 1.4'

Sediment [depth, description]:  
sand depth = 1.8'  
organic matter present in a fine black silt; non-cherry  
(leaf litter)

DO Meter Calibration Info:

	Meter 1	Meter 2	Meter 3
DO (mg/L)	9.98	9.70	9.86

Photosynthesis reference and QC:

	Time		Probe Reading		Winkler Titration	
	Start Time	End Time	DO (mg/L)	Temp (°C)	Titration Reading	DO (mg/L)
Initial	8:45	—	5.96	22.1		5.0
Light Bottle	8:55	10:45	6.05	23.4		4.7
Dark Bottle	8:55	10:45	6.26	23.2		4.4

CONTROL

Time	1		2		3	
	DO (mg/L)	Temp (°C)	DO (mg/L)	Temp (°C)	DO (mg/L)	Temp (°C)
8:55	4.34	22.3	4.30	23.5	5.38	22.2
9:05	5.17	22.3	4.55	23.5	5.59	22.2
9:15	5.10	22.4	4.43	23.6	5.57	22.3
9:25	5.08	22.5	4.32	23.6	5.57	22.3
9:35	5.04	22.5	4.23	23.7	5.57	22.3
9:45	5.00	22.6	4.18	23.7	5.54	22.4
9:55	4.98	22.7	4.13	23.8	5.53	22.5
10:05	4.95	22.8	4.09	23.9	5.52	22.6
10:15	4.90	22.8	3.96	24.0	5.49	22.6
10:25	4.89	22.9	3.93	24.0	5.48	22.7
10:35	4.85	23.0	3.85	24.1	5.45	22.7

Signature

# SOD Measurement Station ID: SC5

## SALT CREEK/EAST DUPAGE RIVER SEDIMENT OXYGEN DEMAND STUDY FIELD DATA SHEET

Date: 8.16.06 WED

Personnel: CLB, SM

Location: 200 feet upstream of OB Dam along east bank - 31st Street

GPS Coordinates: in unit

River [width], depth, % sediment on x-s, description: 30' to soft silty non clay  
water depth = 2'  
width = 100'  
10% clay particles

✓ Sediment [depth, description]:  
fine dark silt; non-clay  
sediment depth = 3' (feet)

**DO Meter Calibration Info:**

	Meter 1	Meter 2	Meter 3
DO (mg/L)	7.36	7.26	7.33

**Photosynthesis reference and QC:**

	Time		Probe Reading		Winkler Titration	
	Start Time	End Time	DO (mg/L)	Temp (°C)	Titration Reading	DO (mg/L)
Initial	2:04	—	6.47	24.9		5.5
Light Bottle	2:06	3:25	6.00	25.2		5.0
Dark Bottle	2:06	3:25	6.24	24.5		4.9

Time	1		2		3	
	DO (mg/L)	Temp (°C)	DO (mg/L)	Temp (°C)	DO (mg/L)	Temp (°C)
2:15	5.12	24.3	4.28	24.7	6.28	24.3
2:25	5.16	24.1	4.24	24.7	6.19	24.2
2:35	5.02	23.9	4.13	24.6	6.16	24.1
2:45	4.88	23.9	3.96	24.6	6.13	24.1
2:55	4.82	23.8	3.86	24.6	6.09	24.1
3:05	4.72	23.8	3.85	24.6	6.07	24.1
3:15	4.59	23.8	3.70	24.6	6.02	24.1
3:25	4.54	23.8	3.65	24.6	5.99	24.1
3:35	4.49	23.8	3.54	24.5	5.97	24.0
3:45	4.40	23.9	3.50	24.7	5.95	24.0

\_\_\_\_\_  
Signature

# SOD Measurement Station ID: SC6

## SALT CREEK/EAST DUPAGE RIVER SEDIMENT OXYGEN DEMAND STUDY FIELD DATA SHEET

Date: 8.16.06 WED Personnel: CLB, PES, SMC, Brian Metzke  
 Location: bridge @ Fullersburg Woods' (@ monitoring site)  
 GPS Coordinates: in unit  
 River [width, depth, % sediment on x-s, description]: 80' wide / 1.6' deep at probe; 5' deep at center; 10% silt on x-s; small rocks w/ minimal gravel, sand  
 Sediment [depth, description]: 1.6' water 1.6' deep ~~1.6' deep~~ light, fluffy over rock

**DO Meter Calibration Info:**

	Meter 1	Meter 2	Meter 3
DO (mg/L)	8.62	8.63	8.68

**Photosynthesis reference and QC:**

	Time		Probe Reading		Winkler Titration	
	Start Time	End Time	DO (mg/L)	Temp (°C)	Titration Reading	DO (mg/L)
Initial	9:10	—	6.19	24.0		5.0
Light Bottle	9:15	11:04	6.09	24.7		5.4
Dark Bottle	9:15	11:06	6.13	24.4		5.2

CONTROL

Time	1		2		3	
	DO (mg/L)	Temp (°C)	DO (mg/L)	Temp (°C)	DO (mg/L)	Temp (°C)
9:10	5.34	22.9	5.08	24.0	5.58	22.8
9:20	5.37	23.1	4.98	24.1	5.91	22.9
9:30	5.24	23.2	5.28	24.3	5.89	23.1
9:40	5.14	23.3	4.91	24.3	5.88	23.2
9:50	5.01	23.4	4.81	24.4	5.87	23.3
10:00	4.84	23.5	4.71	24.5	5.86	23.4
10:10	4.72	23.7	4.62	24.7	5.85	23.6
10:20	4.61	23.8	4.49	24.8	5.83	23.7
10:30	4.50	24.0	4.39	24.9	5.82	23.9
10:40	4.39	24.1	4.30	25.0	5.80	24.1
10:50	4.28	24.2	4.20	25.2	5.79	24.2
11:00	—	—	4.08	25.3	Signature	—

# SOD Measurement Station ID: SC7

## SALT CREEK/EAST DUPAGE RIVER SEDIMENT OXYGEN DEMAND STUDY FIELD DATA SHEET

Date: AUG 8, 2006 Personnel: CLB, SM, PES

Location: SALT CREEK @ GRAVE MILL DAM

GPS Coordinates: \_\_\_\_\_

River [width, depth, % sediment on x-s, description]: impoundment behind dam  
up approx 100' at widest; 1.6' depth of water at #1; ~~2.6' depth of water at #2~~  
2.6' depth of H<sub>2</sub>O at #2;

Sediment [depth, description]: 8' of sediment at #1 (stiffer clay-like sed  
~~1.9' of sediment at #2~~ 1.9' of " " #2 (light, fluffy layer on to

### DO Meter Calibration Info:

	Meter 1	Meter 2	Meter 3
DO (mg/L)	8.19	8.17	8.27
	(25.5°C)	(26.5°C)	(25.5°C)

### Photosynthesis reference and QC:

	Time		Probe Reading		Winkler Titration	
	Start Time	End Time	DO (mg/L)	Temp (°C)	Titration Reading	DO (mg/L)
Initial	3:14 PM	—	7.42	26.0	Dupage Co	4.95
Light Bottle	4:55 PM	5:00 PM	7.58	24.6	"	4.72
Dark Bottle	4:55 PM	5:00 PM	6.02	25.3	"	3.64

	1		2		3	
Time	DO (mg/L)	Temp (°C)	DO (mg/L)	Temp (°C)	DO (mg/L)	Temp (°C)
	4.02	26.0	3.75	26.8	5.73	26.0
10 15:29	3.98	26.0	4.04	26.9	6.74	26.0
20 15:39	3.94	26.0	4.02	26.9	6.70	26.0
30 15:49	3.81	26.0	3.84	26.9	6.80	26.0
40 15:59	3.67	26.0	3.67	27.0	6.74	26.0
50 16:09	3.56	26.1	3.55	27.0	6.70	26.1
60 16:19	3.44	26.1	3.41	27.0	6.65	26.1
70 16:29	3.41	26.1	3.31	27.0	6.62	26.1
80 16:39	3.32	26.1	3.12	27.0	6.57	26.1
90 16:49	3.20	26.1	2.97	27.0	6.53	26.1

\_\_\_\_\_  
Signature



# SOD Measurement Station ID: SC8

1 & 2 s/b steep decline

1  
2.7  
1.7  
3.4

## SALT CREEK/EAST DUPAGE RIVER SEDIMENT OXYGEN DEMAND STUDY FIELD DATA SHEET

Date: SEP 01, 2006 (FRI) Personnel: CLB, PES, SMC  
 Location: SALT CREEK @ WOLF RD - v.pstream ~ 70' - midstream

GPS Coordinates: \_\_\_\_\_

River [width, depth, % sediment on x-s, description]: \_\_\_\_\_  
45' wide no sed on x-s =  
2.7' water depth description =

Sediment [depth, description]: \_\_\_\_\_  
7' sed depth  
description = coarse grained silt - no clay

**DO Meter Calibration Info:**

	Meter 1	Meter 2	Meter 3
DO (mg/L)	8.64	8.77	8.97

**Photosynthesis reference and QC:**

	Time		Probe Reading		Winkler Titration	
	Start Time	End Time	DO (mg/L)	Temp (°C)	Titration Reading	DO (mg/L)
Initial	10:40	/	7.58	21.4		6.9
Light Bottle	10:50	12:30	7.20	22.2		6.9
Dark Bottle	10:50	12:32	7.28	22.0		6.6

BLANK

Time	1		2		3	
	DO (mg/L)	Temp (°C)	DO (mg/L)	Temp (°C)	DO (mg/L)	Temp (°C)
10:50	6.40	21.8	6.60	23.0	6.66	21.8
11:00	6.35	21.8	6.64	23.0	6.43	21.8
11:10	6.21	21.8	6.63	23.0	6.25	21.8
11:20	6.09	21.9	6.60	23.0	6.04	21.8
11:30	5.97	21.9	6.57	23.1	5.84	21.9
11:40	5.88	21.9	6.53	23.1	5.68	21.9
11:50	5.81	22.0	6.54	23.2	5.48	21.9
12:00	5.74	22.0	6.50	23.2	5.32	22.0
12:10	5.65	22.1	6.49	23.3	5.15	22.0
12:20	5.59	22.1	6.46	23.3	4.98	22.1

\_\_\_\_\_  
Signature

**SALT CREEK / DUPAGE RIVER WORK GROUP**

**STREAM DISSOLVED OXYGEN IMPROVEMENT  
FEASIBILITY STUDY  
FOR  
SALT CREEK AND EAST BRANCH OF THE  
DUPAGE RIVER**

---



**DATA REPORT**

**2007 SOD MEASUREMENT SURVEY  
SALT CREEK**

**OCTOBER 18, 2007**

Prepared by:



HDR Engineering, Inc.  
8550 W. Bryn Mawr Ave.  
Suite 900  
Chicago, IL 606031  
Job No. 44054

In Association with:



## TABLE OF CONTENTS

1.0 OBJECTIVE ..... 1

2.0 METHOD ..... 1

    2.1 Quality Control ..... 2

3.0 SAMPLING STATIONS ..... 2

4.0 FIELD MEASUREMENTS..... 3

5.0 DATA ANALYSIS..... 3

6.0 CONCLUSIONS..... 4

ATTACHMENT 1: MURPHY AND HICKS (1986)

ATTACHMENT 2: FIELD DATA SHEETS

## LIST OF TABLES

TABLE 1: SEDIMENT OXYGEN DEMAND (SOD) SURVEY LOCATIONS .....4

TABLE 2 TO TABLE 13: SOD MEASUREMENT STATIONS A TO L .....4

TABLE 14: SUMMARY OF IN-SITU SOD..... 4

## LIST OF FIGURES

FIGURE 1: IN-SITU SOD MEASUREMENT CHAMBER.....4

FIGURE 2: DEPLOYMENT OF SOD MEASUREMENT CHAMBERS.....4

FIGURE 3: 2007 SOD SURVEY LOCATIONS IN SALT CREEK .....4

FIGURE 4 TO FIGURE 15: DO VS. TIME FOR SOD STATIONS A TO L.....4

FIGURE 16: COMPARISON OF 20<sup>0</sup>C-TEMPERATURE CORRECTED SOD IN SALT CREEK  
(2007 VS. 2006 SURVEYS) .....4

## **1.0 Objective**

The purpose of this field survey was to supplement the sediment oxygen demand (SOD) data collected in 2006 which provided independent estimates of the SOD that were being modeled for dissolved oxygen in the Salt Creek as part of the Stream Dissolved Oxygen Improvement Feasibility Study for Salt Creek and East Branch of the DuPage River. It was substantiated, during the modeling analysis of Salt Creek stream DO improvement alternatives, that more SOD data in the vicinity of dams were needed to better understand the effects of dam removals. The survey was conducted spanning from July 24 to August 1, 2007 at SOD stations upstream and downstream of each of three dams in Salt Creek: Oak Meadows Golf Course Dam, Old Oak Brook Dam and Graue Mill (Fullersburg) Dam. The field surveys were performed concurrently with the continuous DO monitoring coordinated by the Conservation Foundation. As water temperature affects SOD, the SOD survey period was selected during high water temperatures to be consistent with the 2006 SOD survey and the modeling evaluations of the TMDL study of Salt Creek (approximately 76 °F or 24.4 °C).

## **2.0 Method**

The in-situ method, which by name means the measurements are made in the native location rather than in a laboratory, was employed (Murphy and Hicks 1986, refer to Attachment 1 of this report). SOD measurement chambers designed by EPA Region 4 were used in conjunction with circulating water pumps and DO probes as described in Murphy and Hicks 1986. See Figure 1 for a diagram of In-Situ SOD Measurement Chamber. Two SOD chambers were placed in contact with the bottom sediments to measure the total DO depletion rate. A “blank” chamber that is enclosed at the bottom was used to measure the DO depletion attributable to the water processes, which are the biochemical oxygen demand (BOD) exertion and biotic respiration. In general, the chambers, which are opaque, were not placed within the photic zone where photosynthesis occurred. Light and dark BOD bottles were also deployed as a backup to the “blank” chamber and to measure photosynthetic effects, if any. The SOD rate is then calculated using the following equation:

$$\text{SOD} = (V/A) * (b_1 - b_2) / 1000$$

where SOD = sediment oxygen demand rate (g/m<sup>2</sup>/day)

b<sub>1</sub> = rate of change of DO concentration in the SOD chamber (mg/L/d)

b<sub>2</sub> = rate of change of DO concentration in the “blank” chamber (mg/L/d)

V = volume of chamber (L)

A = area of chamber (m<sup>2</sup>)

The three chambers were transported by boat (see Figure 2) to the designated SOD station for deployment by the sampling crew. Water depth recorded at the stations varied between 0.9 ft and 2.5 ft. While the chamber was being lowered to the bottom, water and trapped air was vented from the open ports on the top of the chambers. Ambient bottom water was ultimately enclosed in the chambers for the SOD measurements. The enclosed chambers were left for a minimum of

15 minutes while any resuspended sediment settled to the bottom before the DO measurements began. DO and temperature in each of the three chambers were measured every ten minutes for duration of at least 1.5 hours. The DO meter/probes used with the SOD chambers were YSI models 550 and Hach HQ40D with LDO.

## **2.1 Quality Control**

DO probes utilized in the two test chambers were of a newer design than those used in 2006, called luminescence dissolved oxygen (LDO). These probes use an entirely different method of measuring DO than the membrane type probes, are very stable, and require calibration approximately once a year. The probes were initially calibrated using an air saturated water sample. In the field, a sample of air saturated DI water was measured with the LDO probe and the YSI meter was calibrated against this reading. DO readings on the three DO meters/probes at each sampling station were checked by the field crew for agreement within 0.5 mg/L. The determination of SOD is derived from the relative changes in DO and not the absolute value, nonetheless, the accuracy of the LDO probes was consistent with saturated values read from a table.

DO meters/probes were calibrated using the normal air calibration procedure. DO readings on the three DO meters/probes at each sampling station were checked by the field crew for agreement within 0.5 mg/L. In addition, a comparative calibration was generated using Winkler titration and DO probe readings of a de-ionized water sample. The initial and final DO in the light and dark bottles were measured by the YSI DO probe (referred to as Probe 3) as the Hach probes have a large diameter that would not fit in the BOD bottle.

## **3.0 Sampling Stations**

The bottom substrate composed of fine grained sediments (clay, silt and sand) are conducive to measuring SOD; coarse materials (gravel, cobbles and boulders) are not because it is difficult to seal the bottom of the chamber. High SOD rate is associated generally with a high organic content of the sediment. Slow moving reaches of the river are areas where fine-grained, organic sediments are likely to be found. The impoundments and pools formed by dams and other obstructions (e.g., debris) were identified by the reconnaissance survey (Task 1) and the helicopter fly-over DVD. The total of 12 sampling stations was designated in the vicinity of three dams in Salt Creek for in-situ SOD measurement. A set of two stations in the upstream impoundment and two stations downstream of each dam were selected as shown in Figure 3. The second station downstream of the Old Oak Brook dam (Station H) is actually located in the impoundment of the Graue Mill (Fullersberg) dam; hence there are three stations in this impoundment. Table 1 lists sampling locations (A to L stations), descriptions and river miles in Salt Creek. When the field crews arrived at each station, the river bottom was viewed or probed to estimate the percent bottom coverage of fine-grained sediment. The width and depth of the river were also measured and recorded. The fine-grained sediment area was identified as a suitable location for deployment of SOD measurement chambers.

#### **4.0 Field Measurements**

As stated previously, elevated water temperature was preferred for these measurements to reduce the modeling uncertainty associated with applying a temperature adjustment coefficient based on the literature. Field measurements were performed on five days during a period of July 24 to August 1, 2007, when there was no precipitation on that day, and the preceding day. On each day of the field survey, SOD was measured at two to three stations. Water temperature from all 12 stations range from 23.3 °C to 28.8 °C with an average of 25.1 °C. Tables 2 through 13 present raw data taken by the field crew during the 2007 SOD surveys. Water temperature from 8 stations in Salt Creek during 2006 SOD surveys ranged from 21.5 °C to 27.0 °C with an average of 23.9 °C.

#### **5.0 Data Analysis**

All data recorded in the field were key-entered into Excel for analysis (See Tables 2 through 13) and graphical presentation. The field data sheets are included as Attachment 2 to this report. DO in each of the two replicate chambers and one blank chamber were plotted against time and the data were analyzed by regression analysis to determine the “best-fit” linear equation. The measured data and the slopes are presented graphically for each set of measurements in Figures 4 through 15. Table 14 presents a summary of the calculated SOD of all 12 survey stations in Salt Creek.

In general, the time series of DO data follow linear trends and the regression analyses resulted in highly correlated sets of data with r-squared<sup>1</sup> values greater than 0.90. The DO readings for the blank probe at Station J (Figure 13), which showed some initial fluctuation in DO between 2:54 PM and 3:44 PM due to malfunction of the SOD chamber set-up. Therefore, the data collected prior to 3:44 PM at this station were eliminated in the analyses of the DO uptake rate.

The measurements of DO change in the dark bottles are generally consistent with the DO change in the blank SOD chamber. This is expected because the same biochemical processes are occurring in both containers; however, the surface area to volume ratios are different and this may account for the observed differences.

Differences between the two SOD measurements at a given station varied. Large differences may indicate that the sediment composition varies spatially at that station, whereas small differences indicate a relatively uniform sediment composition. An average of the two SOD measurements is reported in Table 14.

The conventional way of reporting SOD data is at a base water temperature of 20 °C. The Arrhenius temperature adjustment equation was used to convert SOD rates from the ambient temperature to 20 °C.

$$\text{SOD}(t) = \text{SOD}(20) * \Theta^{(T-20)}$$

---

<sup>1</sup> r is defined statistically as the correlation coefficient; r-squared is simply r<sup>2</sup>.

$$\Rightarrow \text{SOD}(20) = \text{SOD}(t) / \Theta^{(T-20)}$$

where  $\text{SOD}(t)$  = SOD at temperature T

$\text{SOD}(20)$  = SOD at 20 °C

$\Theta$  = temperature correction coefficient

A typical  $\Theta$  value for SOD is 1.08, which means there is an 8% change in SOD for a 1 °C change in temperature. Similarly, a 10 °C lower temperature (than 20 °C) yields an SOD rate that is 46% that of the base (20 °C) rate. Temperature adjusted to 20 °C for all stations are also found in Table 14. The average SOD upstream of each dam is higher than the average SOD downstream of the dam, or the single measurement in the case of the Old Oak Brook dam where there is a single downstream measurement (See Table 15).

## **6.0 Conclusions**

The SOD measured at ambient temperature in Salt Creek (SC) ranged from a minimum of 0.28 g/m<sup>2</sup>/day to a maximum of 4.10 g/m<sup>2</sup>/day. The highest SOD was observed in the impoundment upstream of Graue Mill (Fullersburg) Dam. Station-averaged 20 °C-temperature adjusted SOD was in the range of 0.19 to 2.70 g/m<sup>2</sup>/day. Figure 16 presents comparisons of the SOD results during the 2006 and 2007 surveys. The 2007 SOD rates are similar to the 2006 SOD rates in the impoundments of the Old Oak Brook and Graue Mill dams. The SOD rates adjusted to the model predicted temperature by the QUAL2K model of Salt Creek during the calibration period (8/13/06 to 8/17/06) are shown along with the 2006 and 2007 data in Figure 17. The 2007 SOD rates are lower than the model SOD data in the impoundment of the Oak Meadow golf course dam, where there were no SOD measurements taken in 2006. The model parameters for this reach will be adjusted based on the results of this field study.

The results of the 2007 SOD survey will be used to supplement the 2006 data and refine the current SOD parameters in the model.

Figure 4: DO VS. Time  
In-Situ SOD Survey - Station A

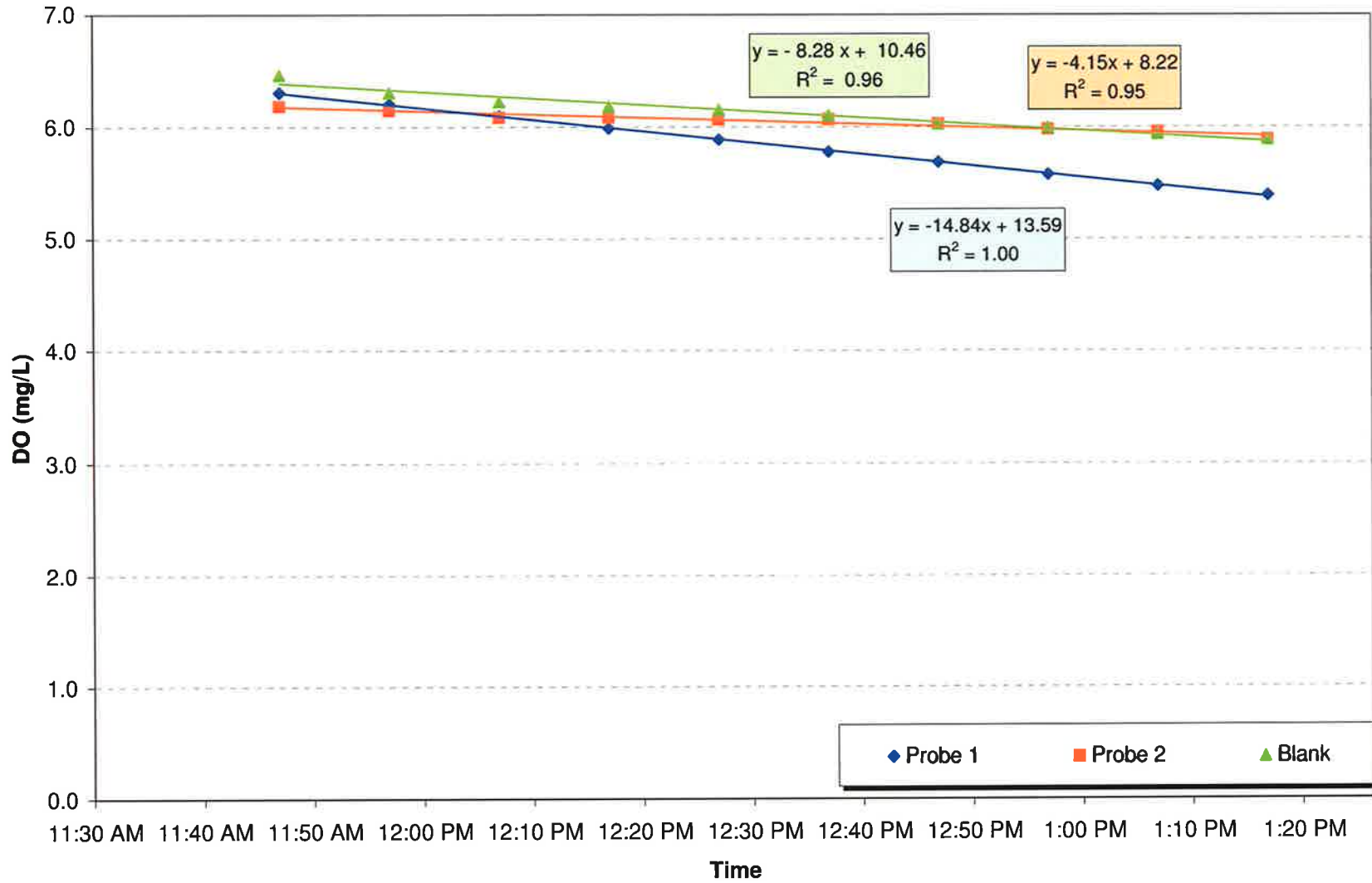




Figure 5: DO VS. Time  
In-Situ SOD Survey - Station B

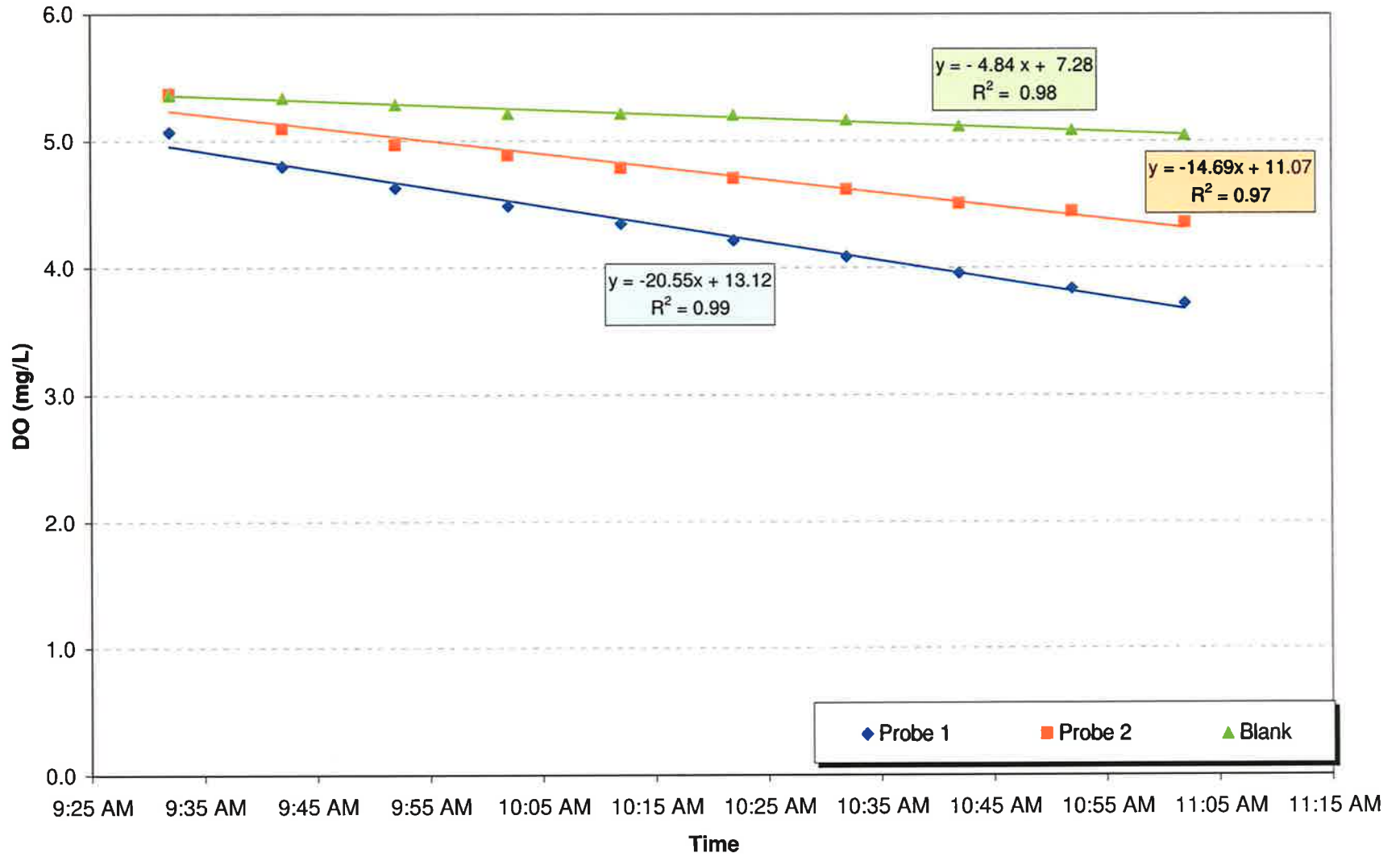


Figure 6: DO VS. Time  
In-Situ SOD Survey - Station C

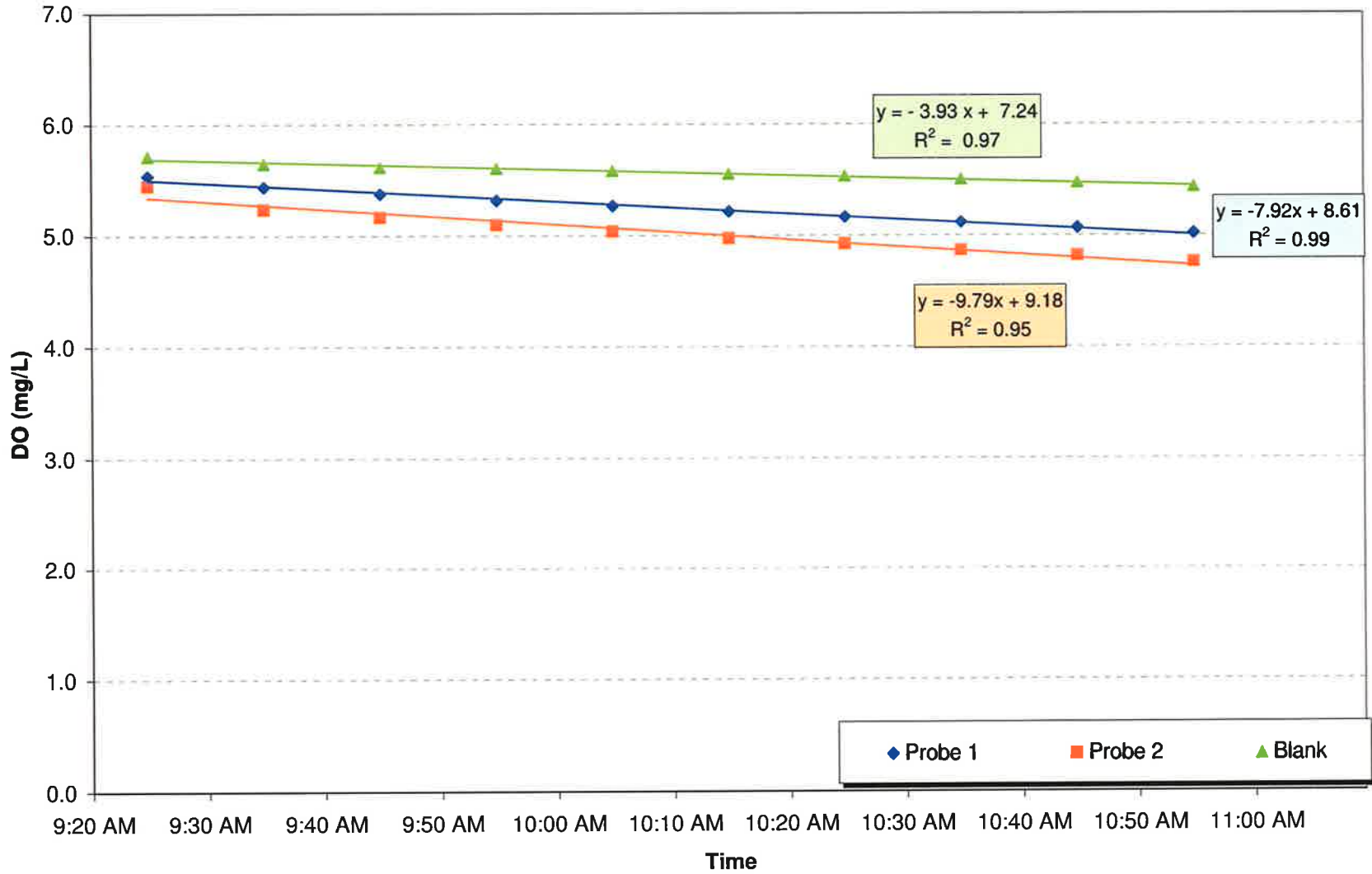


Figure 7: DO VS. Time  
In-Situ SOD Survey - Station D

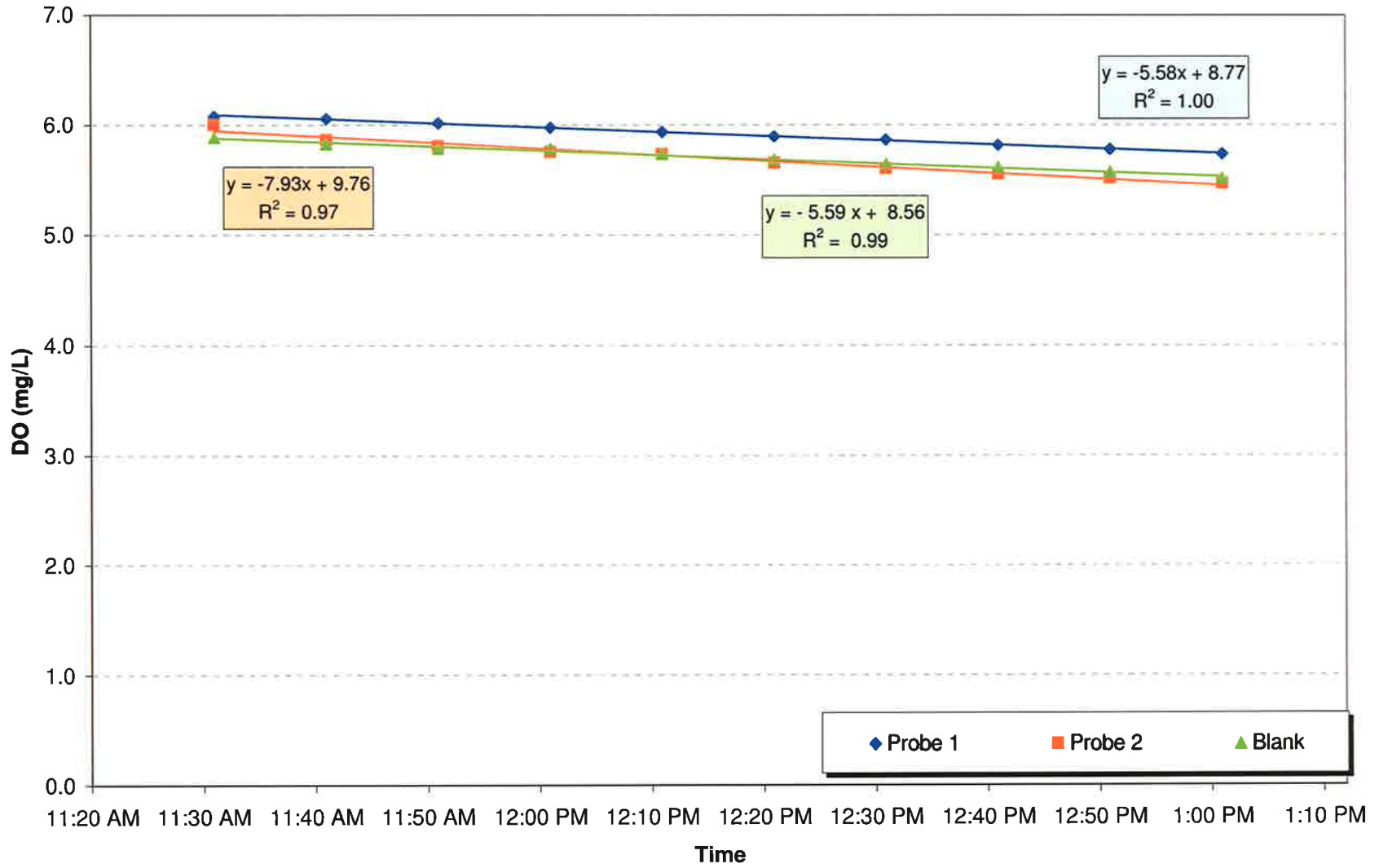


Figure 8: DO VS. Time  
In-Situ SOD Survey - Station E

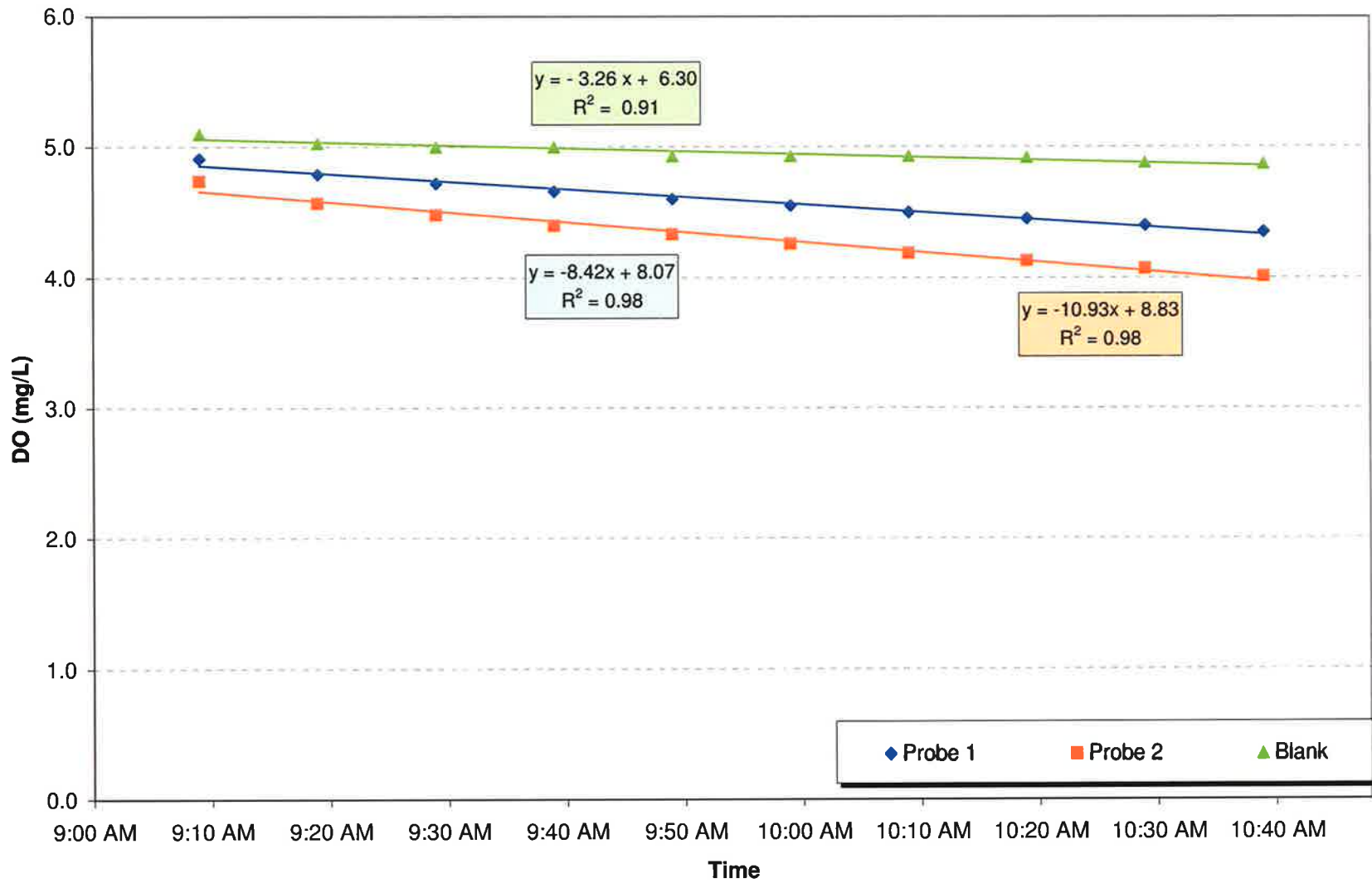


Figure 9: DO VS. Time  
In-Situ SOD Survey - Station F

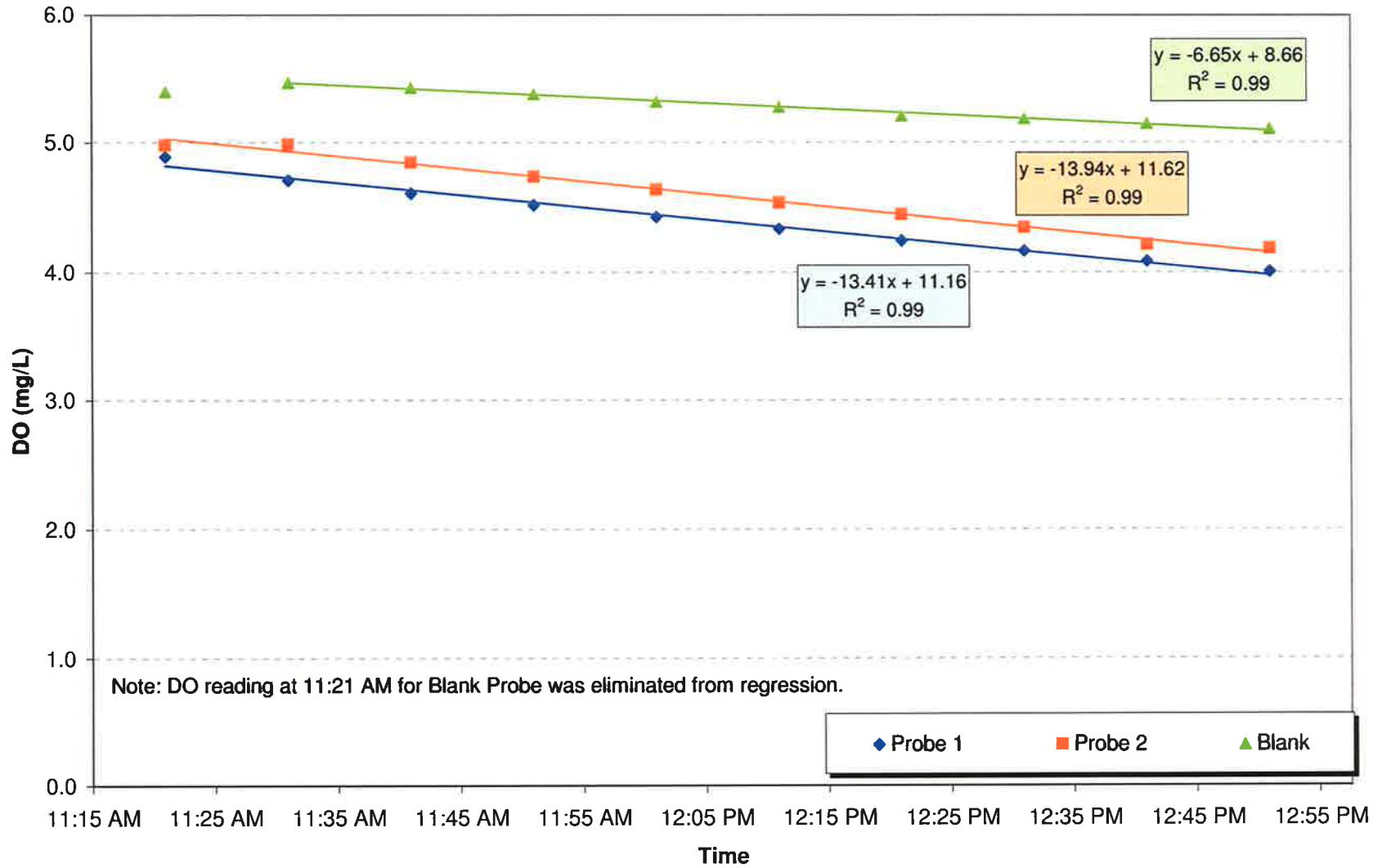


Figure 10: DO VS. Time  
In-Situ SOD Survey - Station G

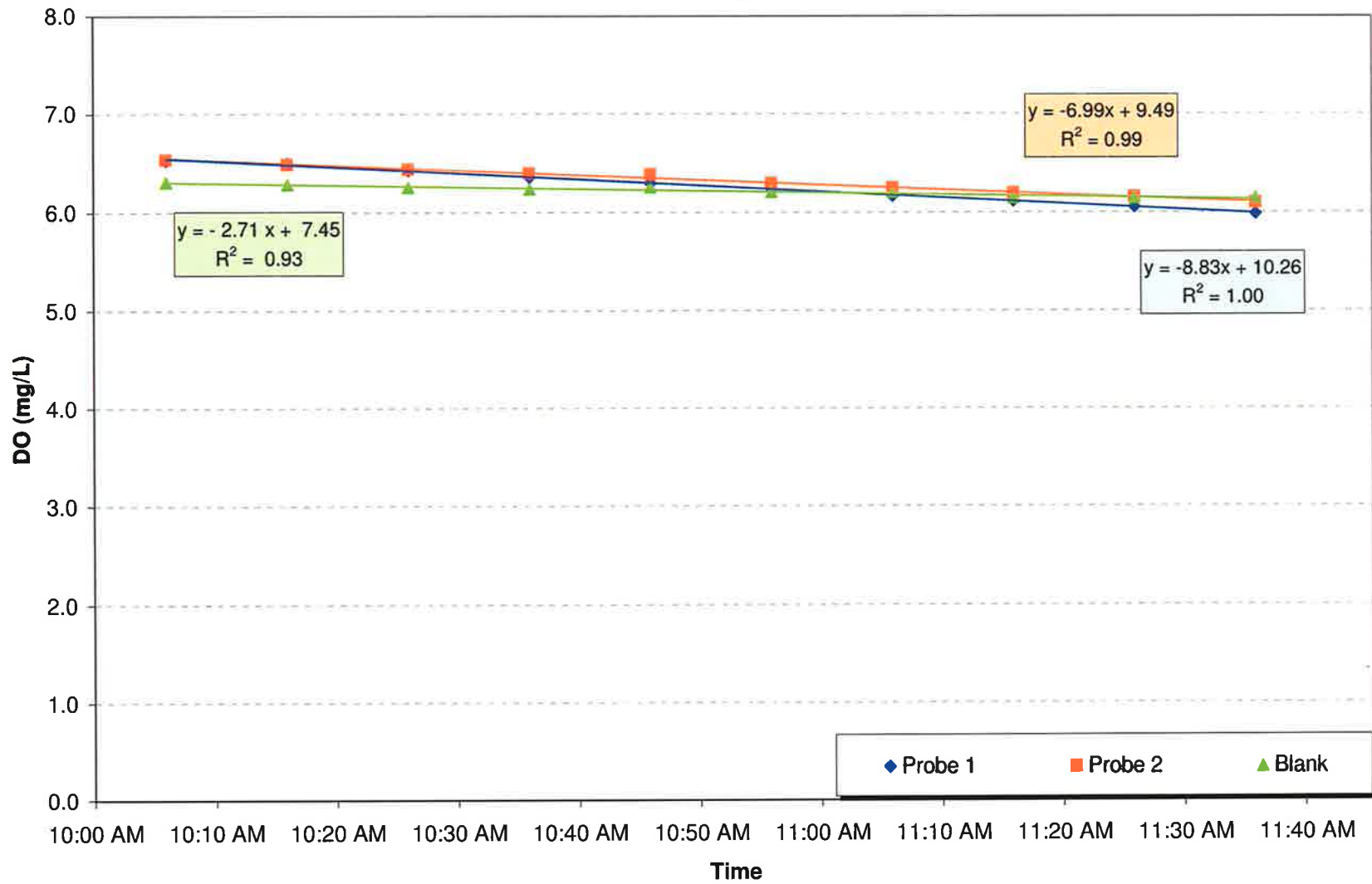


Figure 11: DO VS. Time  
In-Situ SOD Survey - Station H

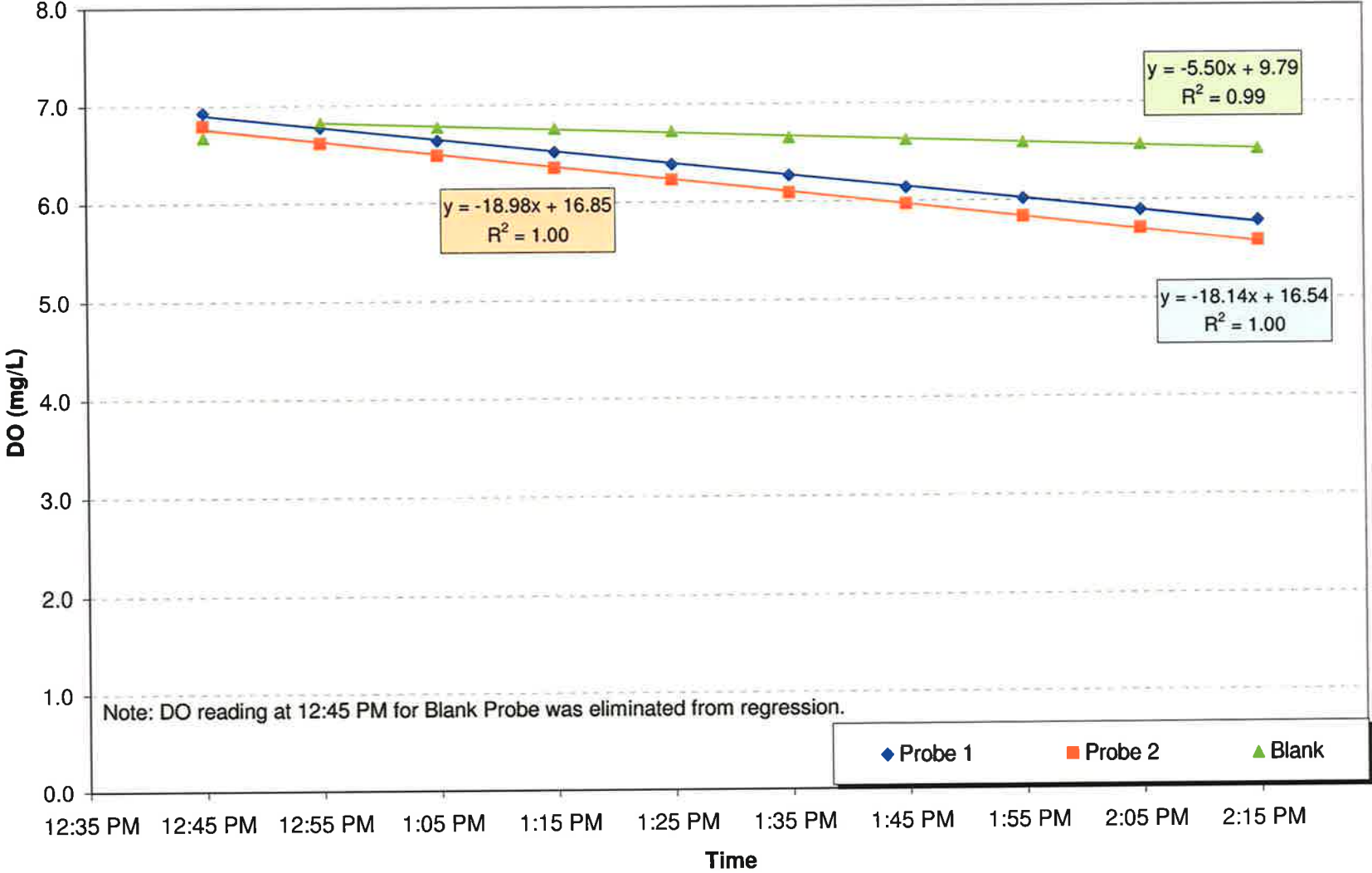


Figure 12: DO VS. Time  
In-Situ SOD Survey - Station I

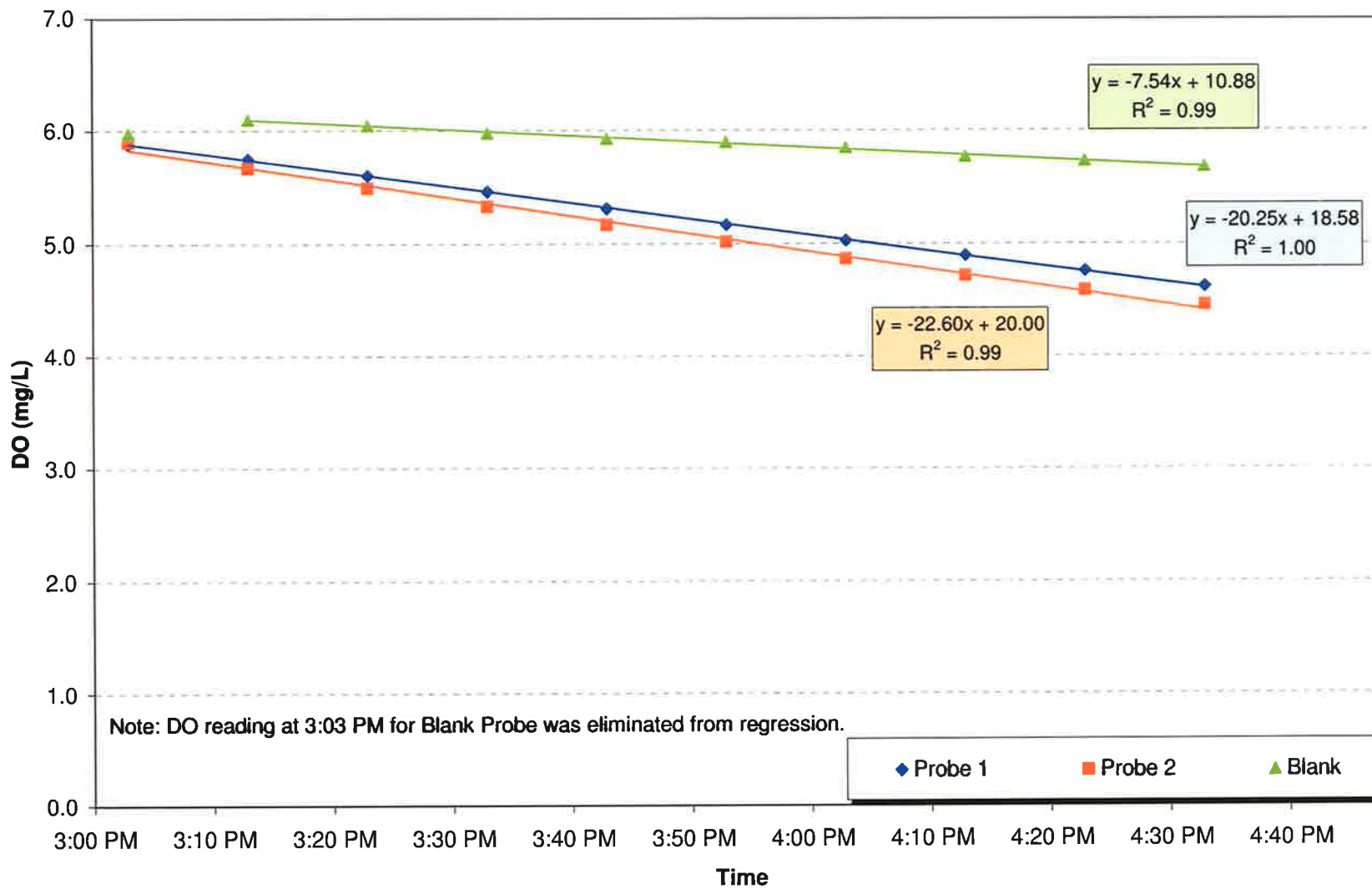




Figure 13: DO VS. Time  
In-Situ SOD Survey - Station J

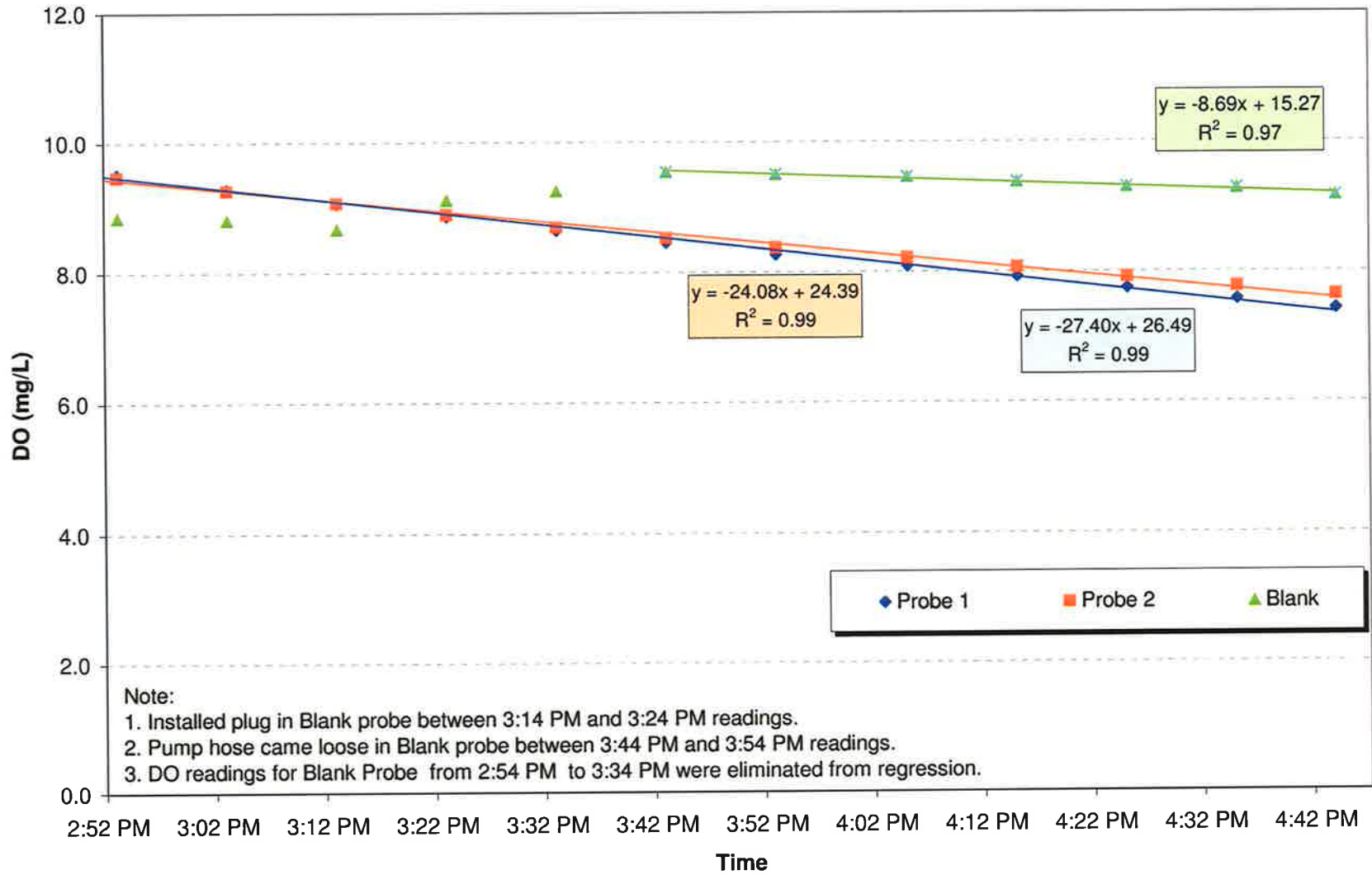


Figure 14: DO VS. Time  
In-Situ SOD Survey - Station K

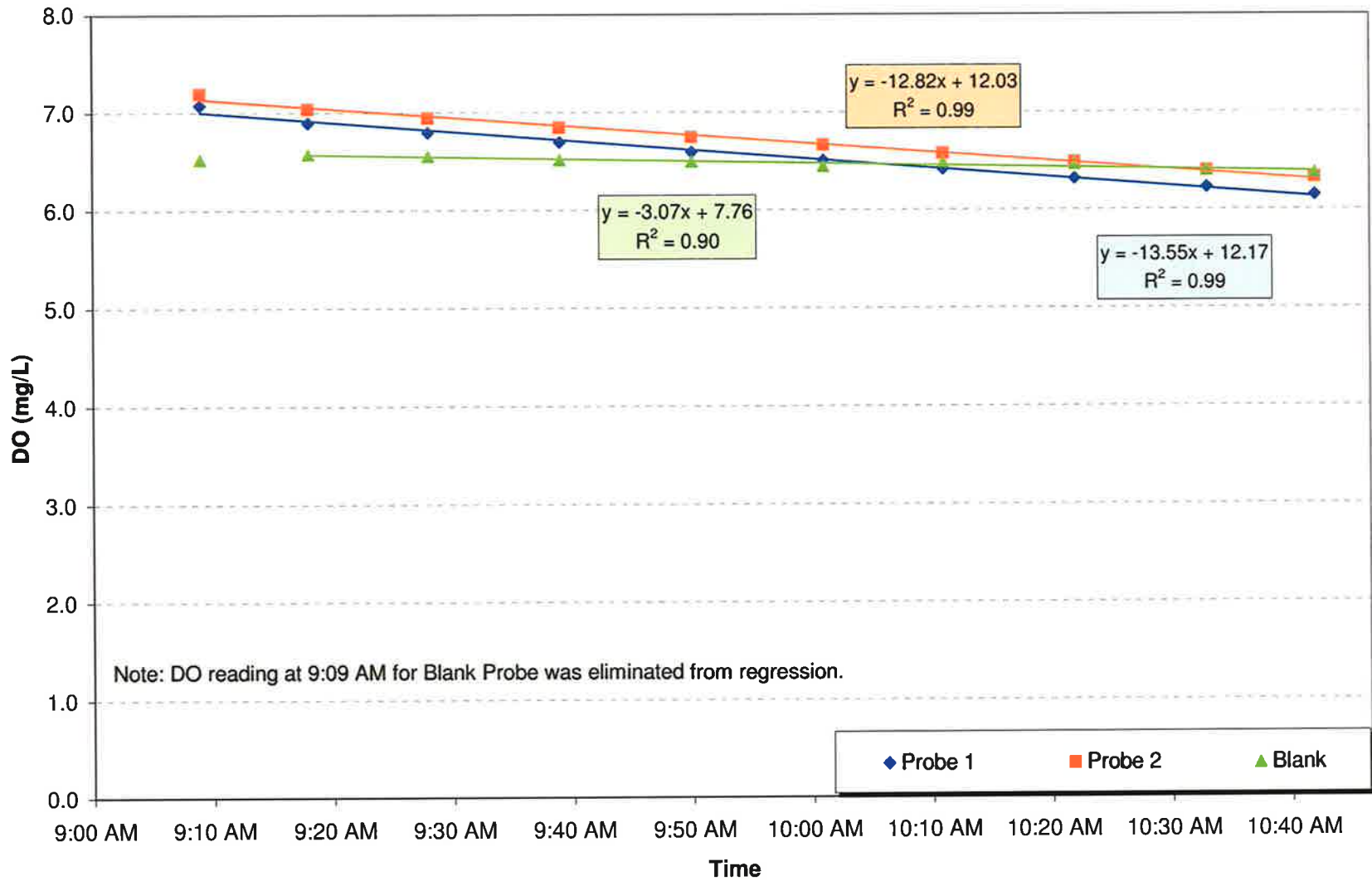
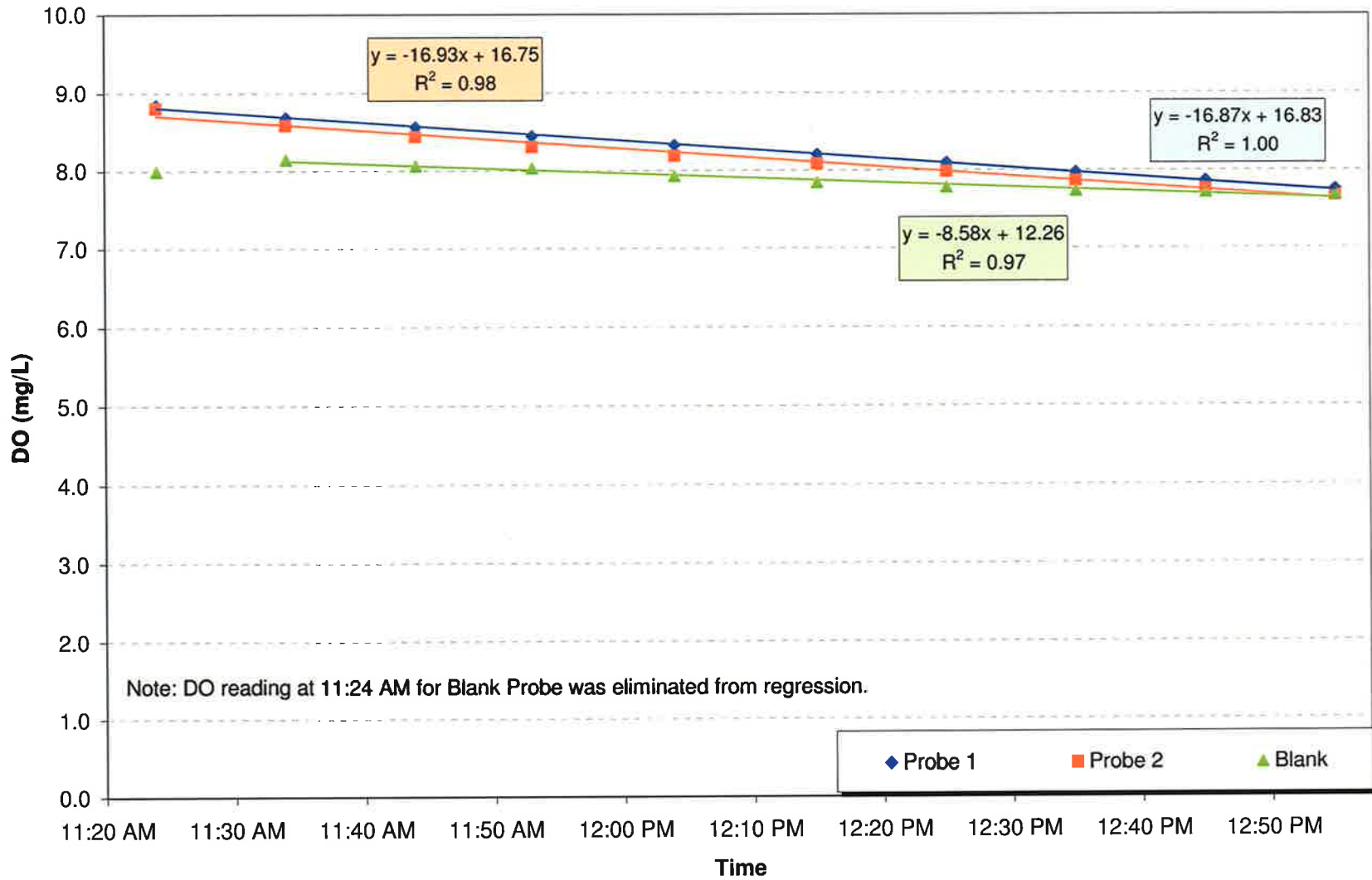
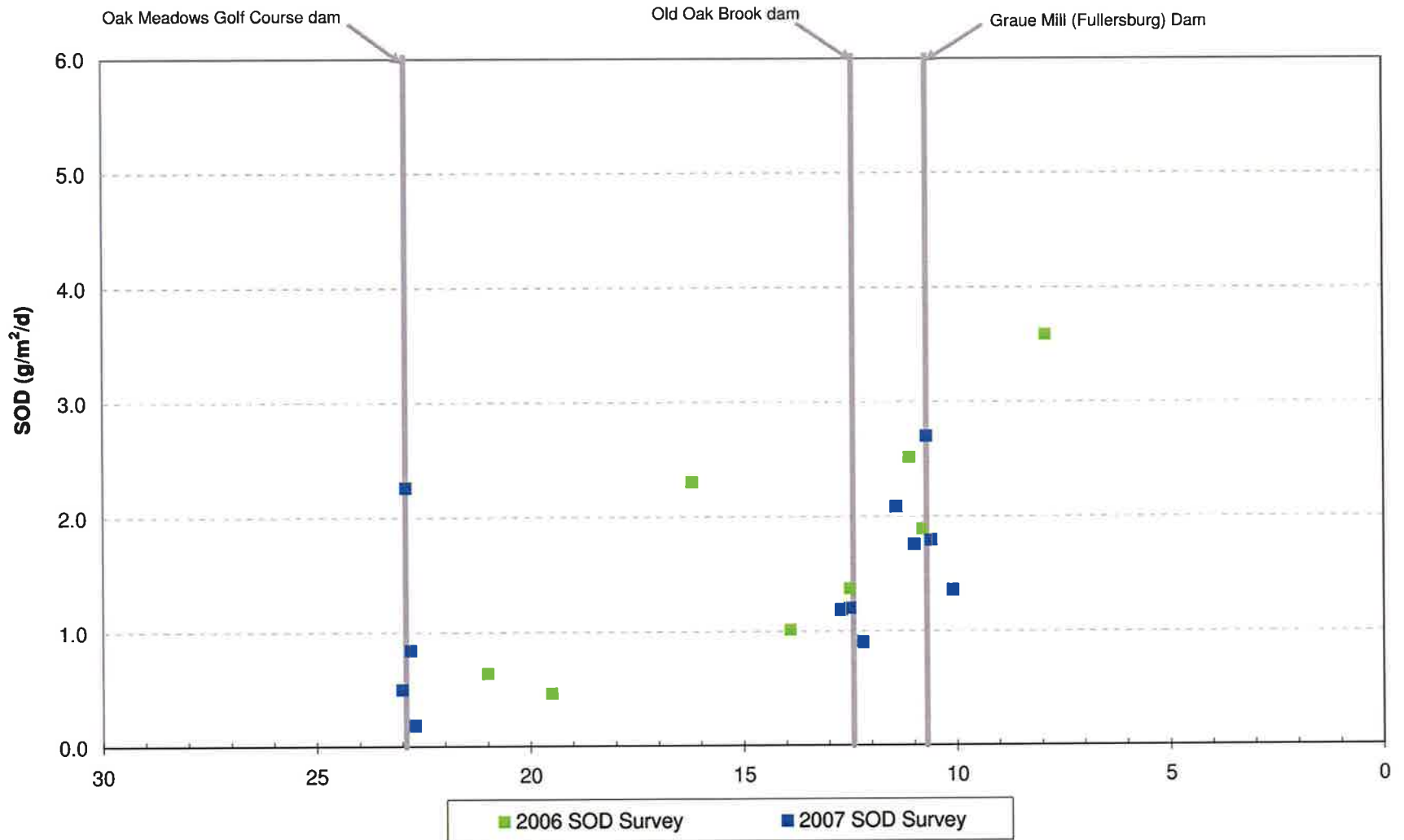


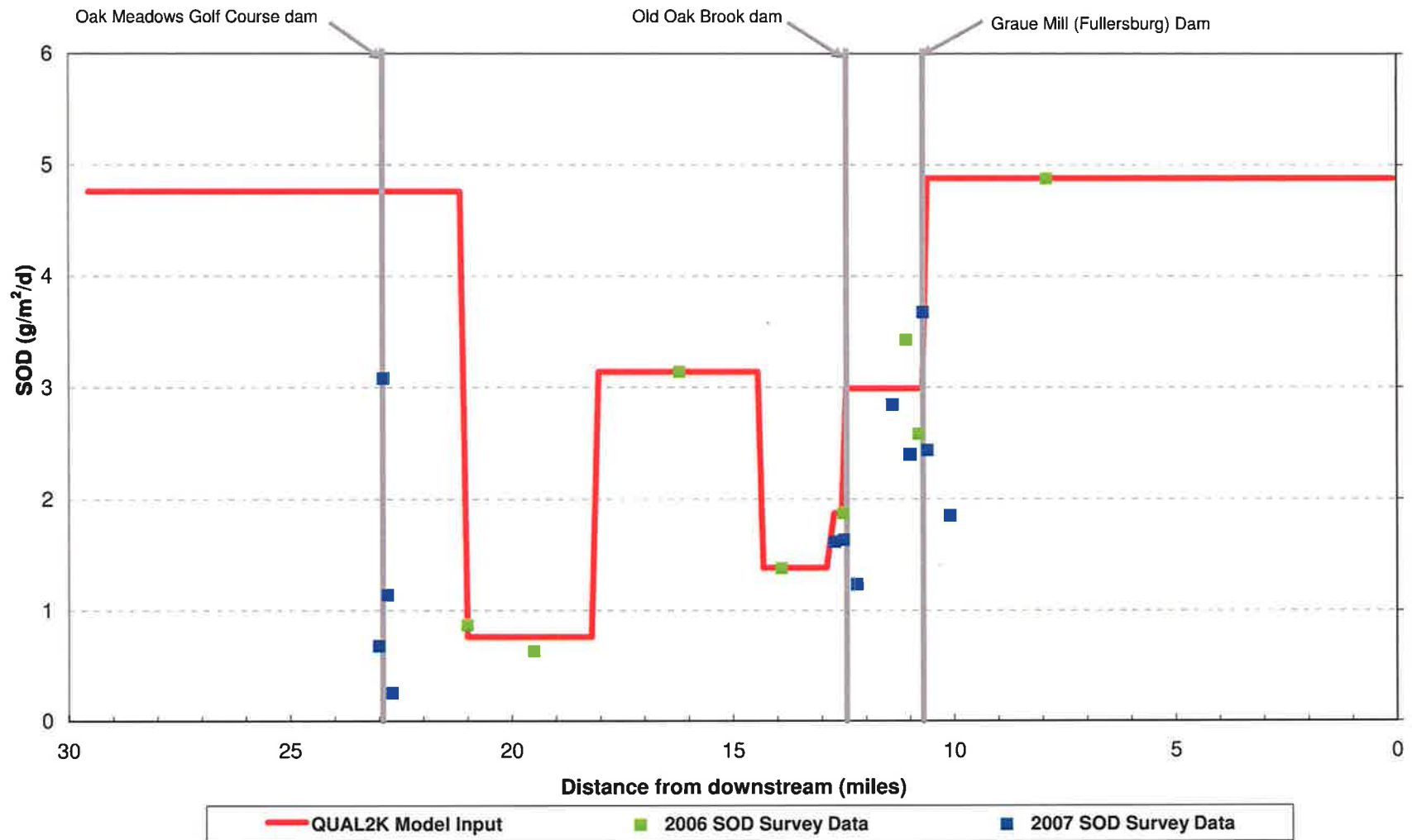
Figure 15: DO VS. Time  
In-Situ SOD Survey - Station L



**Figure 16**  
**Comparison of 20°C-Temperature Corrected SOD in Salt Creek**



**Figure 17**  
**Comparison of SOD Adjusted to Model Predicted Temperature for**  
**Calibration Period (8/15/06 - 8/17/06) in Salt Creek**



**Table 1: 2007 SOD Survey Locations**

Station	LAT	LONG	River Miles	Descriptions
A	17.30	-81.55	23.0	North of Oak Meadows Dam/in Golf Course
B	17.30	-81.55	22.9	North of Oak Meadows Dam/in Golf Course
C	17.30	-81.56	22.8	South of Oak Meadows Dam/north of I290
D	17.30	-81.56	22.7	South of Oak Meadows Dam/south of I290
E	16.95	-81.46	12.7	North of Oakbrook Road
F	16.94	-81.45	12.5	South of Oakbrook Road
G	16.93	-81.45	12.2	Spring Road Salt Creek junction (north of road)
H	16.93	-81.43	11.4	Northern Fullersburg Woods Impoundment
I	16.91	-81.43	11.0	Southern Fullersburg Woods Impoundment
J	16.91	-81.42	10.7	Southern FWI, north of spillway
K	16.90	-81.42	10.6	Downstream of York Road
L	16.91	-81.40	10.1	Wide Channel north of industrial park

**Table 2**  
**2007 SOD Measurement Station: A**

**Date:** 7/31/2007  
**Location:** Oak Meadows Golf Course, Upstream 2, North of Island, West side of Creek  
**River:** Width = 100 ft, Depth = 1-1.2 ft, % sediment composition = 75%  
**Sediment:** 2.5- 3.0 ft deep, light, fluffy, organic, little vegetation and debris

**DO Meter Air Calibration Info:**

	Meter 1	Meter 2	Meter 3
DO (mg/L)	7.22	6.98	7.12

**Photosynthesis reference and QC:**

	Time		Probe Reading	
	Start	End	DO (mg/L)	Temp. (°C)
Initial	11:44 AM		6.63	26.7
Light bottle	11:47 AM	1:21 PM	7.12	26.9
Dark bottle	11:47 AM	1:23 PM	6.21	26.6

**Measurements:**

Time	Probe 1		Probe 2		Blank	
	DO (mg/L)	Temp. (°C)	DO (mg/L)	Temp. (°C)	DO (mg/L)	Temp. (°C)
11:47 AM	6.31	25.5	6.19	25.7	6.47	25.6
11:57 AM	6.21	25.5	6.15	25.4	6.31	25.8
12:07 PM	6.10	25.7	6.09	25.4	6.23	25.9
12:17 PM	5.99	25.8	6.09	25.4	6.19	26.0
12:27 PM	5.89	25.9	6.07	25.5	6.16	26.1
12:37 PM	5.78	26.0	6.07	25.6	6.11	26.3
12:47 PM	5.69	26.1	6.03	25.6	6.03	26.4
12:57 PM	5.58	26.2	5.98	25.7	6.00	26.5
1:07 PM	5.48	26.3	5.96	25.8	5.94	26.5
1:17 PM	5.39	26.4	5.89	25.9	5.89	26.6

**Table 3**  
**2007 SOD Measurement Station: B**

**Date:** 7/31/2007  
**Location:** Oak Meadows Golf Course Upstream 1, 150 ft Upstream of Dam  
**River:** Width = 90 ft, Depth = 1.2- 2.0 ft, 100% sediment  
**Sediment:** 4 ft deep, light, fluffy, organic, lots of vegetative debris, 100% sediment on x-section

**DO Meter Air Calibration Info:**

	Meter 1	Meter 2	Meter 3
DO (mg/L)	7.68	7.60	7.60

**Photosynthesis reference and QC:**

	Time		Probe Reading	
	Start	End	DO (mg/L)	Temp. (°C)
Initial	9:27 AM		5.64	24.3
Light bottle	9:34 AM	11:08 AM	5.97	25.7
Dark bottle	9:34 AM	11:09 AM	5.07	25.0

**Measurements:**

Time	Probe 1		Probe 2		Blank	
	DO (mg/L)	Temp. (°C)	DO (mg/L)	Temp. (°C)	DO (mg/L)	Temp. (°C)
9:32 AM	5.07	24.0	5.37	24.3	5.36	24.1
9:42 AM	4.80	23.7	5.10	23.8	5.34	24.1
9:52 AM	4.63	23.8	4.97	23.8	5.29	24.1
10:02 AM	4.49	23.8	4.89	23.8	5.22	24.2
10:12 AM	4.35	23.8	4.79	23.9	5.22	24.2
10:22 AM	4.22	23.9	4.71	23.9	5.21	24.3
10:32 AM	4.09	24.0	4.62	24.0	5.17	24.3
10:42 AM	3.96	24.0	4.51	24.0	5.12	24.4
10:52 AM	3.84	24.1	4.45	24.1	5.09	24.5
11:02 AM	3.72	24.2	4.36	24.2	5.05	24.6



**Table 4**  
**2007 SOD Measurement Station: C**

**Date:** 8/1/2007  
**Location:** Golf Meadows Downstream 1, Upstream of 290  
**River:** Width = 45 ft, Depth = 0.9- 2.0 ft, 30% sediment on cross-section.  
**Sediment:** Depth 0.4- 0.8 ft, gravelly, silt

**DO Meter Air Calibration Info:**

	Meter 1	Meter 2	Meter 3
DO (mg/L)	8.36	8.40	8.40

**Photosynthesis reference and QC:**

	Time		Probe Reading	
	Start	End	DO (mg/L)	Temp. (°C)
Initial	9:22 AM		6.21	24.8
Light bottle	9:25 AM	10:58 AM	6.24	25.2
Dark bottle	9:25 AM	11:00 AM	6.18	24.9

**Measurements:**

Time	Probe 1		Probe 2		Blank	
	DO (mg/L)	Temp. (°C)	DO (mg/L)	Temp. (°C)	DO (mg/L)	Temp. (°C)
9:25 AM	5.54	24.4	5.45	24.6	5.72	24.5
9:35 AM	5.44	24.3	5.24	24.3	5.65	24.5
9:45 AM	5.38	24.3	5.17	24.4	5.62	24.6
9:55 AM	5.32	24.3	5.10	24.4	5.61	24.6
10:05 AM	5.27	24.4	5.04	24.4	5.59	24.6
10:15 AM	5.22	24.4	4.98	24.5	5.56	24.7
10:25 AM	5.17	24.4	4.93	24.5	5.54	24.7
10:35 AM	5.12	24.5	4.87	24.5	5.51	24.8
10:45 AM	5.07	24.5	4.82	24.6	5.48	24.8
10:55 AM	5.02	24.6	4.76	24.6	5.44	24.9

**Table 5**  
**2007 SOD Measurement Station: D**

**Date:** 8/1/2007  
**Location:** Oak Meadows, Downstream 2, Downstream of 290 East side of Creek  
**River:** Width = 90 ft, Depth = 2 ft, 40% sediment ON X-SECTION  
**Sediment:** 0.3- 0.4 ft deep, silty sand progressing to silty gravel

**DO Meter Air Calibration Info:**

	Meter 1*	Meter 2	Meter 3
DO (mg/L)	8.31	8.07	8.11

**Photosynthesis reference and QC:**

	Time		Probe Reading	
	Start	End	DO (mg/L)	Temp. (°C)
Initial	11:26 AM		6.22	25.6
Light bottle	11:33 AM	1:05 PM	6.58	26.5
Dark bottle	11:33 AM	1:07 PM	6.18	26.3

**Measurements:**

Time	Probe 1		Probe 2		Blank	
	DO (mg/L)	Temp. (°C)	DO (mg/L)	Temp. (°C)	DO (mg/L)	Temp. (°C)
11:31 AM	6.08	25.2	6.01	25.3	5.89	25.2
11:41 AM	6.06	24.9	5.87	25.0	5.83	25.3
11:51 AM	6.02	25.0	5.81	25.0	5.79	25.4
12:01 PM	5.98	25.0	5.76	25.1	5.79	25.5
12:11 PM	5.94	25.1	5.74	25.2	5.74	25.5
12:21 PM	5.90	25.2	5.66	25.3	5.69	25.6
12:31 PM	5.87	25.3	5.61	25.4	5.65	25.8
12:41 PM	5.82	25.4	5.56	25.5	5.62	25.9
12:51 PM	5.78	25.5	5.52	25.6	5.58	26.0
1:01 PM	5.74	25.6	5.47	25.7	5.52	26.1

Note: \* DO Probe - Plastic cover is damaged

**Table 6**  
**2007 SOD Measurement Station: E**

**Date:** 7/30/2007  
**Location:** Oak Brook Dam Upstream 2, N of 31st St  
**River:** 60 ft wide, 1.2 ft depth, % sediment unknown (~50% minimum), river is deep 2-3 ft  
**Sediment:** Depth 0.1- 0.3 ft, light, fluffy organic with hard clay underneath

**DO Meter Air Calibration Info:**

	Meter 1	Meter 2	Meter 3
DO (mg/L)	8.85	8.90	8.87

**Photosynthesis reference and QC:**

	Time		Probe Reading	
	Start	End	DO (mg/L)	Temp. (°C)
Initial	9:04 AM	10:45 AM	4.85	23.6
Light bottle			5.32	24.6
Dark bottle			5.23	23.9

**Measurements:**

Time	Probe 1		Probe 2		Blank	
	DO (mg/L)	Temp. (°C)	DO (mg/L)	Temp. (°C)	DO (mg/L)	Temp. (°C)
9:09 AM	4.91	23.4	4.74	23.3	5.10	23.6
9:19 AM	4.79	23.4	4.57	23.3	5.03	23.6
9:29 AM	4.72	23.4	4.48	23.3	5.00	23.6
9:39 AM	4.66	23.4	4.40	23.3	5.00	23.6
9:49 AM	4.60	23.4	4.33	23.3	4.93	23.6
9:59 AM	4.55	23.4	4.26	23.3	4.93	23.6
10:09 AM	4.50	23.4	4.19	23.3	4.93	23.6
10:19 AM	4.45	23.5	4.13	23.3	4.92	23.7
10:29 AM	4.40	23.5	4.07	23.3	4.88	23.7
10:39 AM	4.35	23.4	4.01	23.3	4.87	23.7

**Table 7**  
**2007 SOD Measurement Station: F**

**Date:** 7/30/2007  
**Location:** South of 31<sup>st</sup> St Oak Brook Dam  
**River:** 100ft wide, 1-1.3 ft deep, 20% sediment  
**Sediment:** 3.1- 3.4 ft deep, thick, fluffy organic

**DO Meter Air Calibration Info:**

	Meter 1	Meter 2	Meter 3
DO (mg/L)	8.34	8.26	8.28

**Photosynthesis reference and QC:**

	Time		Probe Reading	
	Start	End	DO (mg/L)	Temp. (°C)
Initial	11:16 AM	1:00 PM	6.13	24.5
Light bottle			5.75	26.1
Dark bottle			4.83	25.6

**Measurements:**

Time	Probe 1		Probe 2		Blank	
	DO (mg/L)	Temp. (°C)	DO (mg/L)	Temp. (°C)	DO (mg/L)	Temp. (°C)
11:21 AM	4.89	24.2	4.98	24.1	5.40	24.3
11:31 AM	4.71	24.0	4.99	24.0	5.47	24.4
11:41 AM	4.61	24.1	4.85	24.1	5.43	24.6
11:51 AM	4.52	24.2	4.74	24.2	5.38	24.7
12:01 PM	4.43	24.3	4.64	24.3	5.32	24.9
12:11 PM	4.34	24.5	4.54	24.4	5.28	25.1
12:21 PM	4.25	24.7	4.45	24.5	5.21	25.2
12:31 PM	4.17	24.5	4.35	24.6	5.19	25.3
12:41 PM	4.09	24.5	4.22	24.7	5.15	25.5
12:51 PM	4.01	25.1	4.19	24.9	5.11	25.6

**Table 8**  
**2007 SOD Measurement Station: G**

**Date:** 7/25/2007  
**Location:** Oak Brook Dam-Downstream 1 OBD-DS1  
**River:** Width 35 ft, Depth 1.5-2.3 ft, 50% sediment, pool with sediment before a riffle, gravel & shell upstream  
**Sediment:** Depth 0.7-1.0 ft, sandy sediment

**DO Meter Air Calibration Info:**

	Meter 1	Meter 2	Meter 3
DO (mg/L)	8.26	8.15	8.09

**Photosynthesis reference and QC:**

	Time		Probe Reading	
	Start	End	DO (mg/L)	Temp. (°C)
Initial	9:55 AM		6.66	24.4
Light bottle	10:06 AM	11:42 AM	7.05	25.0
Dark bottle	10:06 AM	11:42 AM	6.68	24.7

**Measurements:**

Time	Probe 1		Probe 2		Blank	
	DO (mg/L)	Temp. (°C)	DO (mg/L)	Temp. (°C)	DO (mg/L)	Temp. (°C)
10:06 AM	6.53	24.0	6.54	24.0	6.31	24.3
10:16 AM	6.50	24.0	6.49	23.9	6.29	24.3
10:26 AM	6.43	24.0	6.44	23.9	6.26	24.3
10:36 AM	6.36	24.0	6.40	24.0	6.24	24.4
10:46 AM	6.30	24.1	6.39	24.0	6.26	24.4
10:56 AM	6.24	24.1	6.30	24.1	6.21	24.5
11:06 AM	6.17	24.2	6.25	24.2	6.21	24.5
11:16 AM	6.12	24.3	6.20	24.2	6.15	24.5
11:26 AM	6.06	24.3	6.16	24.3	6.15	24.7
11:36 AM	5.99	24.4	6.10	24.4	6.15	24.7

**Table 9**  
**2007 SOD Measurement Station: H**

**Date:** 7/25/2007  
**Location:** Oak Brook Downstream 2. 500 ft North of Visitor Center  
**River:** Width 80 ft, Depth 1.7-2.4 ft, 25% sediment  
**Sediment:** Depth 0.5-1.0 ft, light, fluffy, silty and highly organic

**DO Meter Air Calibration Info:**

	Meter 1	Meter 2	Meter 3
DO (mg/L)	7.48	7.57	7.77

**Photosynthesis reference and QC:**

	Time		Probe Reading	
	Start	End	DO (mg/L)	Temp. (°C)
Initial	12:45 PM		7.17	25.7
Light bottle	12:45 PM	2:20 PM	7.29	25.8
Dark bottle	12:45 PM	2:20 PM	6.87	25.7

**Measurements:**

Time	Probe 1		Probe 2		Blank	
	DO (mg/L)	Temp. (°C)	DO (mg/L)	Temp. (°C)	DO (mg/L)	Temp. (°C)
12:45 PM	6.93	25.5	6.80	24.9	6.68	25.8
12:55 PM	6.78	25.4	6.62	25.4	6.83	25.7
1:05 PM	6.64	25.3	6.49	25.3	6.78	25.7
1:15 PM	6.52	25.3	6.36	25.3	6.76	25.6
1:25 PM	6.39	25.3	6.23	25.2	6.73	25.6
1:35 PM	6.27	25.3	6.09	25.2	6.66	25.6
1:45 PM	6.14	25.2	5.97	25.2	6.63	25.5
1:55 PM	6.02	25.3	5.84	25.2	6.60	25.5
2:05 PM	5.90	25.3	5.72	25.2	6.57	25.6
2:15 PM	5.79	25.3	5.59	25.3	6.52	25.7

**Table 10**  
**2007 SOD Measurement Station: I**

**Date:** 8/1/2007  
**Location:** Grave Mill Upstream 2, where Creek turns north, opposite Salt Creek Circle  
**River:** Width 130 ft, Depth 1.6- 2.2 ft, 100% sediment  
**Sediment:** Depth 2.3- 2.7 ft, light, fluffy, gelatinous, organic

**DO Meter Air Calibration Info:**

	Meter 1	Meter 2	Meter 3
DO (mg/L)	7.62	7.51	7.58

**Photosynthesis reference and QC:**

	Time		Probe Reading	
	Start	End	DO (mg/L)	Temp. (°C)
Initial	2:51 PM		6.51	28.9
Light bottle	2:51 PM	4:36 PM	6.38	28.7
Dark bottle	2:51 PM	4:39 PM	6.37	28.6

**Measurements:**

Time	Probe 1		Probe 2		Blank	
	DO (mg/L)	Temp. (°C)	DO (mg/L)	Temp. (°C)	DO (mg/L)	Temp. (°C)
3:03 PM	5.88	28.3	5.90	28.4	5.98	28.7
3:13 PM	5.75	28.2	5.67	28.3	6.10	28.7
3:23 PM	5.60	28.2	5.49	28.3	6.05	28.7
3:33 PM	5.46	28.2	5.33	28.3	5.98	28.7
3:43 PM	5.31	28.2	5.17	28.3	5.93	28.7
3:53 PM	5.17	28.2	5.02	28.3	5.90	28.8
4:03 PM	5.03	28.3	4.87	28.3	5.85	28.8
4:13 PM	4.90	28.3	4.72	28.3	5.77	28.8
4:23 PM	4.76	28.3	4.59	28.3	5.73	28.8
4:33 PM	4.62	28.4	4.46	28.4	5.68	28.8

**Table 11**  
**2007 SOD Measurement Station: J**

**Date:** 7/24/2007  
**Location:** Just upstream of GM Dam along west bank  
**River:** Width 200 ft, Depth 1.8-2.2 ft, 100% sediment, slow flow above dam, murky, leeches  
**Sediment:** 0.8-2.0 ft deep, light fluffy gelatinous sediment

**DO Meter Air Calibration Info:**

2:35 DST	Meter 1	Meter 2	Meter 3
DO (mg/L)	8.49	8.28	7.72

**Photosynthesis reference and QC:**

	Time		Probe Reading	
	Start	End	DO (mg/L)	Temp. (°C)
Initial	2:37 PM		10.11	26.0
Light bottle	2:42 PM	4:47 PM	8.38	25.4
Dark bottle	2:42 PM	4:49 PM	8.17	25.2

**Measurements:**

Time	Probe 1		Probe 2		Blank	
	DO (mg/L)	Temp. (°C)	DO (mg/L)	Temp. (°C)	DO (mg/L)	Temp. (°C)
2:44 PM	9.78	25.7	9.70	25.6	8.80	26.0
2:54 PM	9.52	25.6	9.48	25.5	8.86	26.0
3:04 PM	9.29	25.5	9.27	25.5	8.82	25.9
3:14 PM	9.07	25.4	9.08	25.3	8.68	25.8
3:24 PM	8.87	25.4	8.90	25.3	9.13	25.8
3:34 PM	8.65	25.4	8.70	25.3	9.26	25.8
3:44 PM	8.46	25.3	8.53	25.3	9.55	25.9
3:54 PM	8.27	25.3	8.38	25.3	9.51	25.9
4:06 PM	8.10	25.3	8.22	25.3	9.47	25.8
4:16 PM	7.93	25.3	8.07	25.3	9.39	25.8
4:26 PM	7.75	25.3	7.92	25.3	9.31	25.8
4:36 PM	7.58	25.3	7.77	25.3	9.29	25.8
4:45 PM	7.43	25.3	7.64	25.3	9.17	25.7

Note: Installed plug in Probe 3 between 3:14 PM and 3:24 PM.  
Pump hose came loose in Probe 3 between 3:44 PM and 3:54 PM.



**Table 12**  
**2007 SOD Measurement Station: K**

**Date:** 7/24/2007  
**Location:** SC downstream, along west bank, of Grane Mill & York Road  
**River:** Width 80 - 90 ft, Depth 1.6 ft, 20% Sediment  
**Sediment:** 4.8 inches deep, sandy with silt

**DO Meter Air Calibration Info:**

	Meter 1	Meter 2	Meter 3
DO (mg/L)	9.08	9.07	9.08

**Photosynthesis reference and QC:**

	Time		Probe Reading	
	Start	End	DO (mg/L)	Temp. (°C)
Initial	9:00 AM		7.13	23.9
Light bottle	9:09 AM	10:45 AM	7.60	24.7
Dark bottle	9:09 AM	10:47 AM	7.03	24.2

**Measurements:**

Time	Probe 1		Probe 2		Blank	
	DO (mg/L)	Temp. (°C)	DO (mg/L)	Temp. (°C)	DO (mg/L)	Temp. (°C)
9:09 AM	7.08	23.7	7.20	23.8	6.53	24.0
9:18 AM	6.90	23.8	7.04	23.9	6.58	24.1
9:28 AM	6.80	23.8	6.95	23.9	6.56	24.1
9:39 AM	6.70	23.8	6.85	23.9	6.52	24.1
9:50 AM	6.60	23.9	6.75	23.9	6.50	24.1
10:01 AM	6.51	23.9	6.67	24.0	6.45	24.1
10:11 AM	6.42	23.9	6.58	24.0	6.49	24.2
10:22 AM	6.32	24.0	6.49	24.1	6.47	24.3
10:33 AM	6.23	24.1	6.40	24.1	6.41	24.3
10:42 AM	6.15	24.2	6.33	24.2	6.38	24.5

Note: Plug out on Probe 1

**Table 13**  
**2007 SOD Measurement Station: L**

**Date:** 7/24/2007  
**Location:** SC West Bank Behind Robert Clolun Center  
**River:** Width 250 ft, Depth 1.5-2.0 ft, 90% sediment, murky brown  
**Sediment:** 0.8-1.0 ft deep, silty sand with lots of organic matter

**DO Meter Air Calibration Info:**

	Meter 1	Meter 2	Meter 3
DO (mg/L)	9.68	9.24	8.43

**Photosynthesis reference and QC:**

	Time		Probe Reading	
	Start	End	DO (mg/L)	Temp. (°C)
Initial	11:21 AM		8.70	25.0
Light bottle	11:21 AM	12:57 PM	8.88	25.5
Dark bottle	11:21 AM	12:59 PM	8.27	25.4

**Measurements:**

Time	Probe 1		Probe 2		Blank	
	DO (mg/L)	Temp. (°C)	DO (mg/L)	Temp. (°C)	DO (mg/L)	Temp. (°C)
11:24 AM	8.85	24.8	8.81	24.8	8.00	25.0
11:34 AM	8.69	24.7	8.59	24.7	8.15	25.1
11:44 AM	8.57	24.8	8.44	24.8	8.07	25.2
11:53 AM	8.45	24.8	8.31	24.8	8.04	25.3
12:04 PM	8.33	24.9	8.19	24.9	7.94	25.5
12:15 PM	8.21	25.0	8.09	25.0	7.85	25.6
12:25 PM	8.10	25.1	7.99	25.0	7.79	25.7
12:35 PM	7.98	25.2	7.87	25.1	7.74	25.8
12:45 PM	7.87	25.2	7.78	25.2	7.72	25.8
12:55 PM	7.76	25.3	7.68	25.2	7.69	25.8

**Table 14: Summary of In-Situ Sediment Oxygen Demand (SOD) during 2007 SOD Survey**

In-Situ SOD Measurement Chamber Dimensions: Volume (L) = 64.86; Area (m<sup>2</sup>) = 0.27

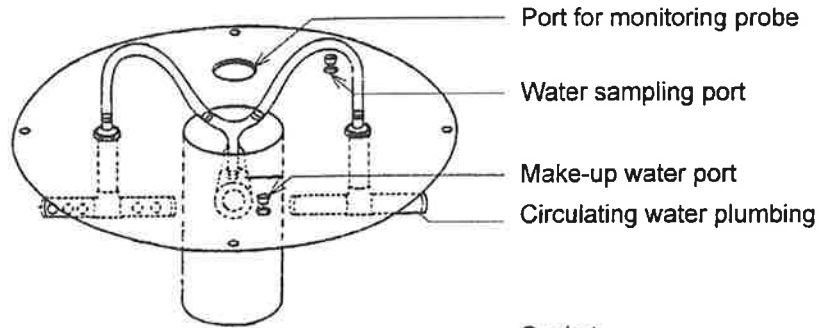
Station ID	Slope (mg/L/d)			SOD (g/m <sup>2</sup> /d)			Average Temperature (°C)		SOD (g/m <sup>2</sup> /d) - Temperature Corrected to 20 °C		
	Probe 1	Probe 2	Blank	Probe 1	Probe 2	Average	Probe 1	Probe 2	Probe 1	Probe 2	Average
A	-14.84	-4.15	-8.28	1.58	0.00	0.79	25.9	25.6	1.00	0.00	0.50
B	-20.55	-14.69	-4.84	3.77	2.37	3.07	23.9	24.0	2.79	1.74	2.27
C	-7.92	-9.79	-3.93	0.96	1.41	1.18	24.4	24.5	0.68	1.00	0.84
D	-5.58	-7.93	-5.59	0.00	0.56	0.28	25.2	25.3	0.00	0.37	0.19
E	-8.42	-10.93	-3.26	1.24	1.84	1.54	23.4	23.3	0.95	1.43	1.19
F	-13.41	-13.94	-6.65	1.62	1.75	1.69	24.4	24.4	1.16	1.25	1.20
G	-8.83	-6.99	-2.71	1.47	1.03	1.25	24.1	24.1	1.07	0.75	0.91
H	-18.14	-18.98	-5.50	3.04	3.24	3.14	25.3	25.2	2.02	2.17	2.09
I	-20.25	-22.60	-7.54	3.05	3.62	3.34	28.3	28.3	1.62	1.91	1.76
J	-27.40	-24.08	-8.69	4.49	3.70	4.10	25.4	25.4	2.96	2.45	2.70
K	-13.55	-12.82	-3.07	2.52	2.34	2.43	23.9	24.0	1.86	1.72	1.79
L	-16.87	-16.93	-8.58	1.99	2.01	2.00	25.0	25.0	1.36	1.37	1.36

Note: For Station A, SOD of Probe 2 is zero as DO depletion in the blank chamber was greater than in the Probe 2 chamber.

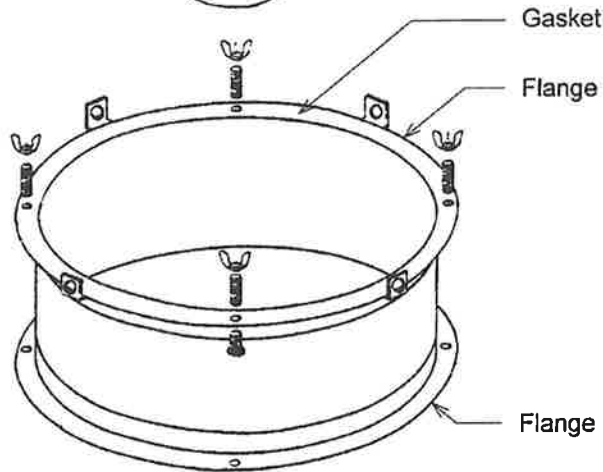
**Table 15: Summary of Average SOD in the Upstream and Downstream of the Dam during 2007 SOD Survey**

Dam	Loaction	SOD (g/m <sup>2</sup> /d) - Temperature Corrected to 20 °C
Oak Meadows Golf Course Dam	Upstream	1.38
	Downstream	0.51
Old Oak Brook Dam	Upstream	1.20
	Downstream	0.91
Graue Mill (Fullersburg) Dam	Upstream	2.19
	Downstream	1.58

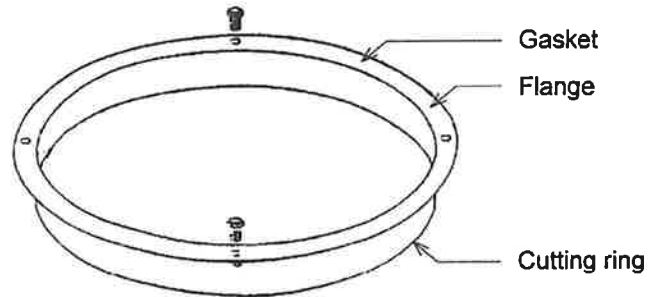
**LID**



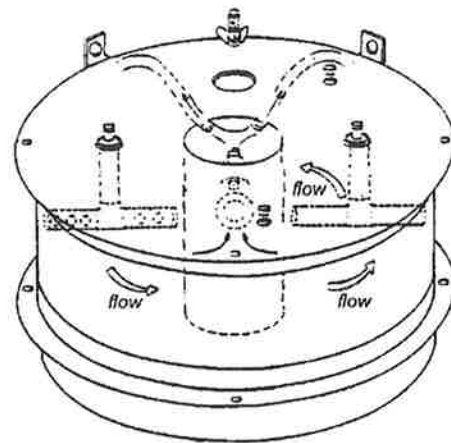
**BODY**



**FLANGE AND CUTTING EDGE**



**ASSEMBLED CHAMBER**



**DIMENSIONS**

Area = 0.27 m<sup>2</sup>  
Volume = 64.86 L



Henningson, Durham & Richardson  
Architecture and Engineering, P.C.  
in association with HDR Engineering, Inc.

One Blue Hill Plaza  
Pearl River, NY 10965

**In-Situ Sediment Oxygen Demand (SOD)  
Measurement Chamber**

**Figure  
1**



# Appendix C

Dams	KM	miles	
DAM 1 (OLD MEADOWS GOLF COURSE DAM)	36.9	0.0	22.913
DAM 1 (OLD MEADOWS GOLF COURSE DAM)	36.9	100.0	22.913
DAM 2 (OLD OAK BROOK DAM)	20.0	0.0	12.427
DAM 2 (OLD OAK BROOK DAM)	20.0	100.0	12.427
DAM 3 (FULLERSBURG WOODS DAM)	17.2	0.0	10.7
DAM 3 (FULLERSBURG WOODS DAM)	17.2	100.0	10.7

Reach Label	Distance (km)	Elevation (m)
EGAN - SPR BK	41.8	203.6
SPR BRK - ADD N	37.3	202.7
IMPOUNDMENT - DAM 1	36.9	201.9
DAM 1 (OLD MEADOWS GOLF COURSE DAM)	36.9	201.8
SPR BRK - LAKE ST	34.9	200.3
LAKE ST - ADD S	34.0	199.5
ADD S - ST CHAR	29.1	198.6
CSO REACH	28.0	198.3
STEEP REACH	26.9	197.3
FLAT REACH - POOL	24.3	196.8
POOL - RT 88	23.2	196.6
RT 88 - 31ST	20.6	196.4
31ST - FULL PARK 1	20.1	196.8
DAM 2 (OLD OAK BROOK DAM)	20.0	196.8
31ST - FULL PARK 2	17.9	194.5
IMPOUNDMENT - DAM 3	17.3	194.3
DAM 3 (FULLERSBURG WOODS DAM)	17.2	194.2
DWN FR FULL PARK	10.8	190.9
TO CONF ADD CR	5.1	188.0
TO CONF DES PLA	0	187.1014383

Location	RM	km											
			Min	Max	minus	plus	Average	Min	Max	minus	plus	Average	
Busse Lake Dam	29.66	47.73314304	July					August					
JFK Blvd	28.68	46.15598592	21.92	24.56	1.35	1.29	23.27	22.84	25.85	1.13	1.88	23.97	26.97
Thorndale Ave	26.95	43.3718208	22.45	25.64	1.52	1.67	23.97	22.76	25.82	1.52	1.54	24.28	27.28
Butterfield Rd	16.13	25.95871872											
Footbridge Fullersburg Woods	11.15	17.9441856											
York Rd	10.6	17.0590464											
Wolf Rd	8.11	13.05177984	23.65	28.26	2.43	2.19	26.08	22.50	27.66	2.57	2.59	25.07	28.07

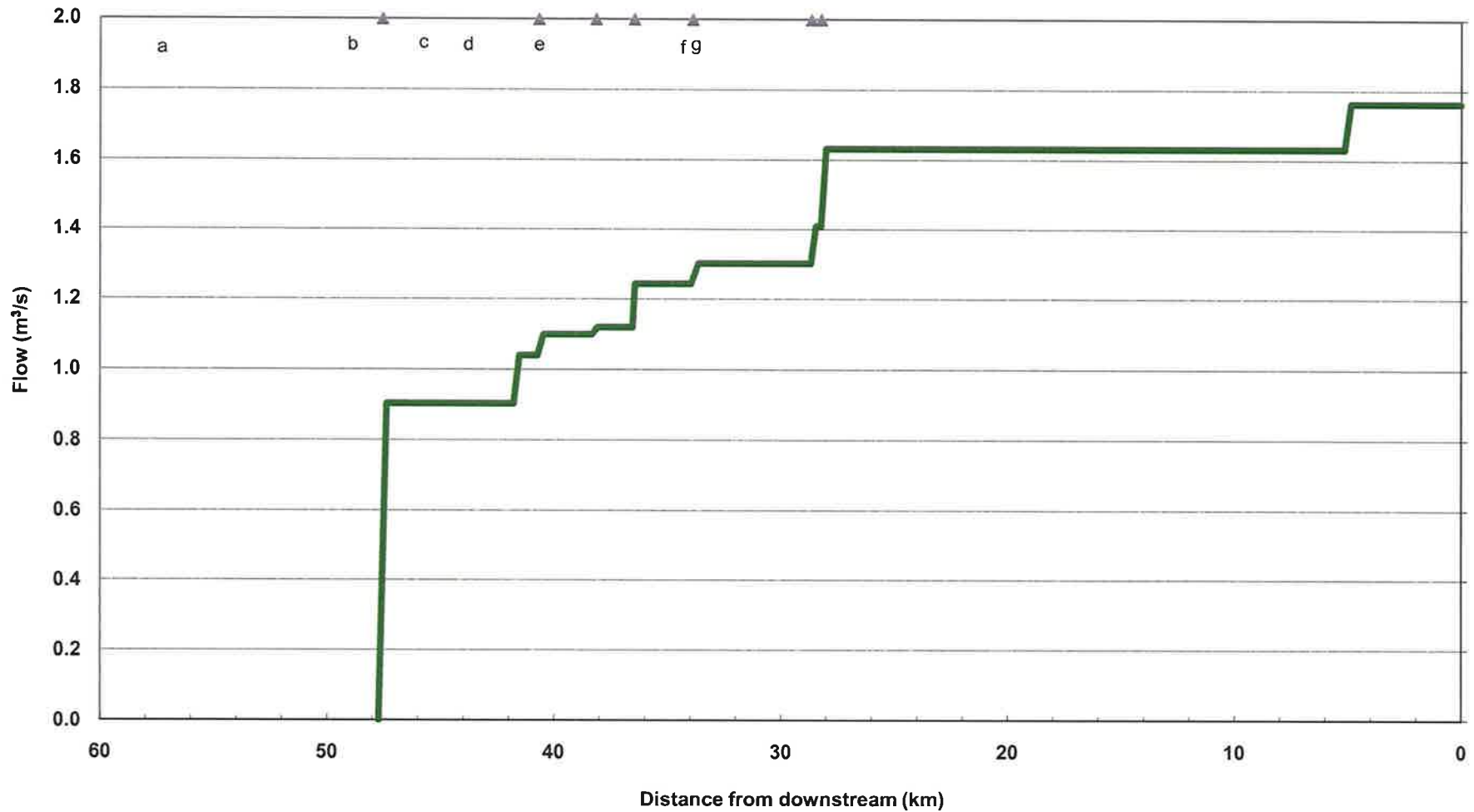






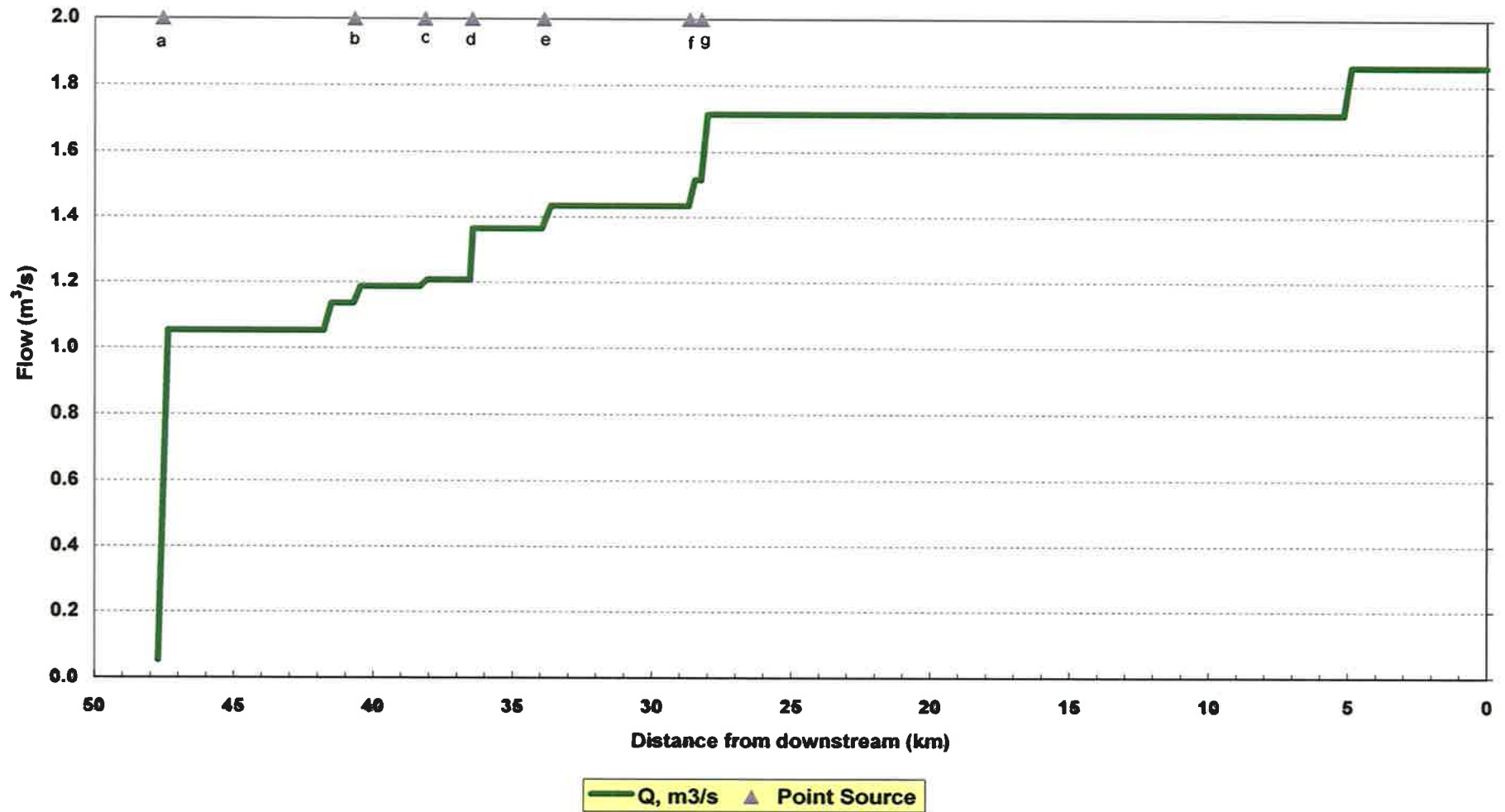
# Salt Creek (8/15/2006) Mainstem

All Dams Removed



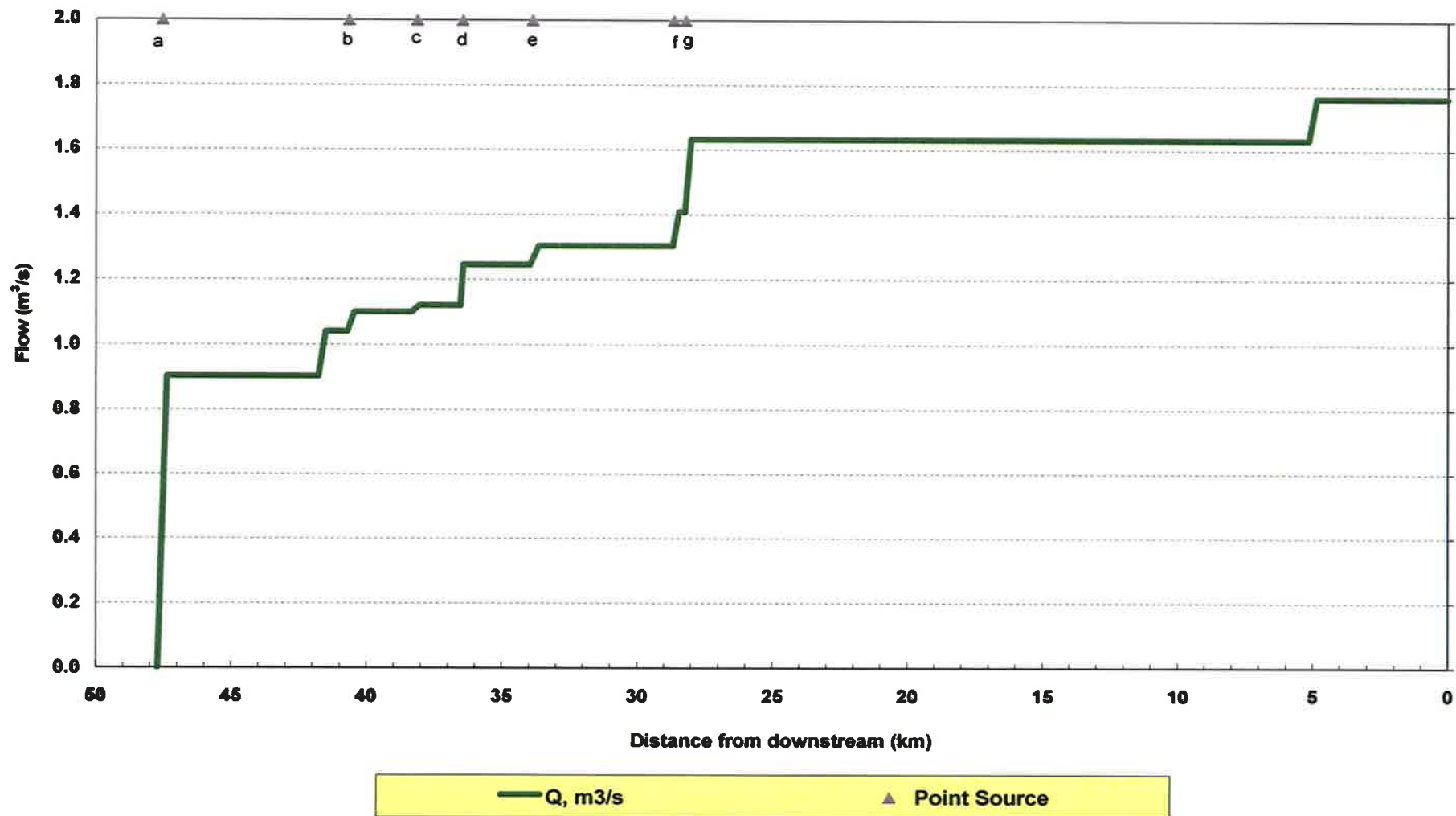
# Salt Creek (8/2/2007) Mainstem

Model Predicted Flow: 2007 Calibration Run



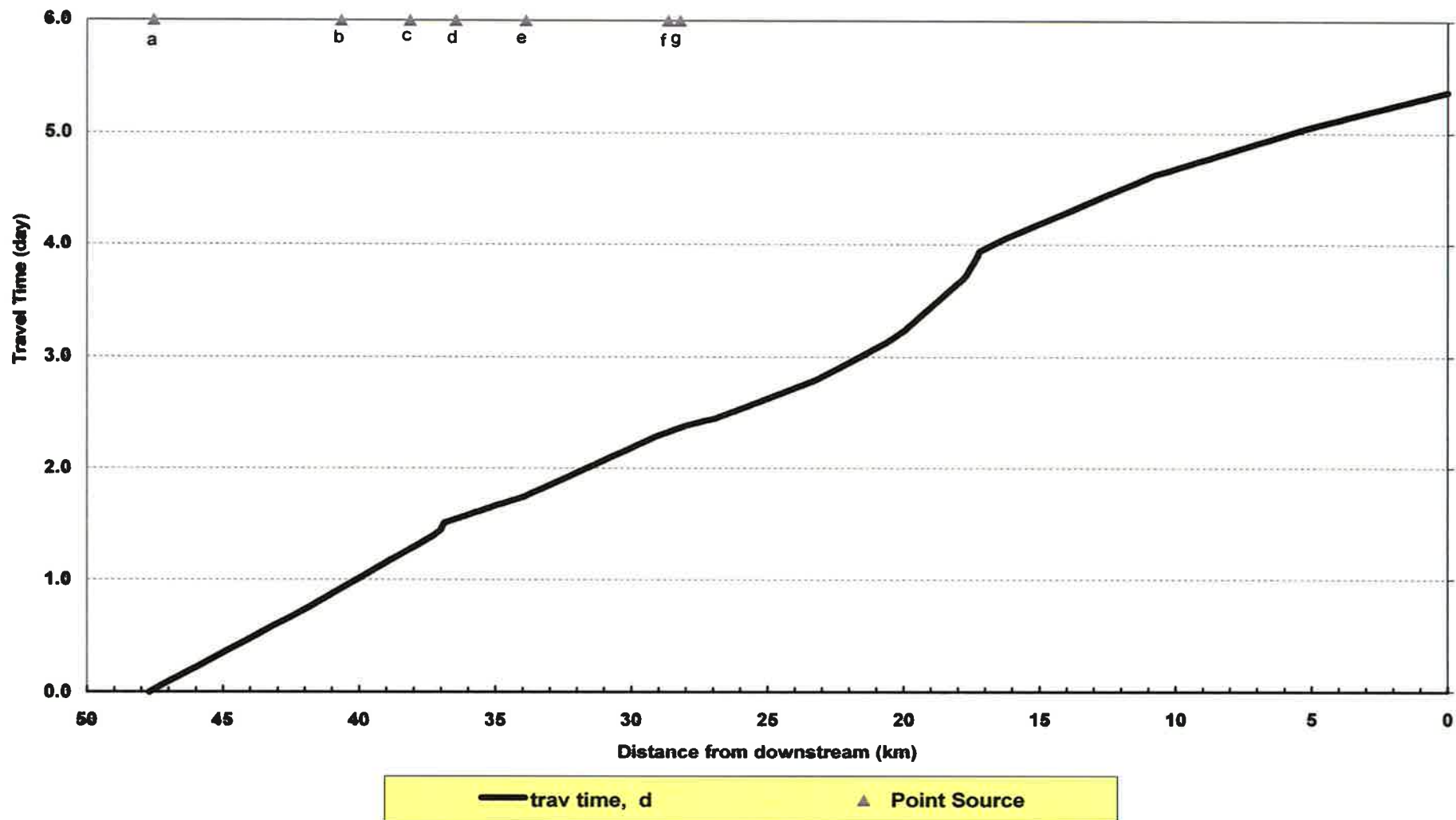
## Salt Creek Mainstem

Monthly Average of June 2005 DMR Condition with 3° C Increased Plant Discharge and Air Temperature



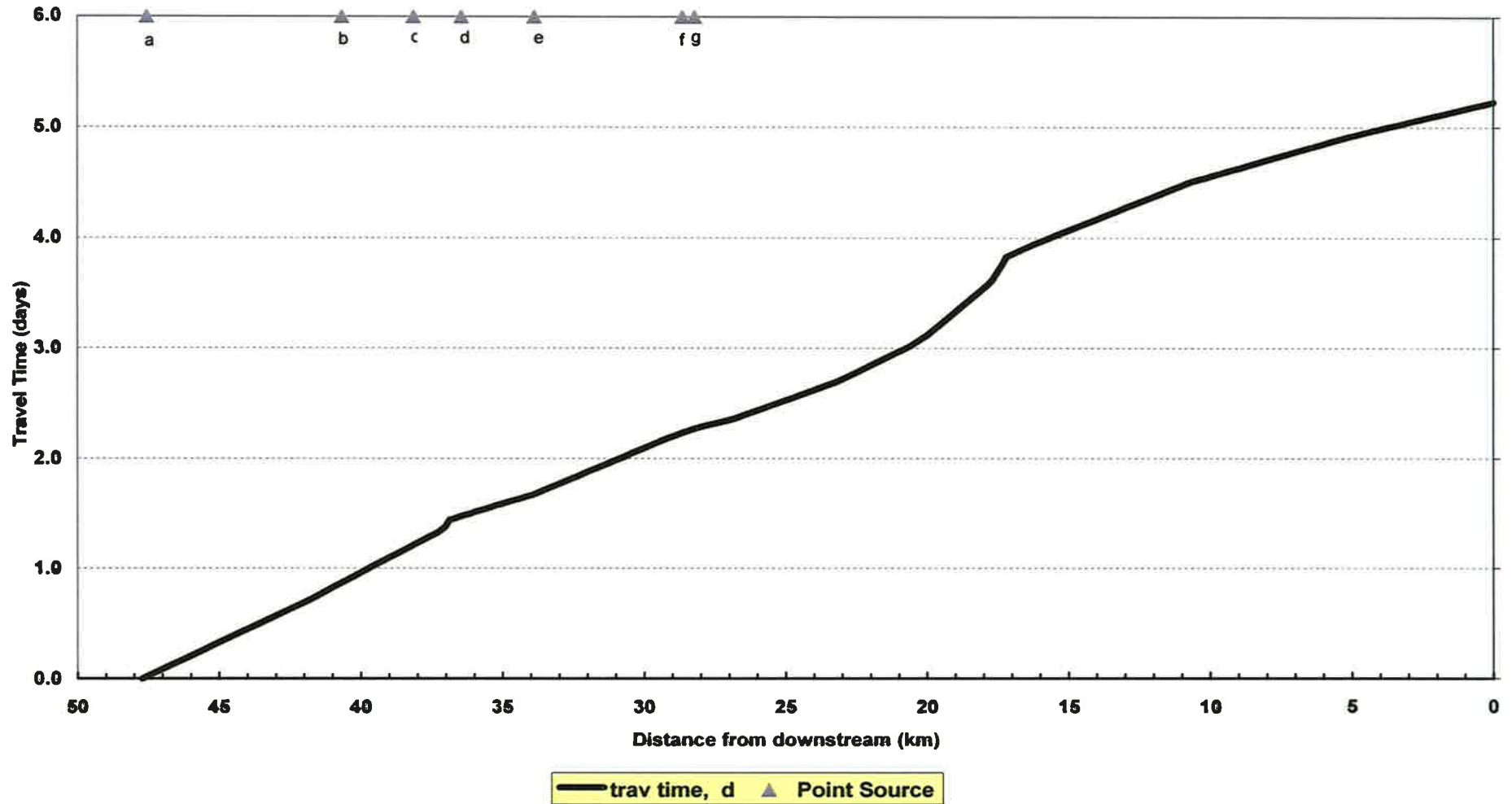
## Salt Creek Mainstem

Monthly Average of June 2005 DMR Condition with 3° C Increased Plant Discharge and Air Temperature

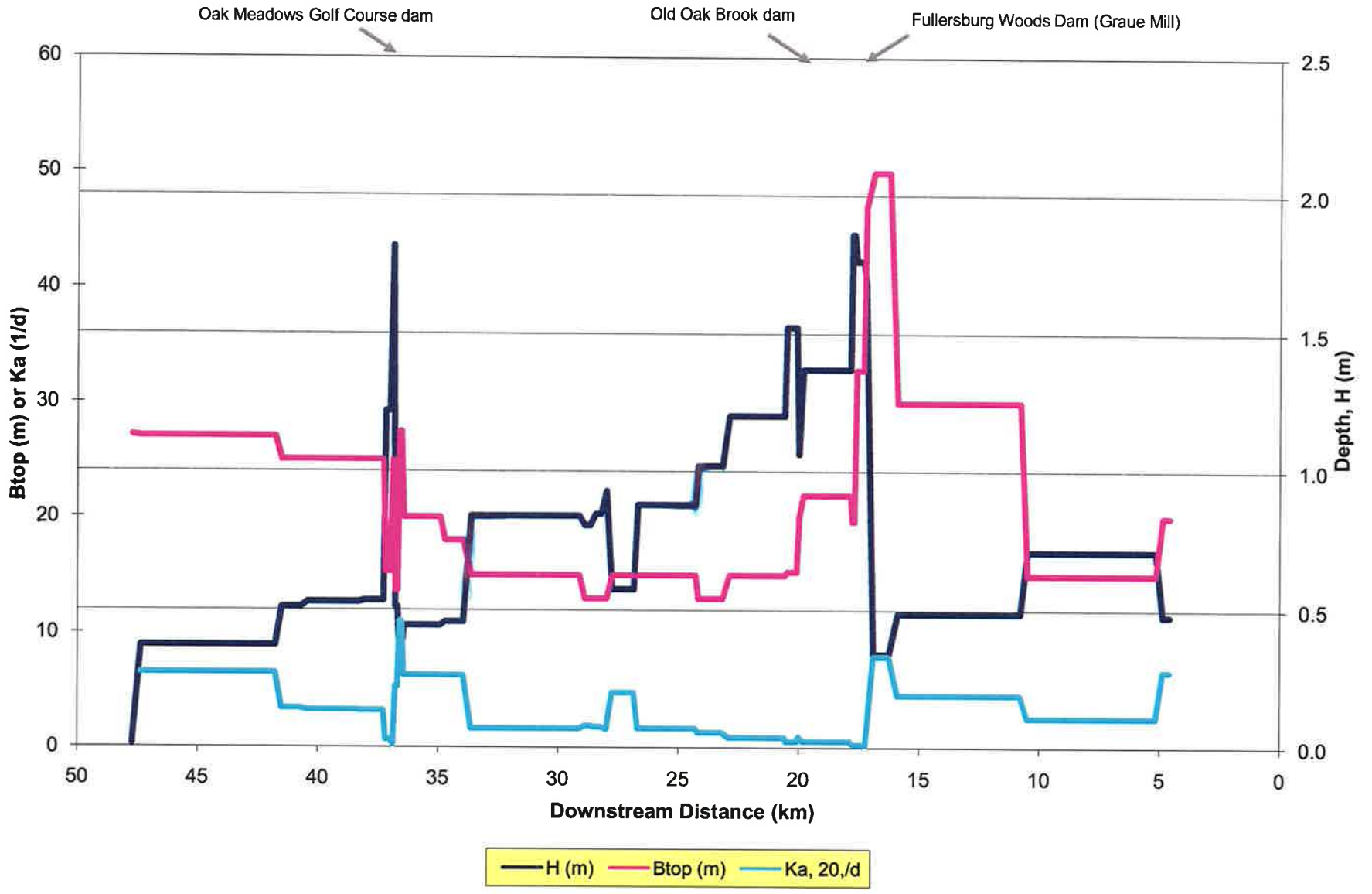


# Salt Creek (8/2/2007) Mainstem

Model Predicted Travel Time: 2007 Calibration Run



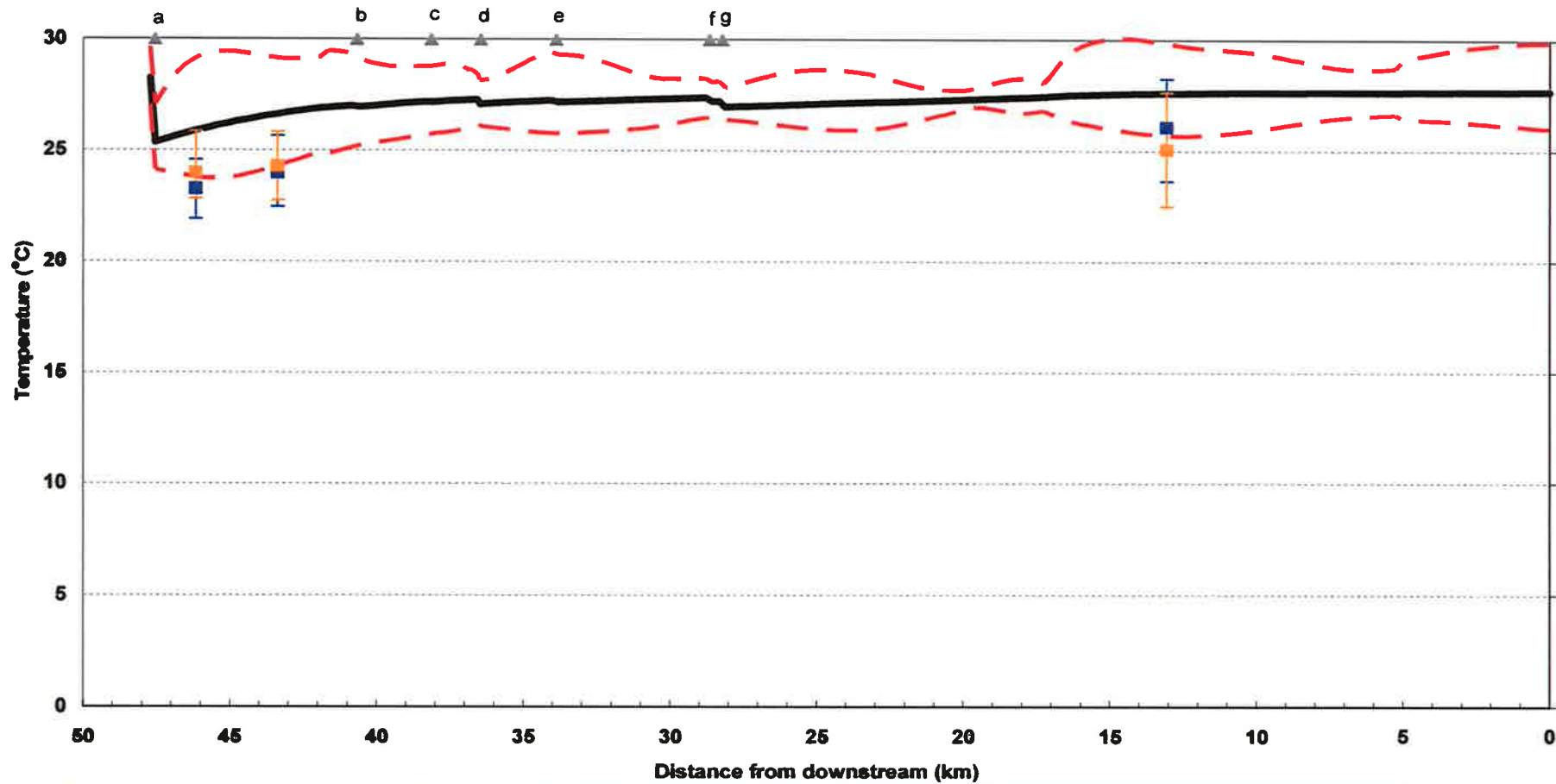
### Downstream Distance vs H, Btop, Ka





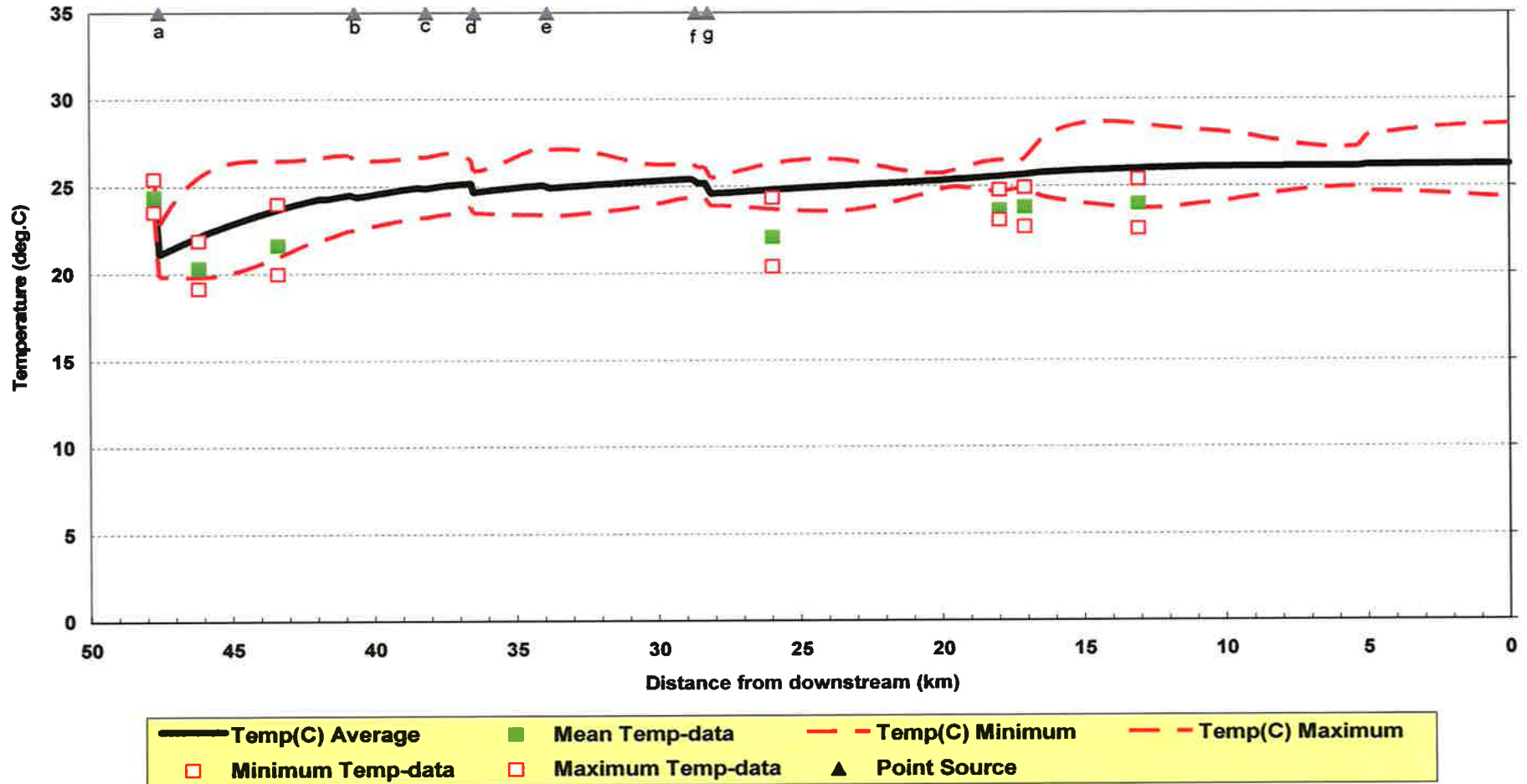
## Salt Creek Mainstem

Monthly Average of June 2005 DMR Condition with 3° C Increased Plant Discharge and Air Temperature



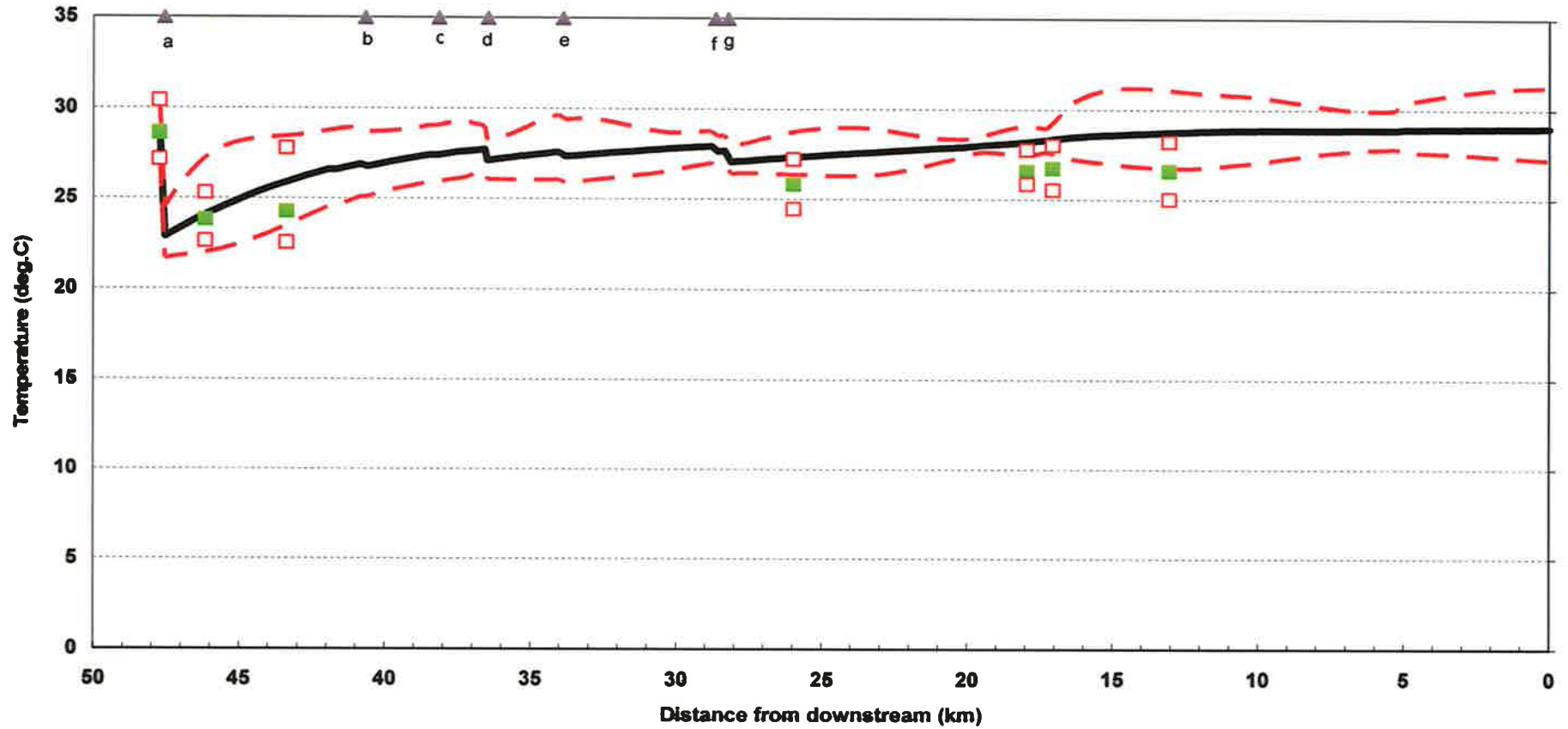
## Salt Creek (6/20/2006) Mainstem

Comparisons of Observed and Predicted Water Temperature:  
2006 Validation Run (6/19/06 to 6/21/06)

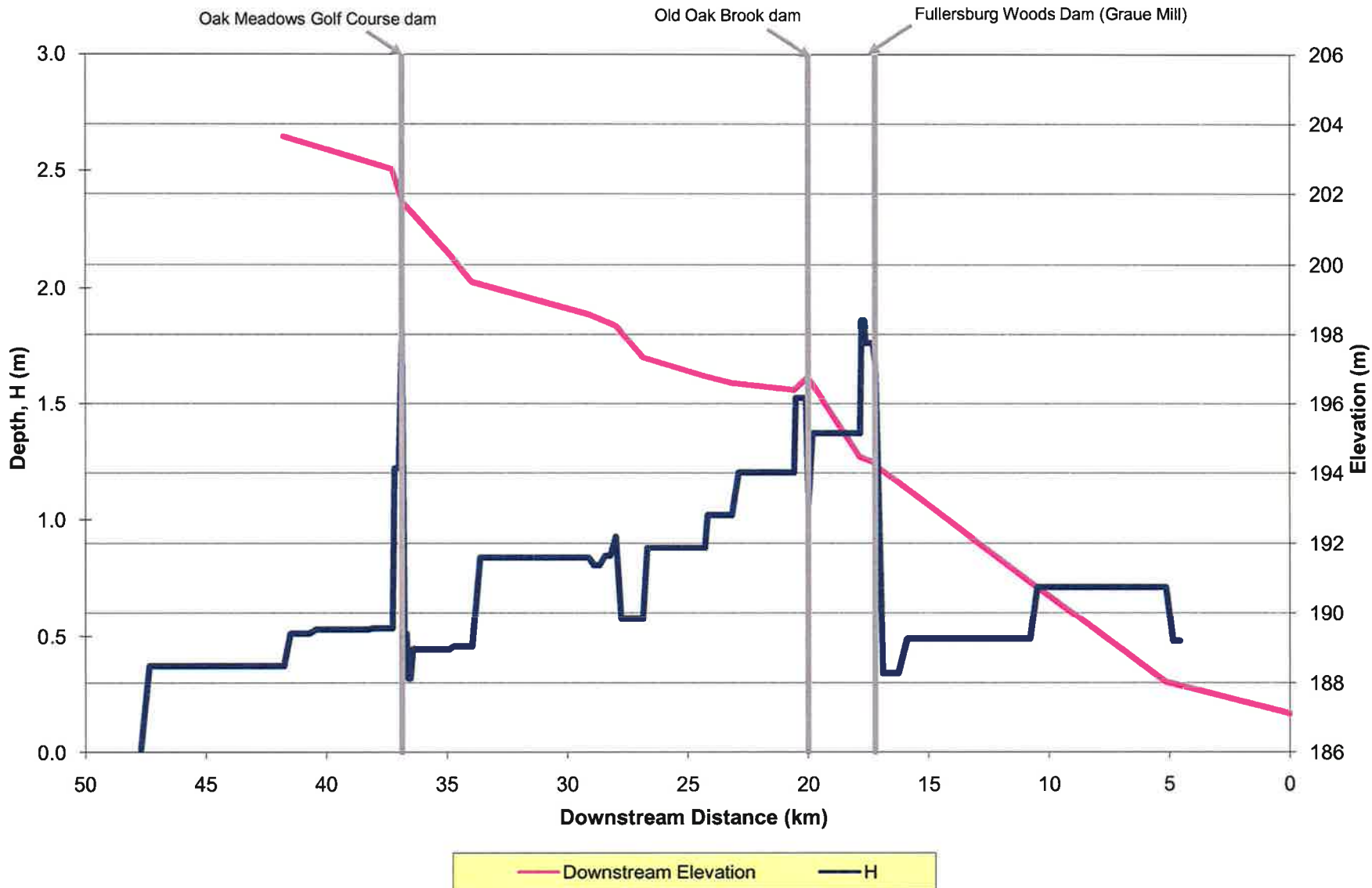


# Salt Creek (8/2/2007) Mainstem

Comparisons of Observed and Predicted Water Temperature:  
2007 Calibration Run



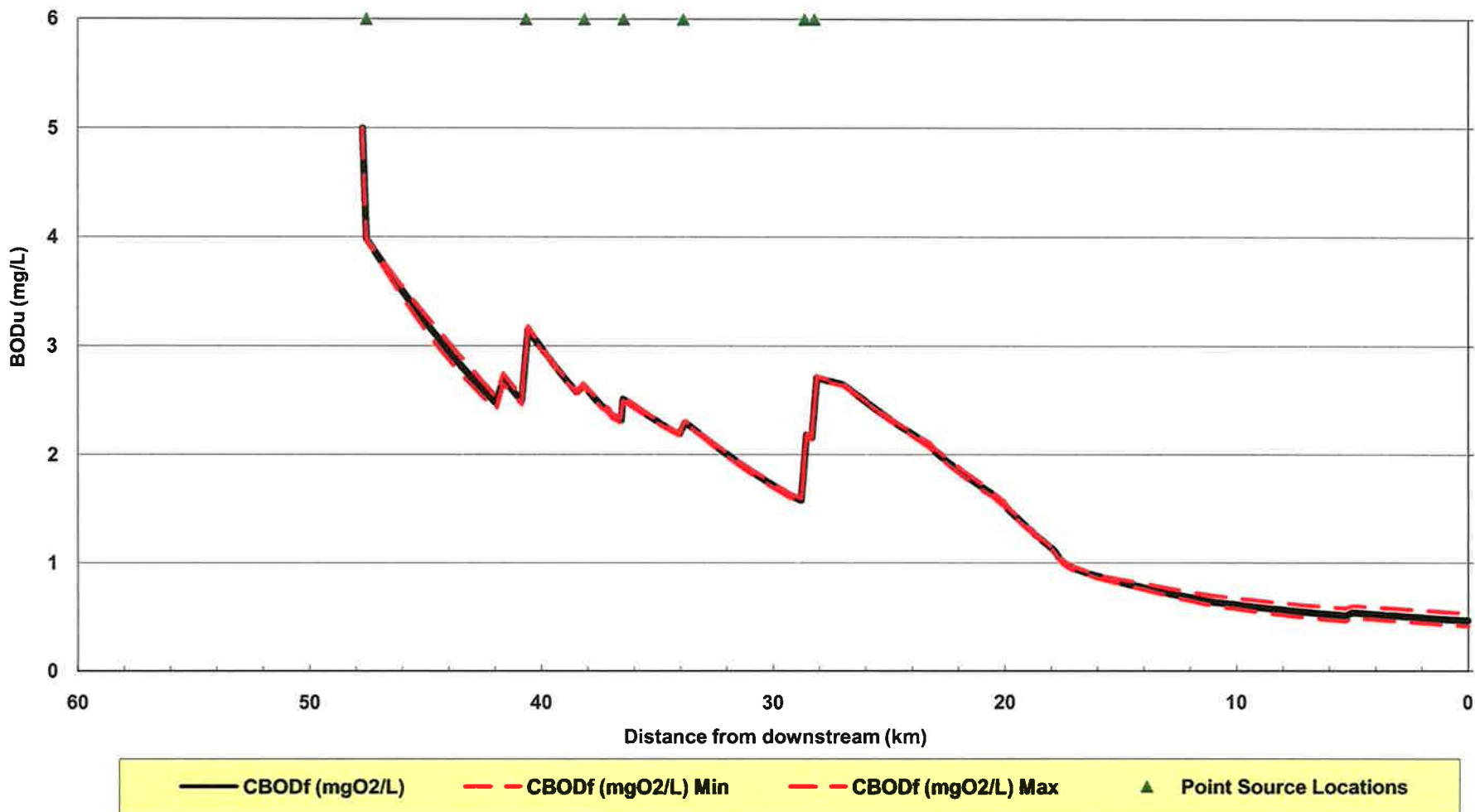
### Downstream Distance vs Elevation



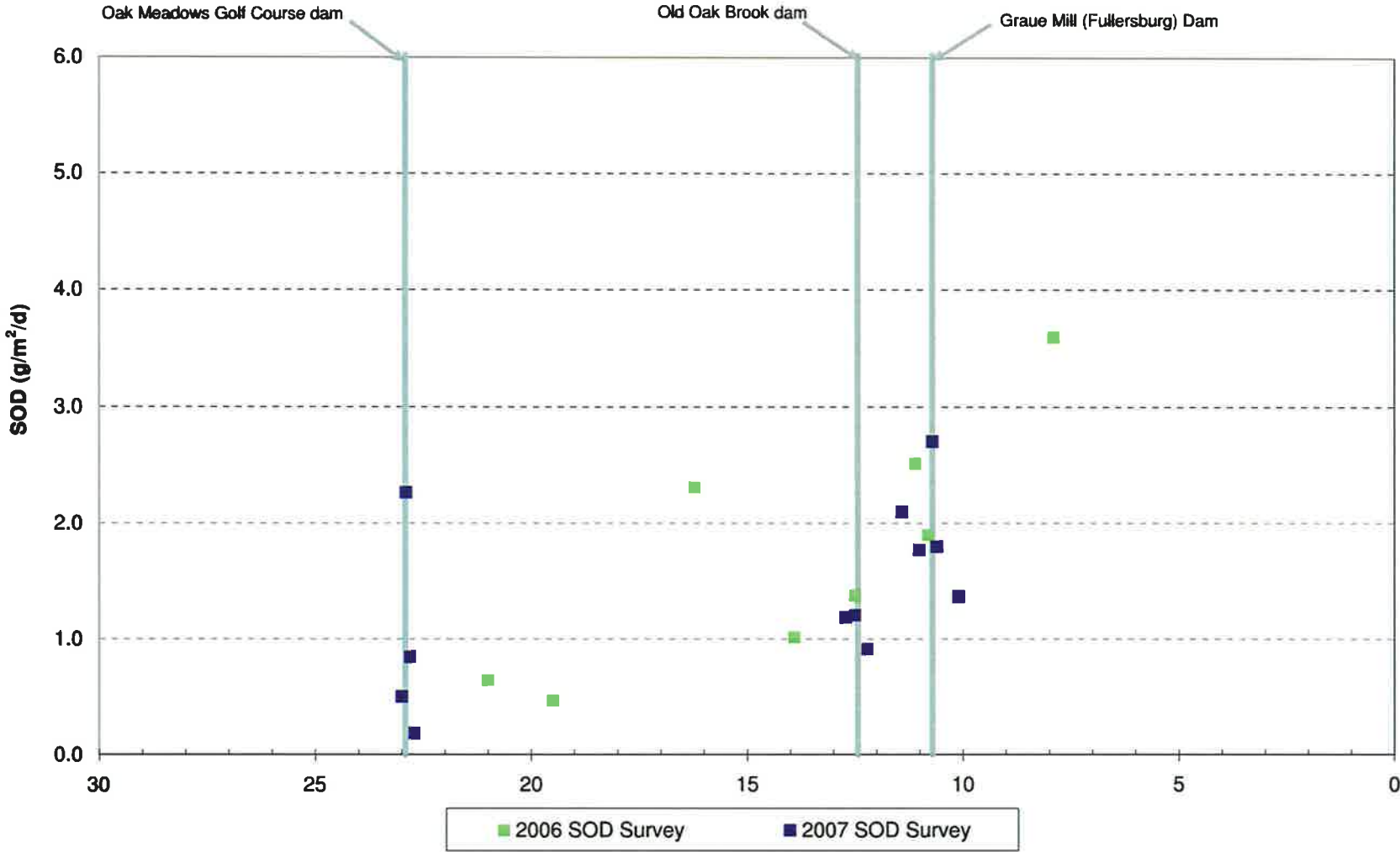
## Salt Creek (8/15/2006) Mainstem

Monthly Average of June 2005 DMR Condition with 3°C Increased Plant Discharge and Air Temperature

Note: A ratio of 2 of ultimate CBOD to CBOD5 was used to convert from permitted maximum CBOD5 concentration for point source input.

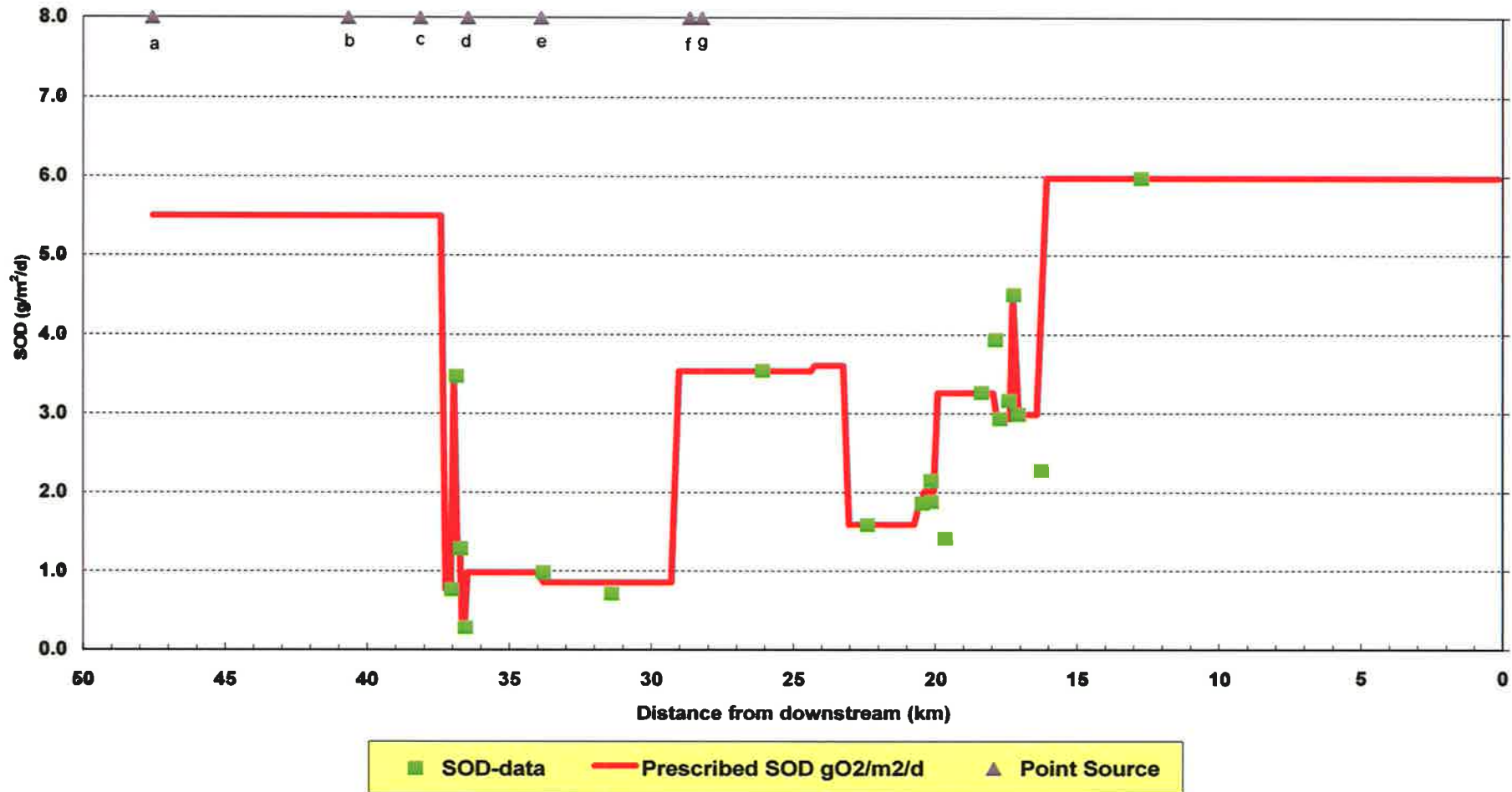


**Figure 16**  
**Comparison of 20°C-Temperature Corrected SOD in Salt Creek**



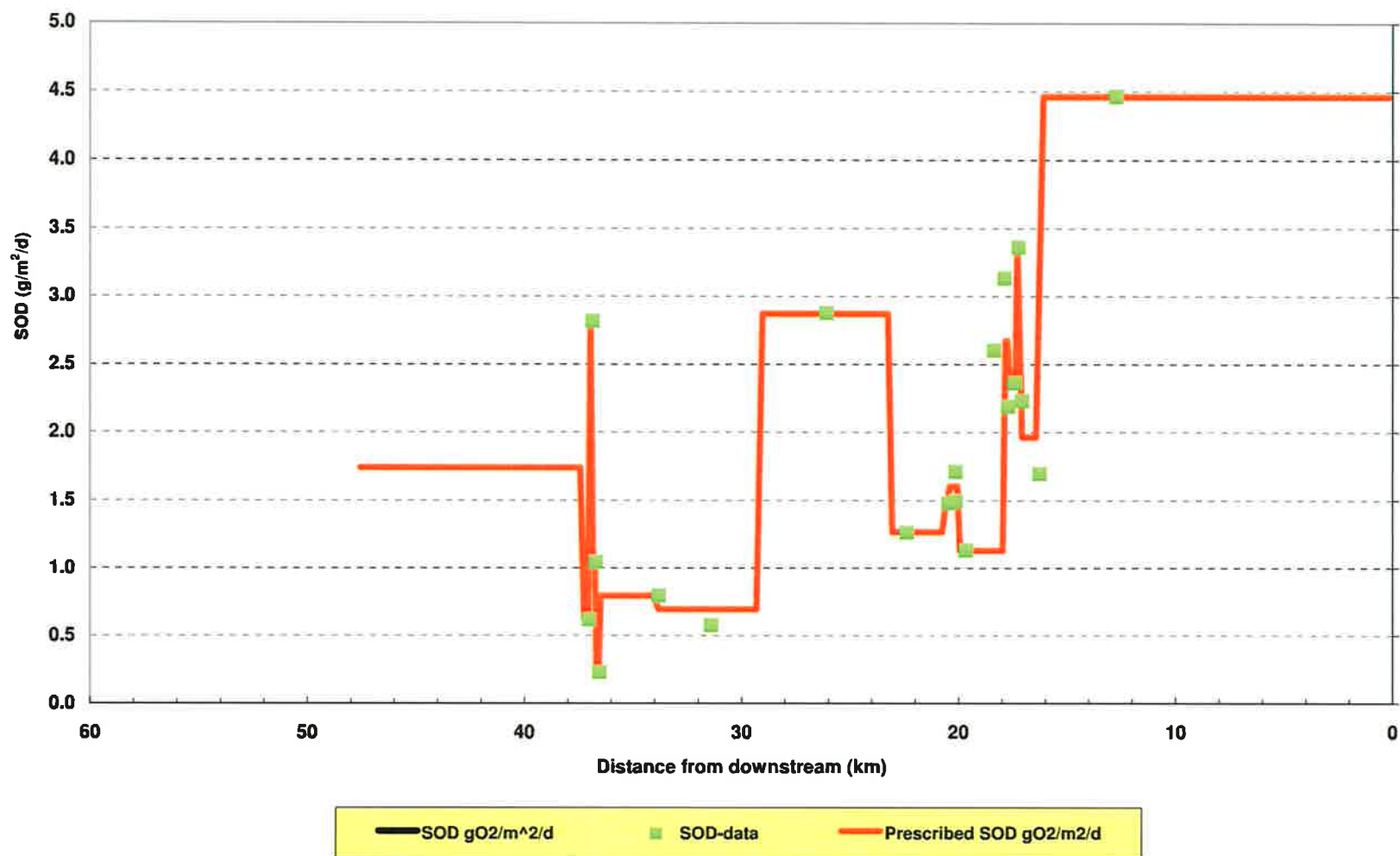
# Salt Creek (8/2/2007) Mainstem

Model Input of Sediment Oxygen Demand (SOD): 2007 Calibration Run



### Salt Creek

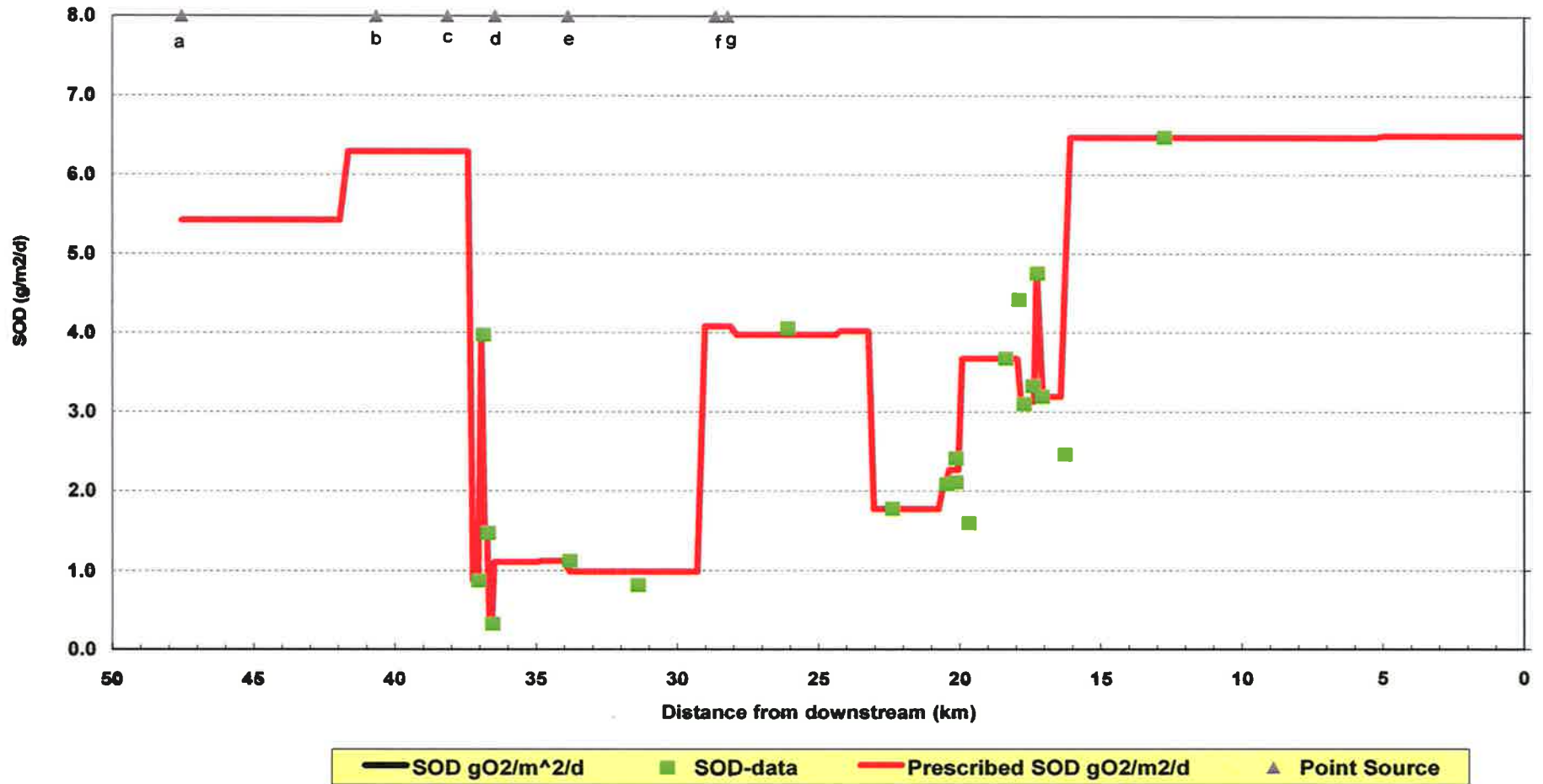
Model Input of Sediment Oxygen Demand (SOD): Validation Run (6/19/06 to 6/21/06)





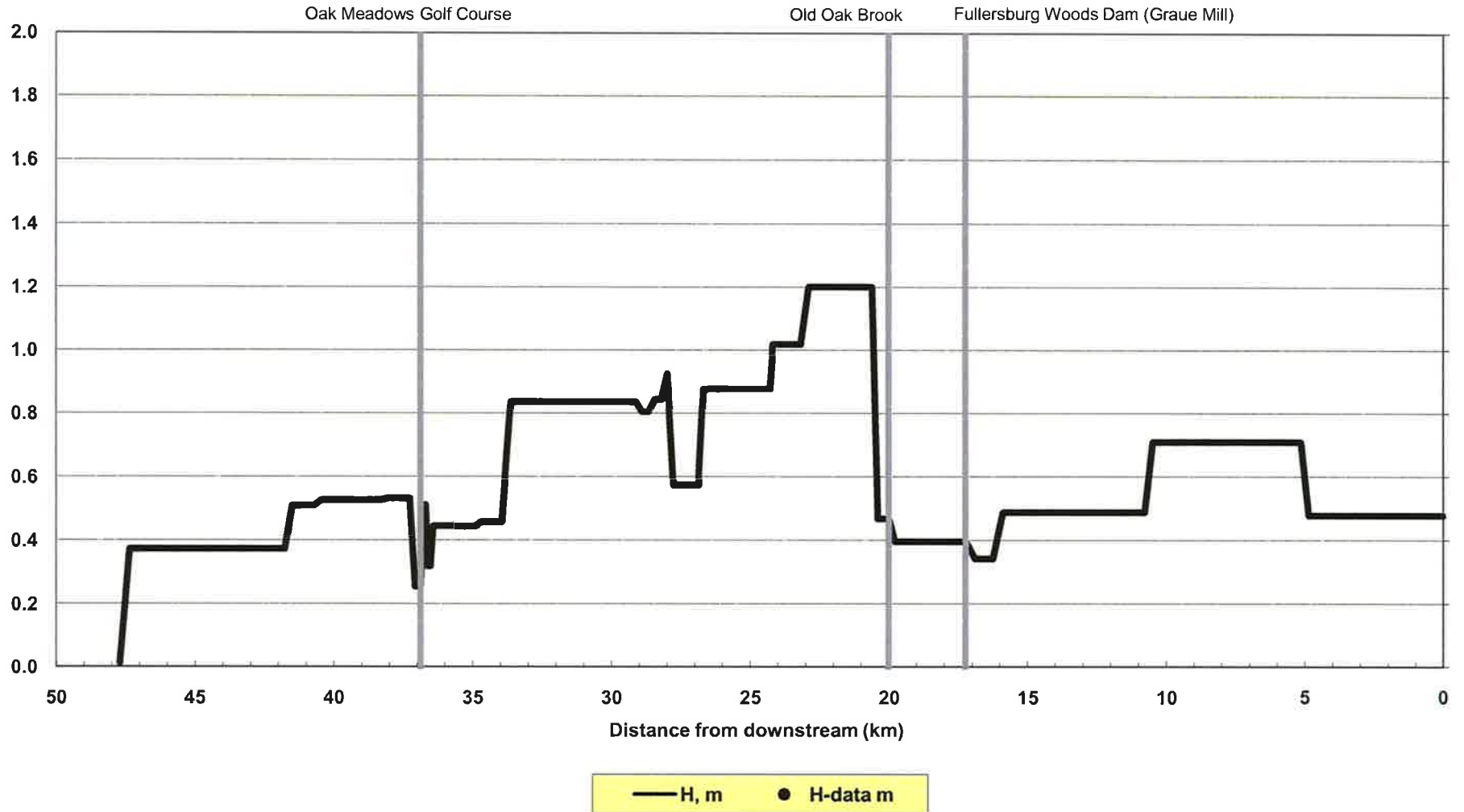
# Salt Creek Mainstem

Monthly Average of June 2005 DMR Condition with 3° C Increased Plant Discharge and Air Temperature



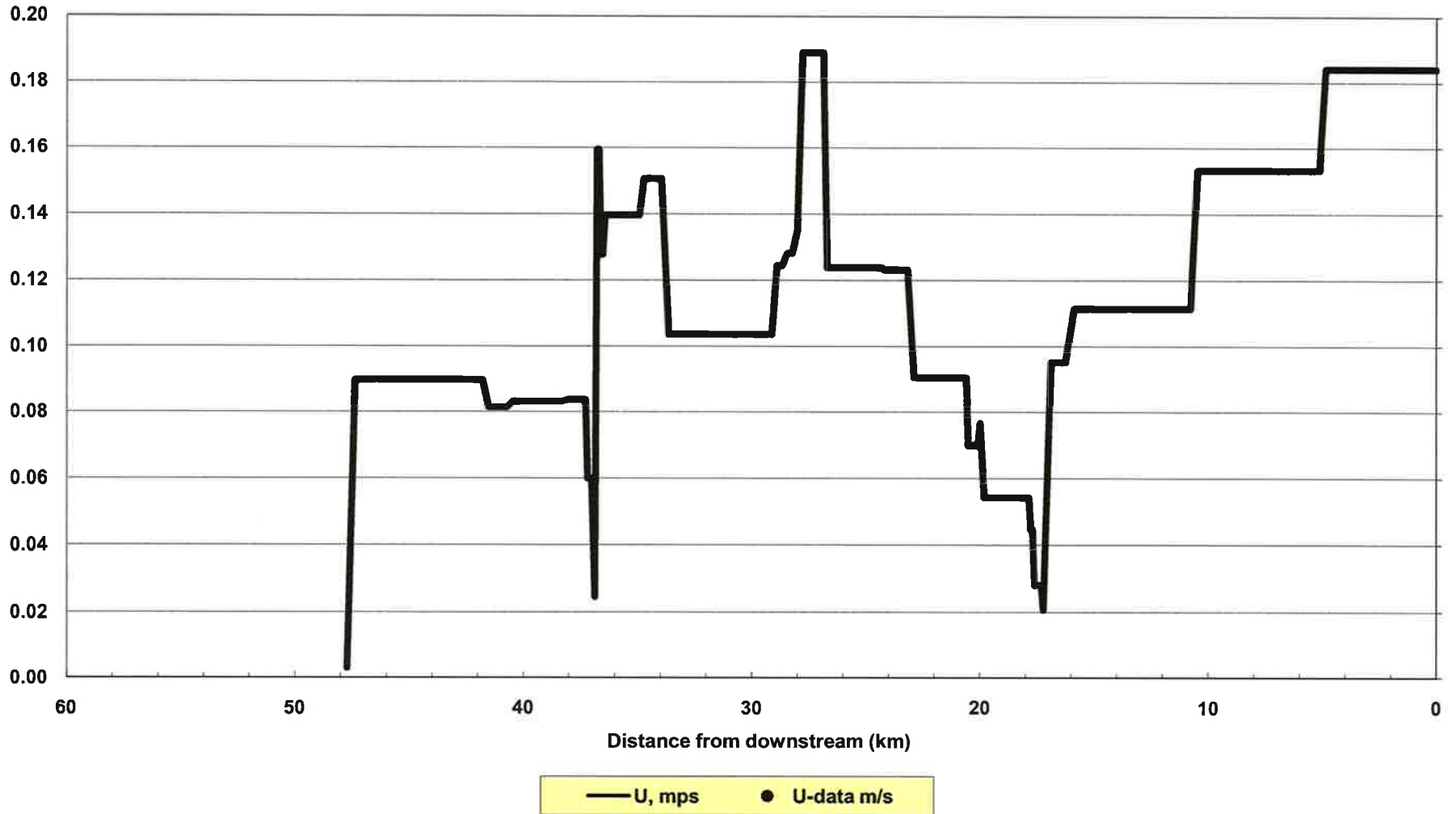
# Salt Creek (8/15/2006) Mainstem

All Dams Removed



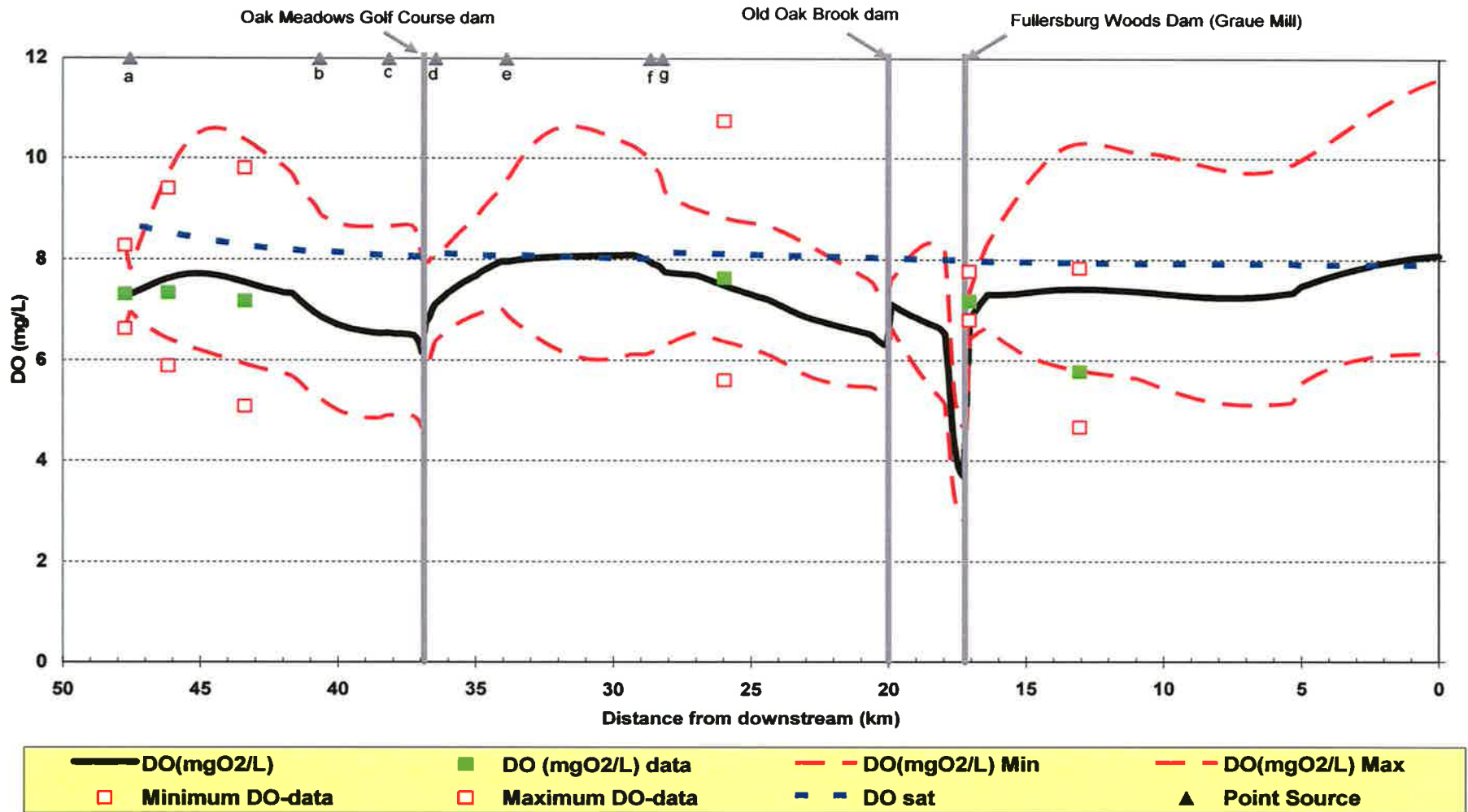
# ***Salt Creek (8/15/2006) Mainstem***

Monthly Average of June 2005 DMR Condition



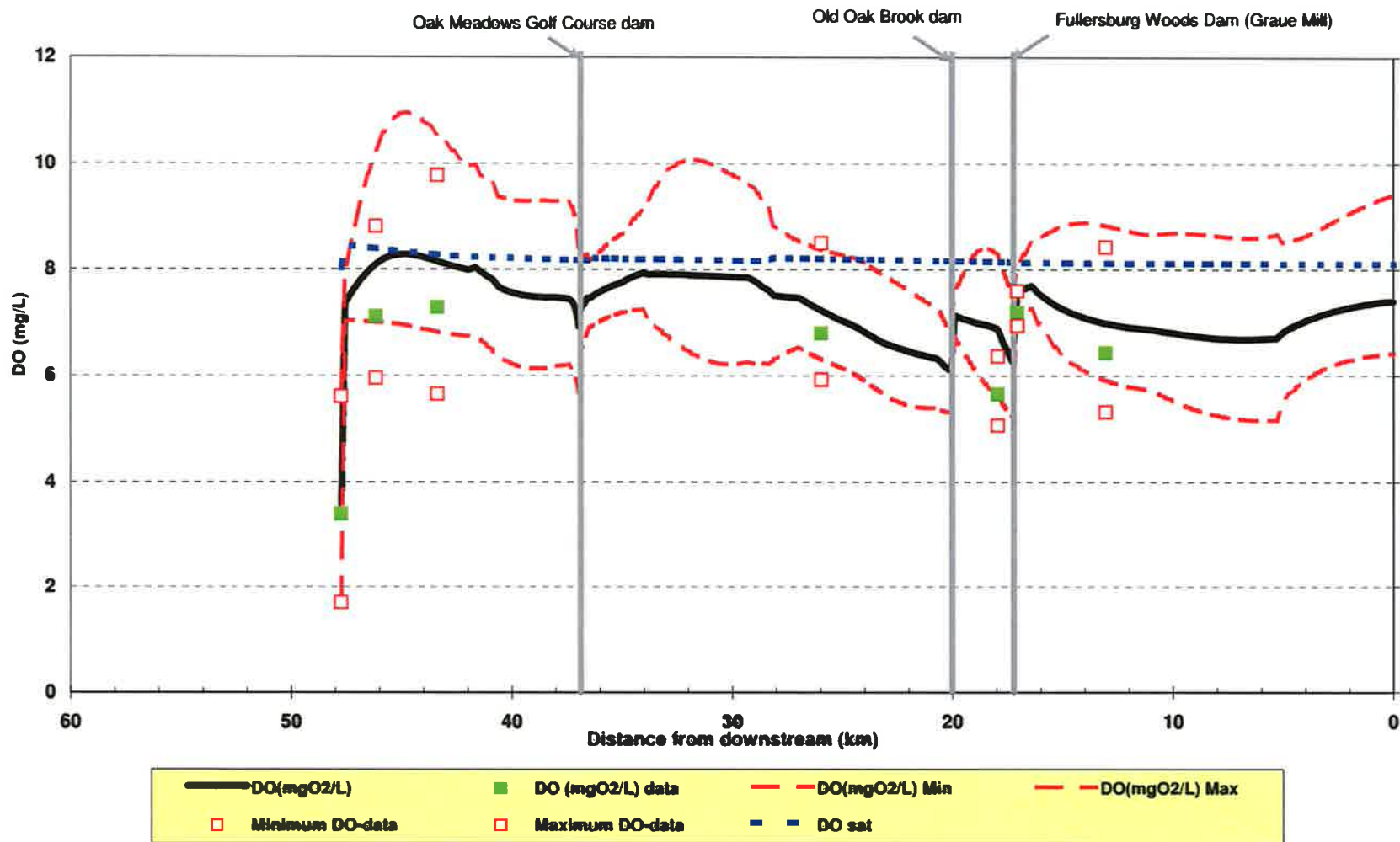
# Salt Creek (6/20/2006) Mainstem

Comparisons of Observed and Predicted Dissolved Oxygen: 2006 Validation Run (6/19/06 to 6/21/06)



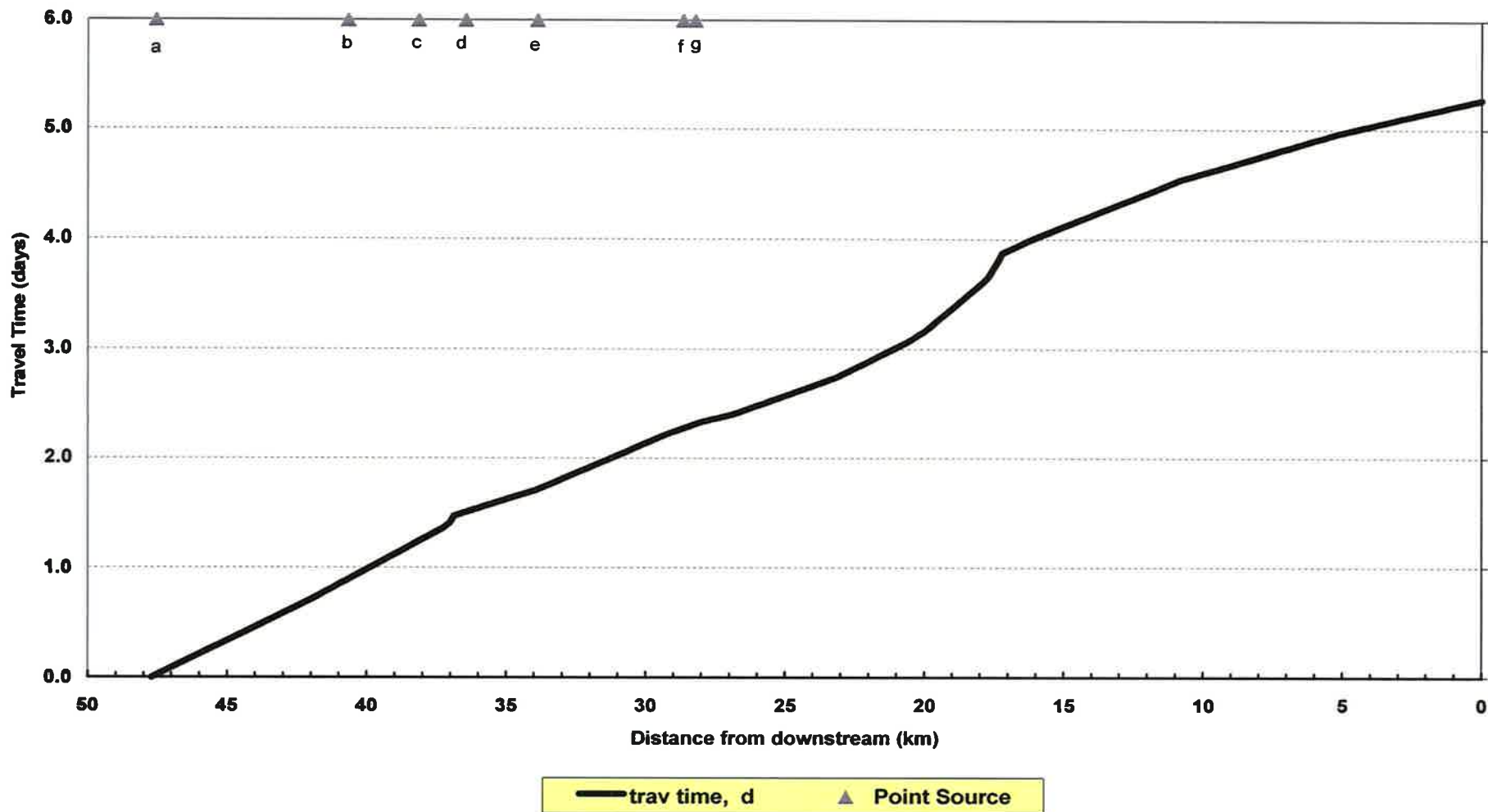
## Salt Creek

Comparisons of Observed and Predicted Dissolved Oxygen: Calibration Run (8/13/06 to 8/17/06)



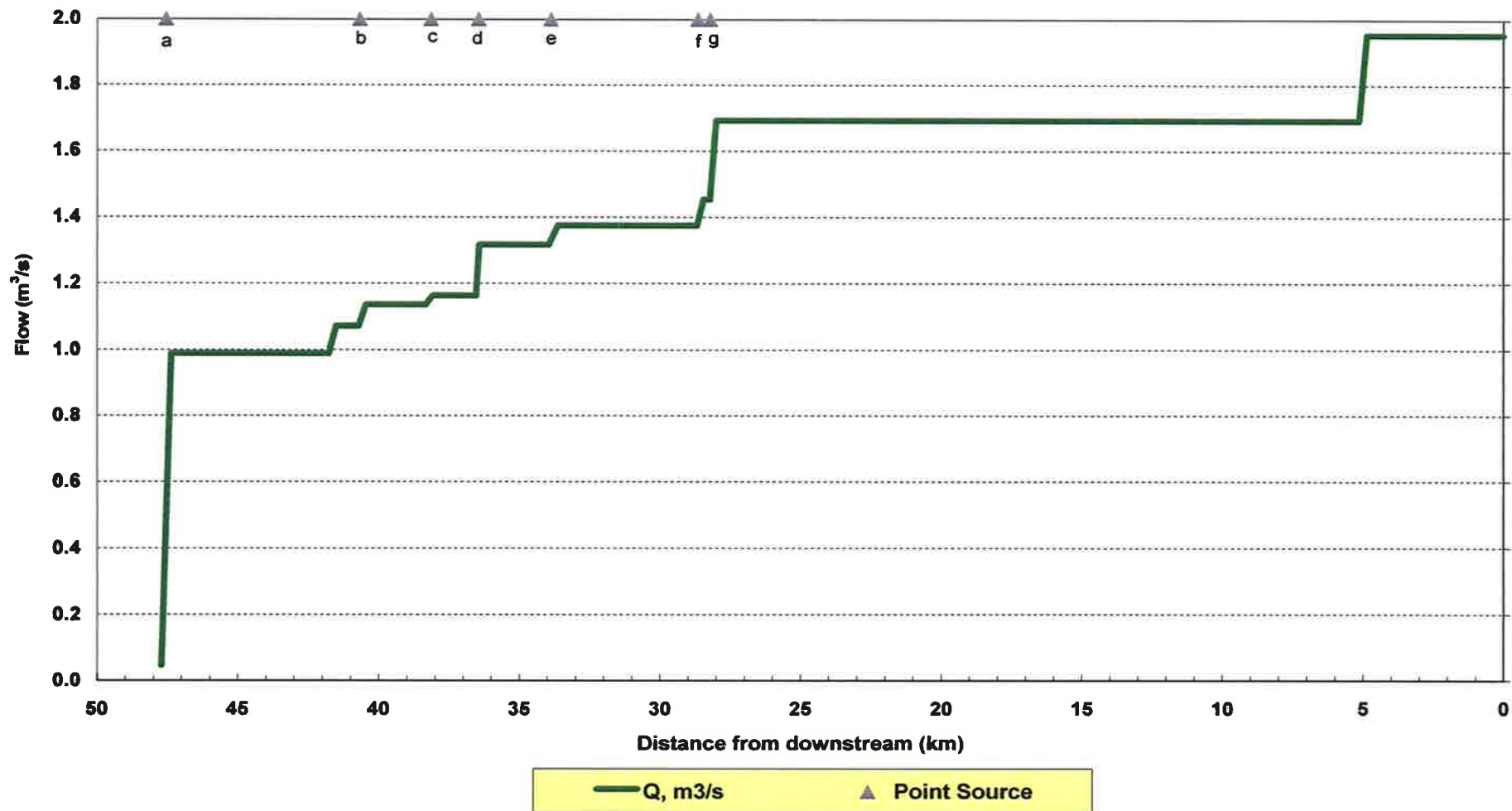
# Salt Creek (6/20/2006) Mainstem

Model Predicted Travel Time: 2006 Validation Run (6/19/06 to 6/21/06)



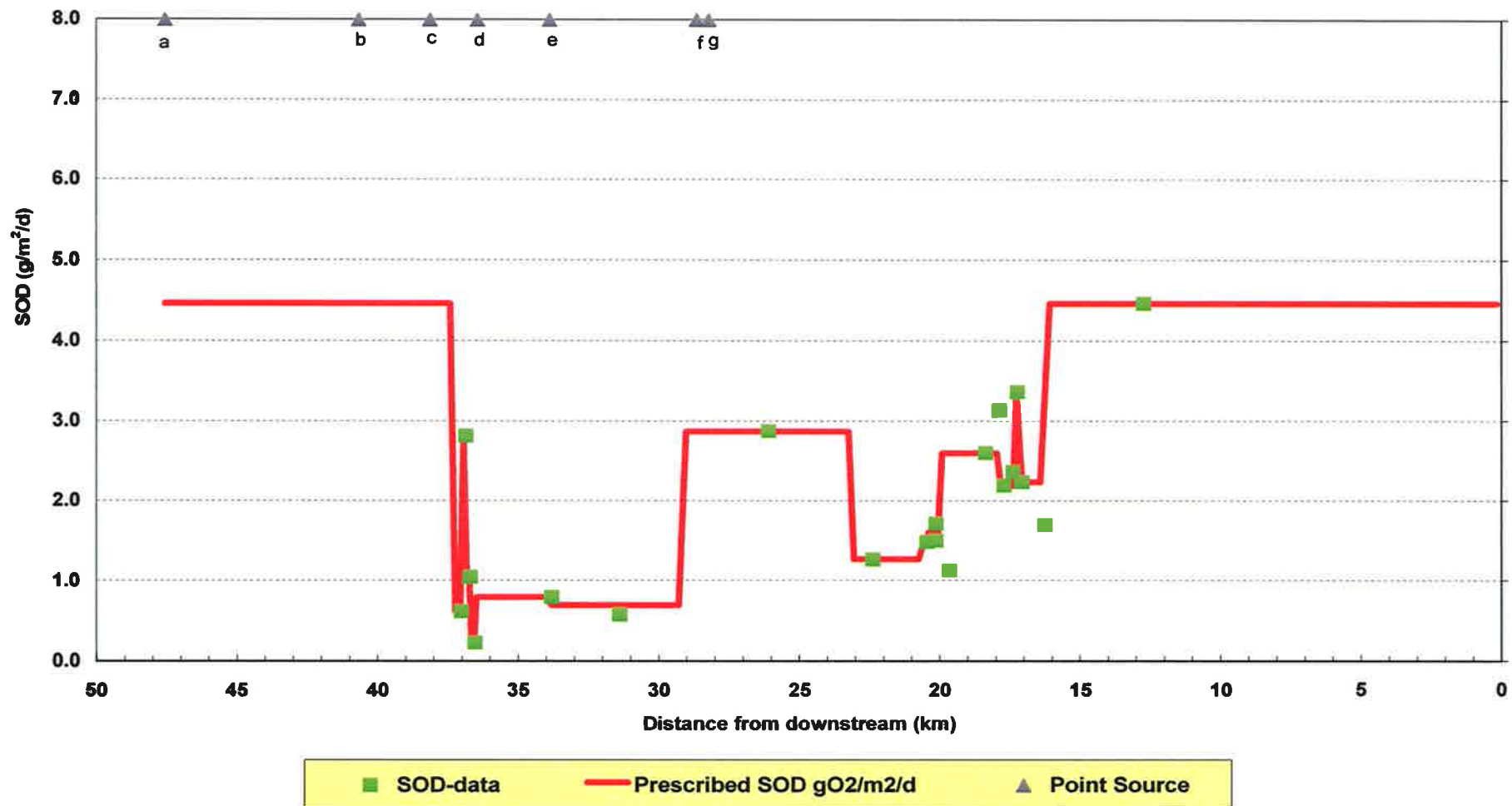
# Salt Creek (6/20/2006) Mainstem

Model Predicted Flow: 2006 Validation Run (6/19/06 to 6/21/06)



## Salt Creek (6/20/2006) Mainstem

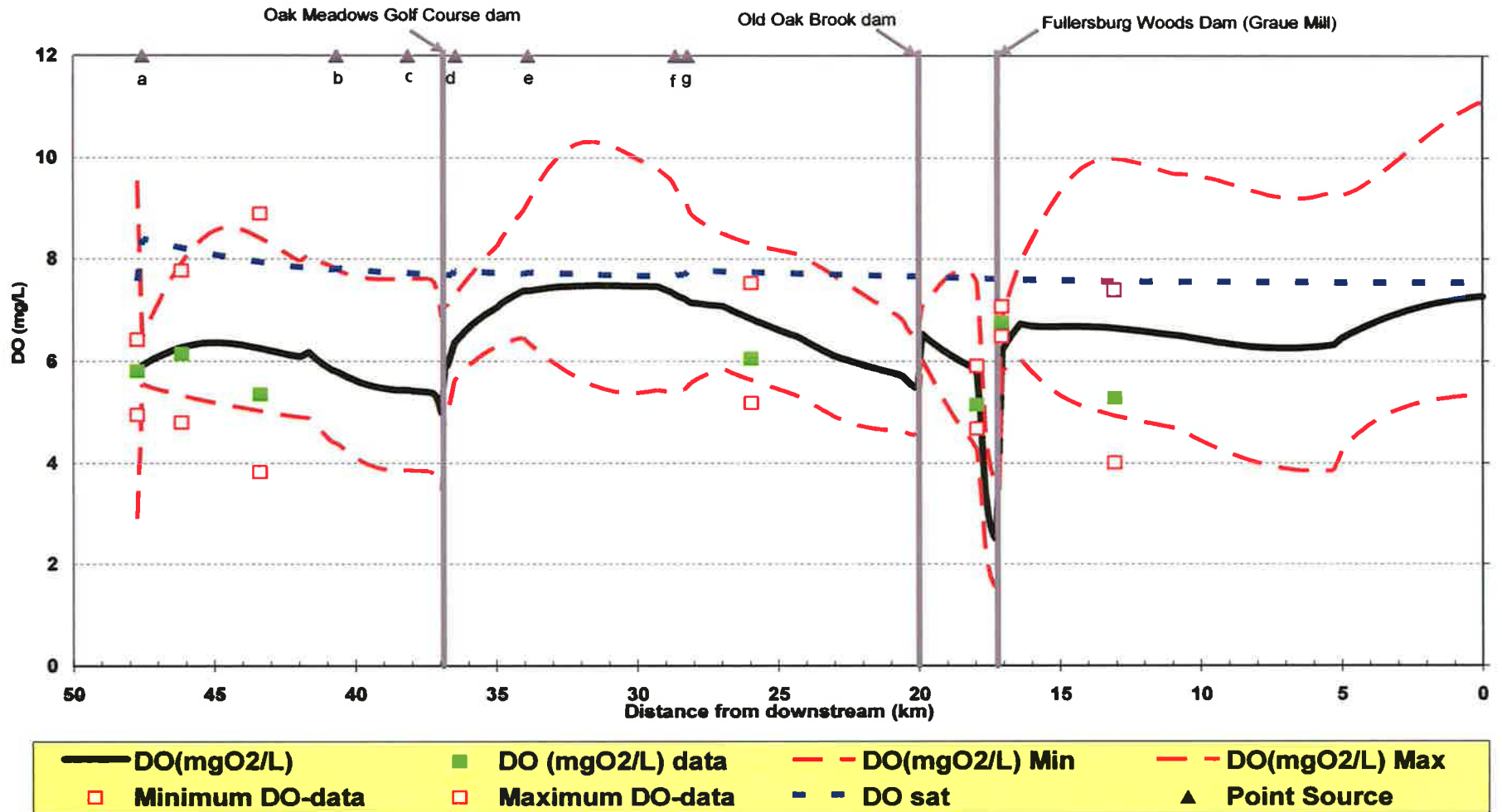
Model Input of Sediment Oxygen Demand (SOD): 2006 Validation Run (6/19/06 to 6/21/06)



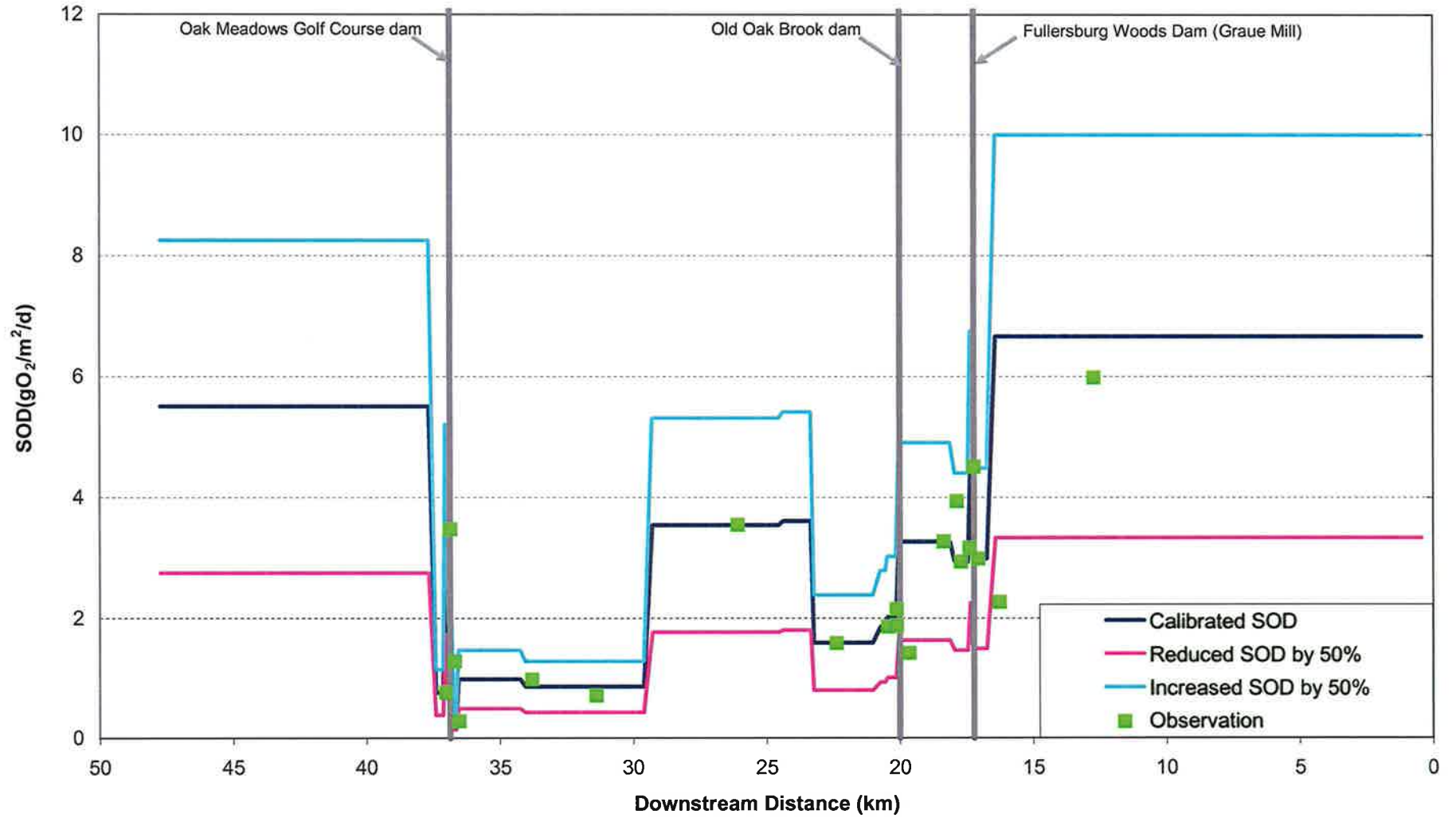


## ***Salt Creek (8/2/2007) Mainstem***

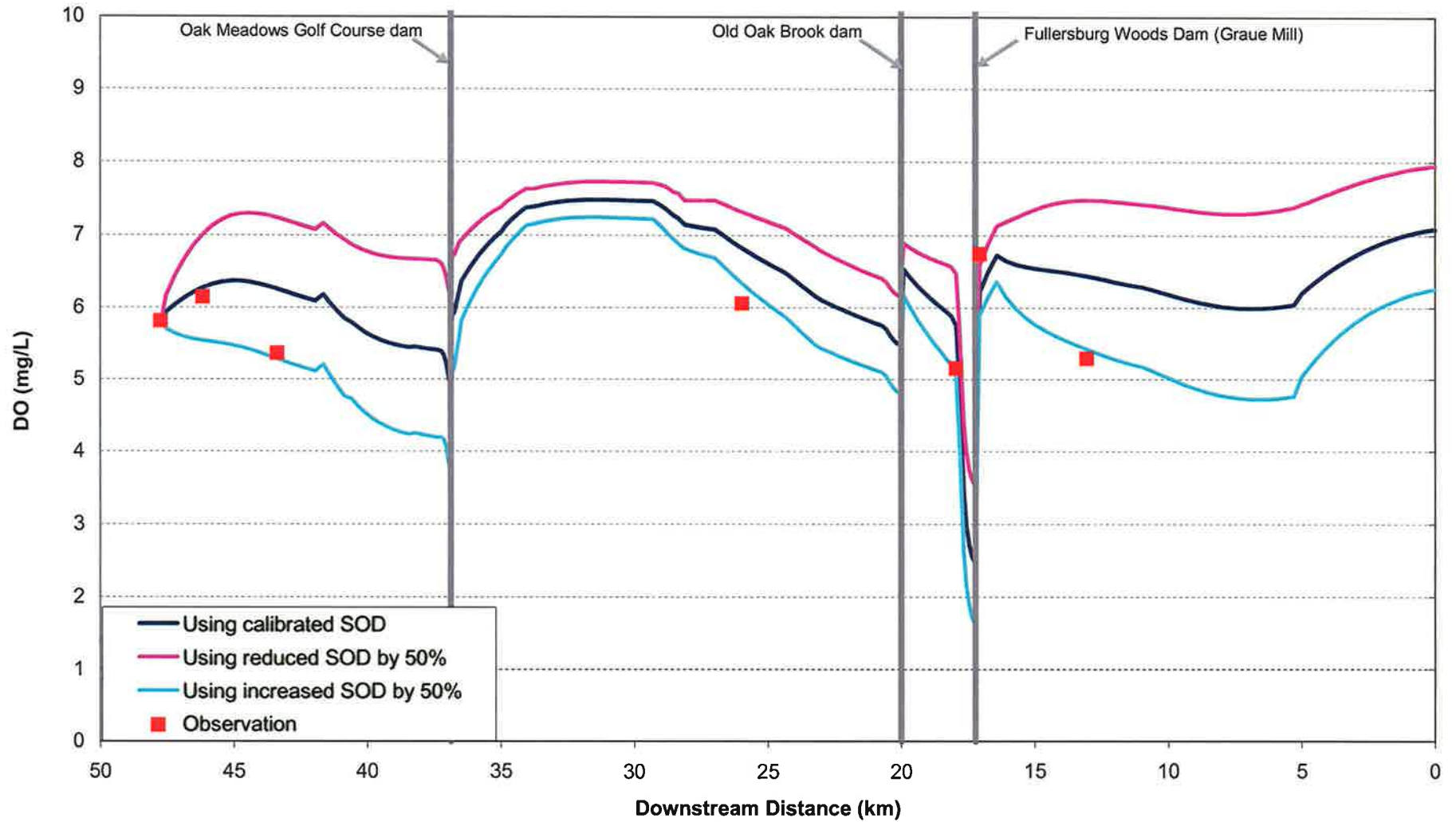
Comparisons of Observed and Predicted Dissolved Oxygen: 2007 Calibration Run



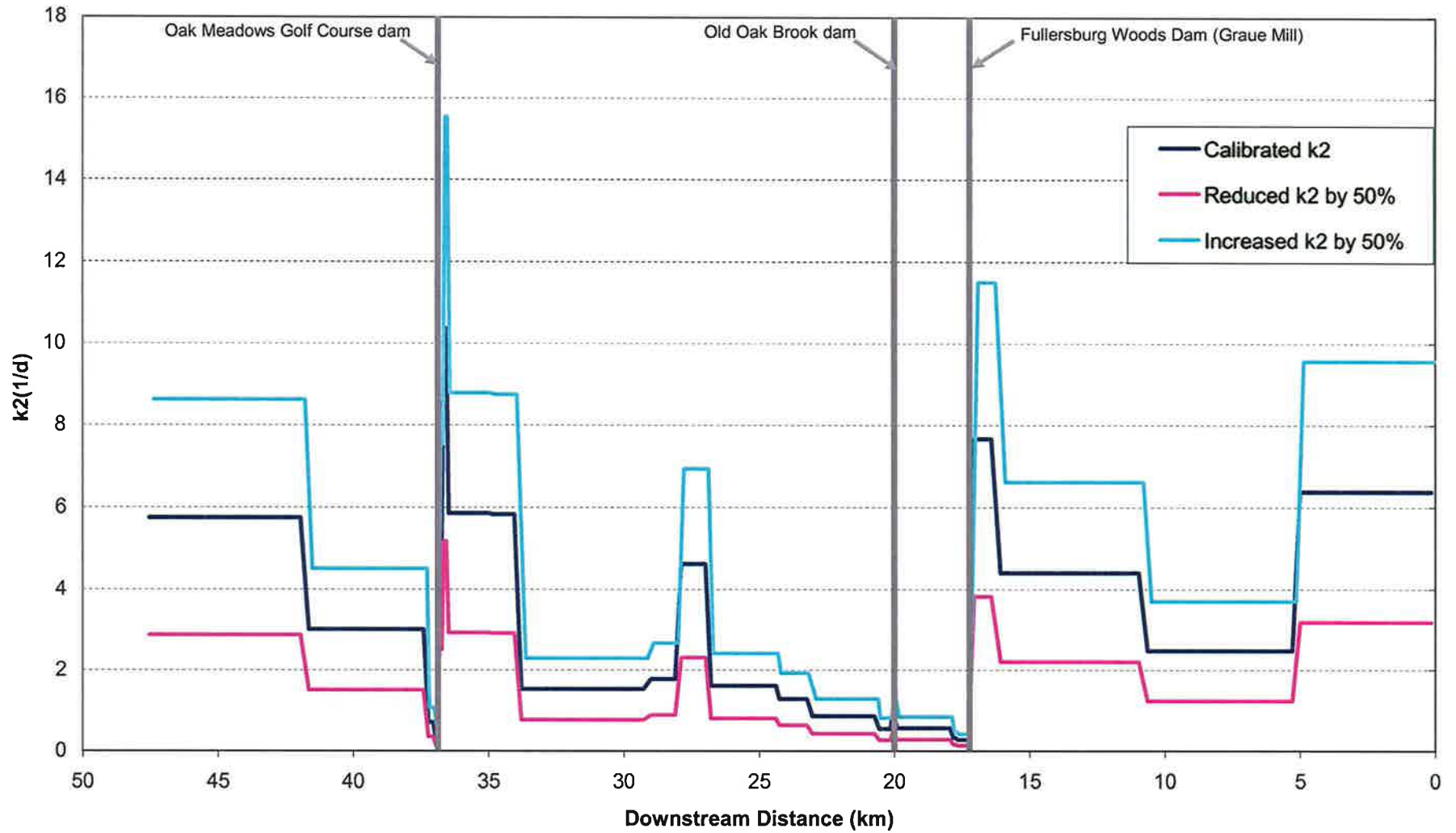
### Sensitivity Analysis: SOD SOD Input vs. Distance



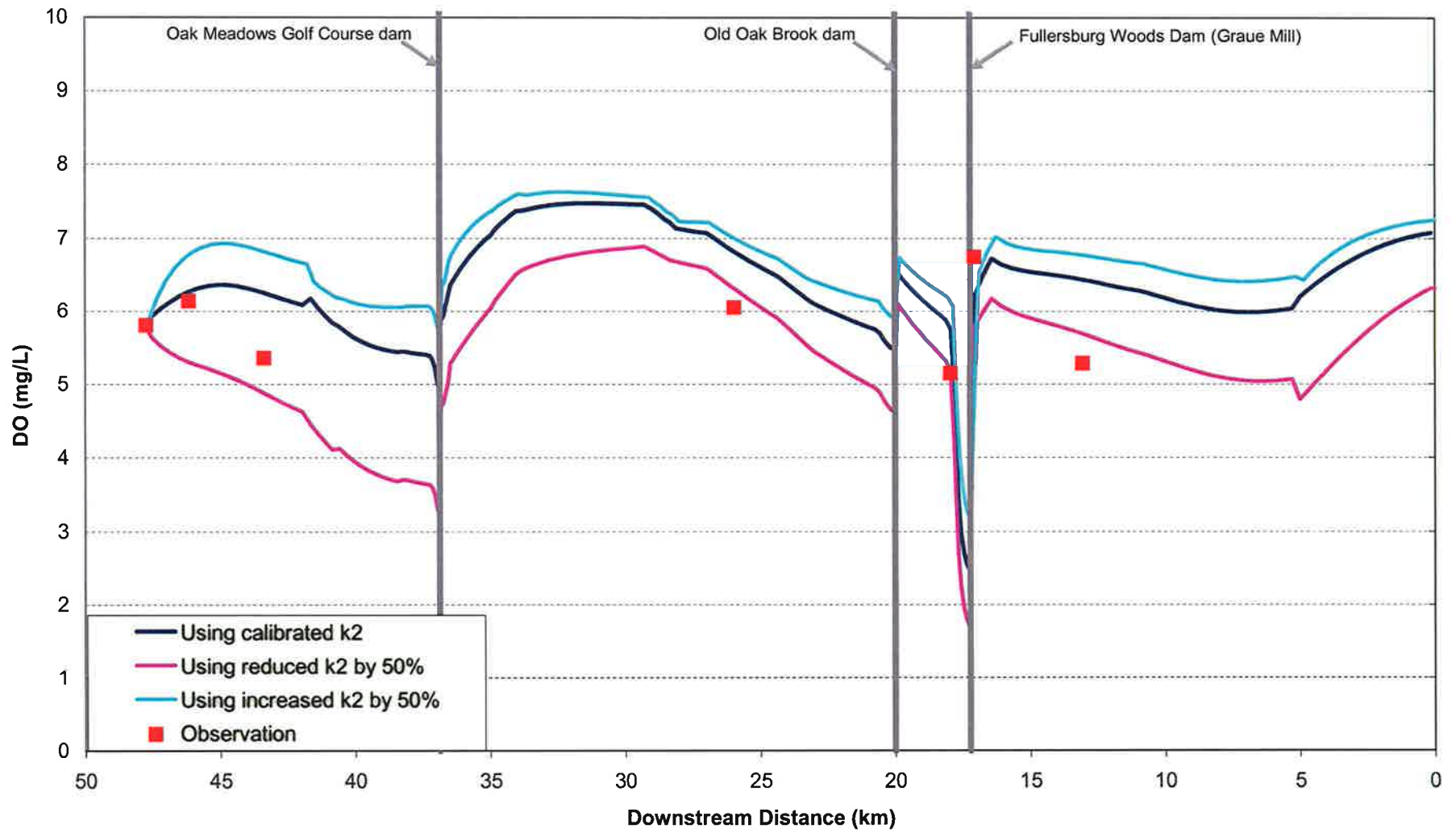
### Sensitivity Analysis: SOD Dissolved Oxygen vs. Distance



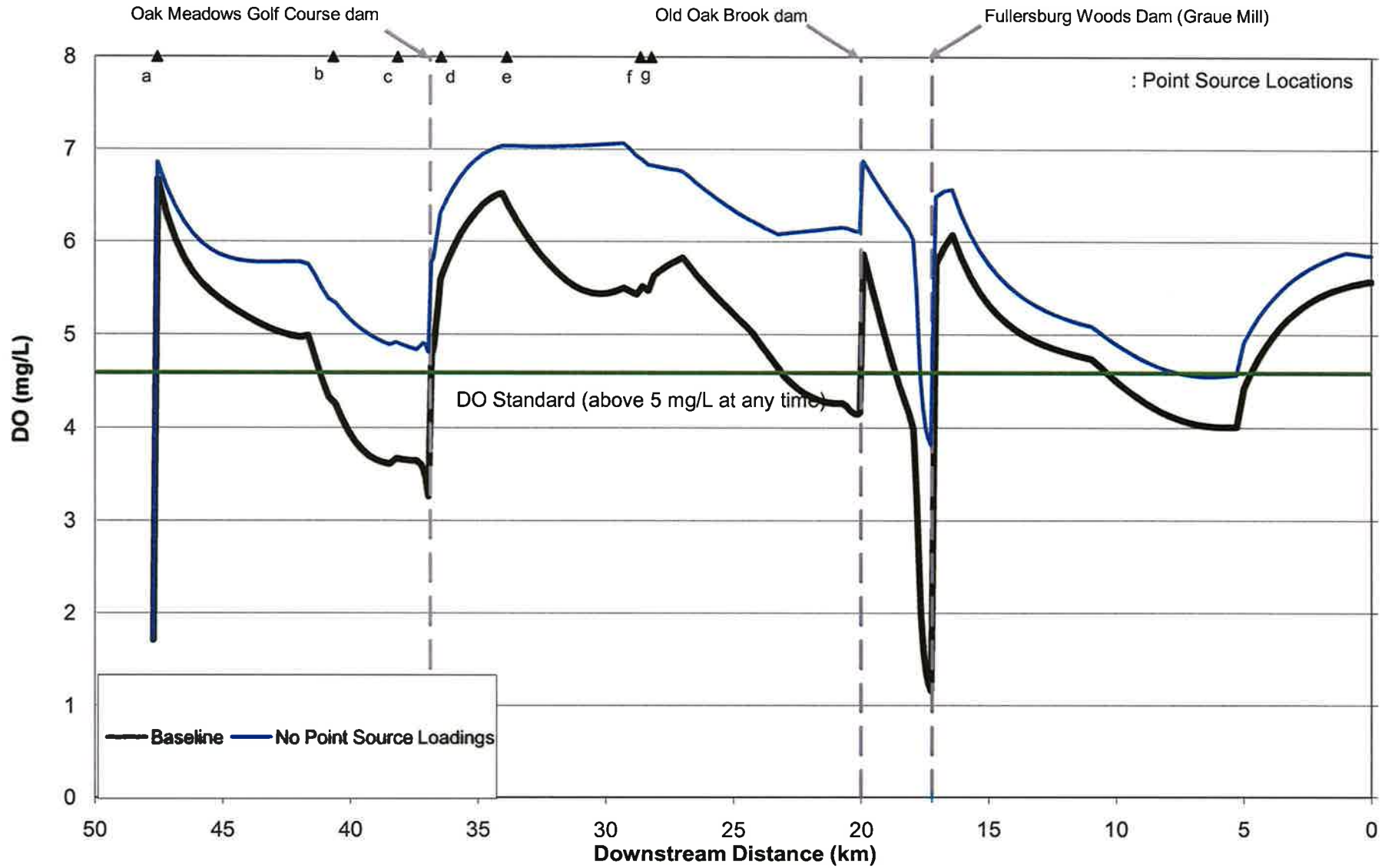
### Sensitivity Analysis: Reaeration rate, k2 k2 Input vs. Distance



### Sensitivity Analysis: Reaeration rate, $k_2$ Dissolved Oxygen vs. Distance

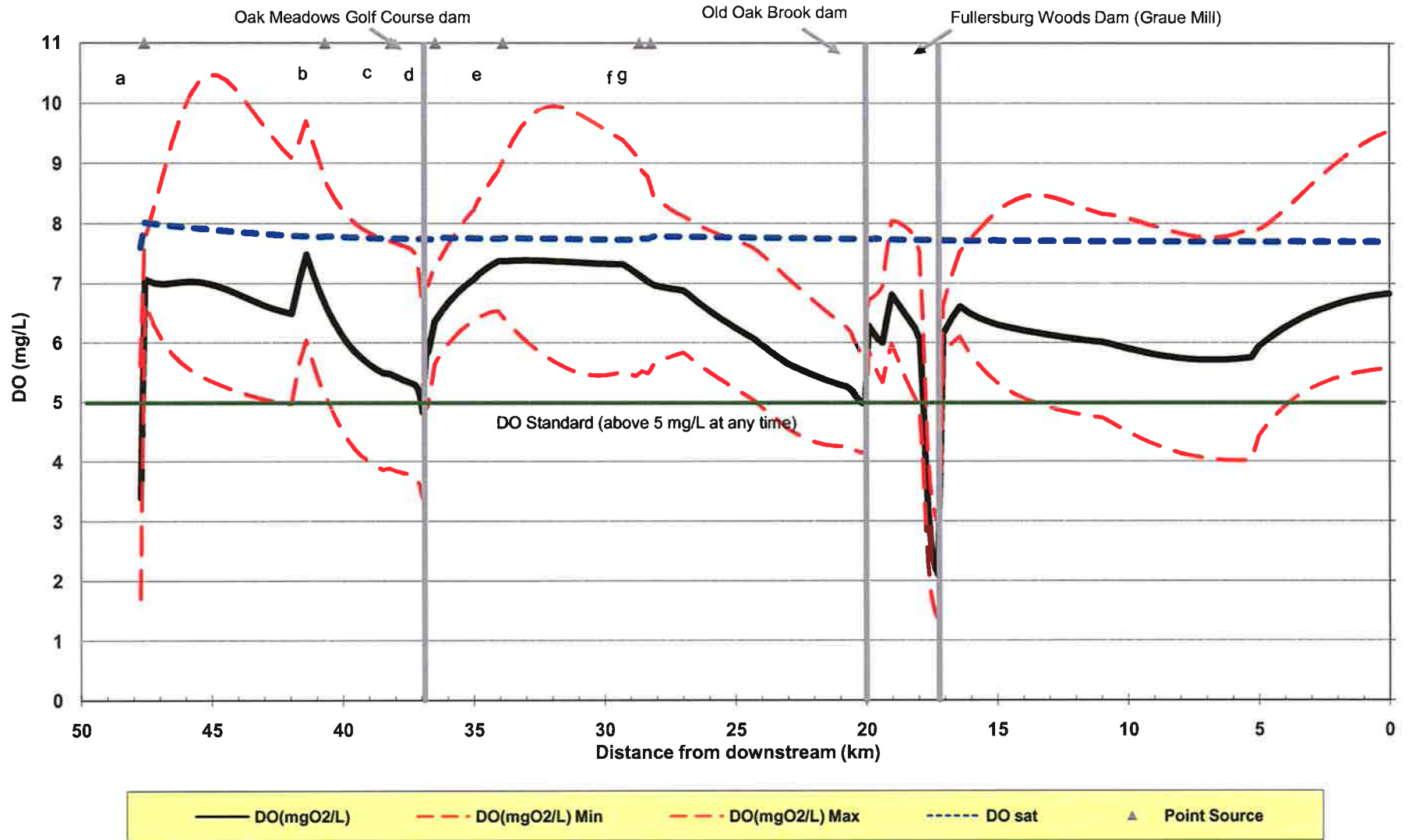


### Daily Minimum Dissolved Oxygen vs. Downstream Distance Evaluation Scenarios 1-No Pollutant Loading from POTWs



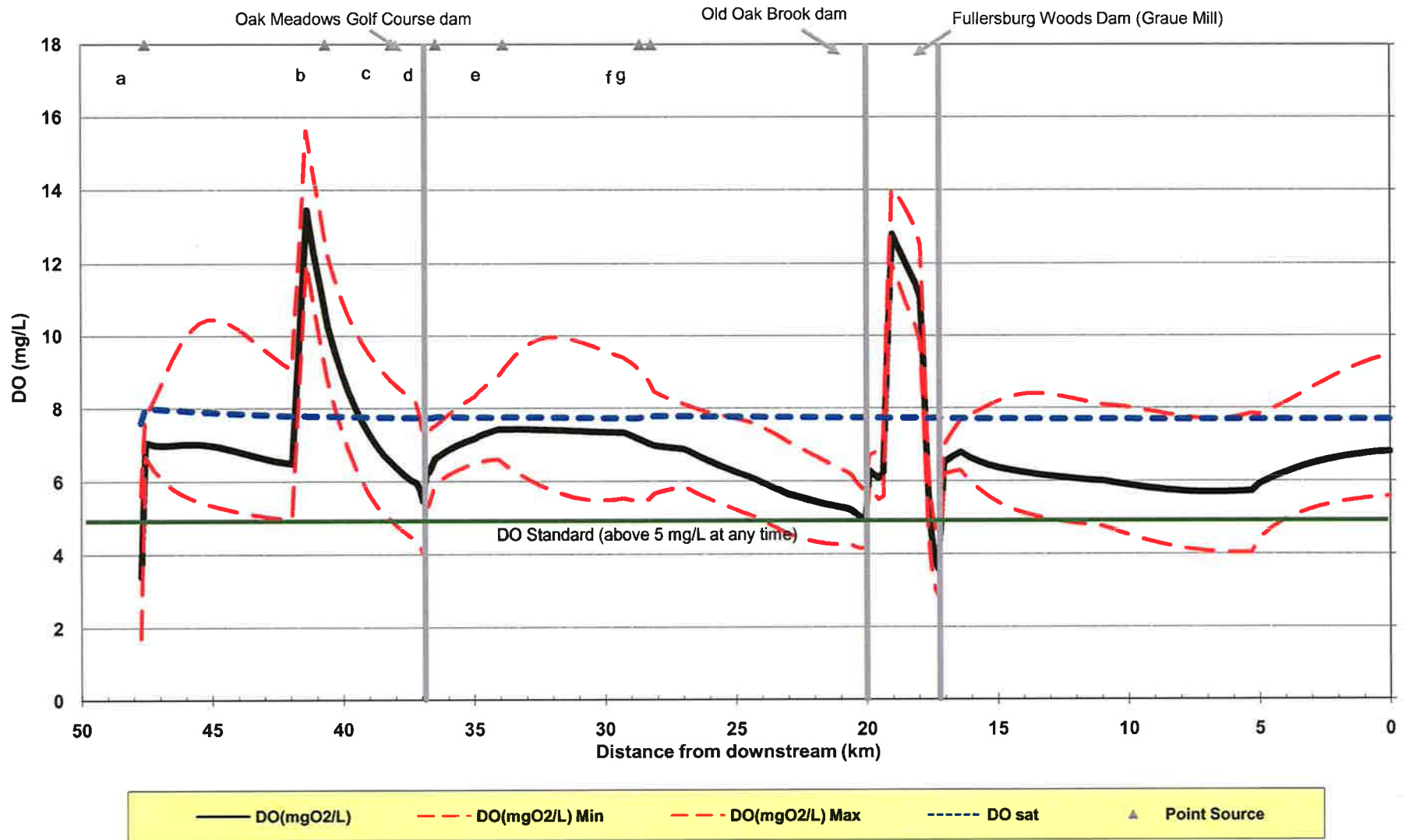
# Salt Creek (8/15/2006) Mainstem

## Aeration Alternative 3 in Oak Meadows Dam and Graue Mill Dam Impoundments



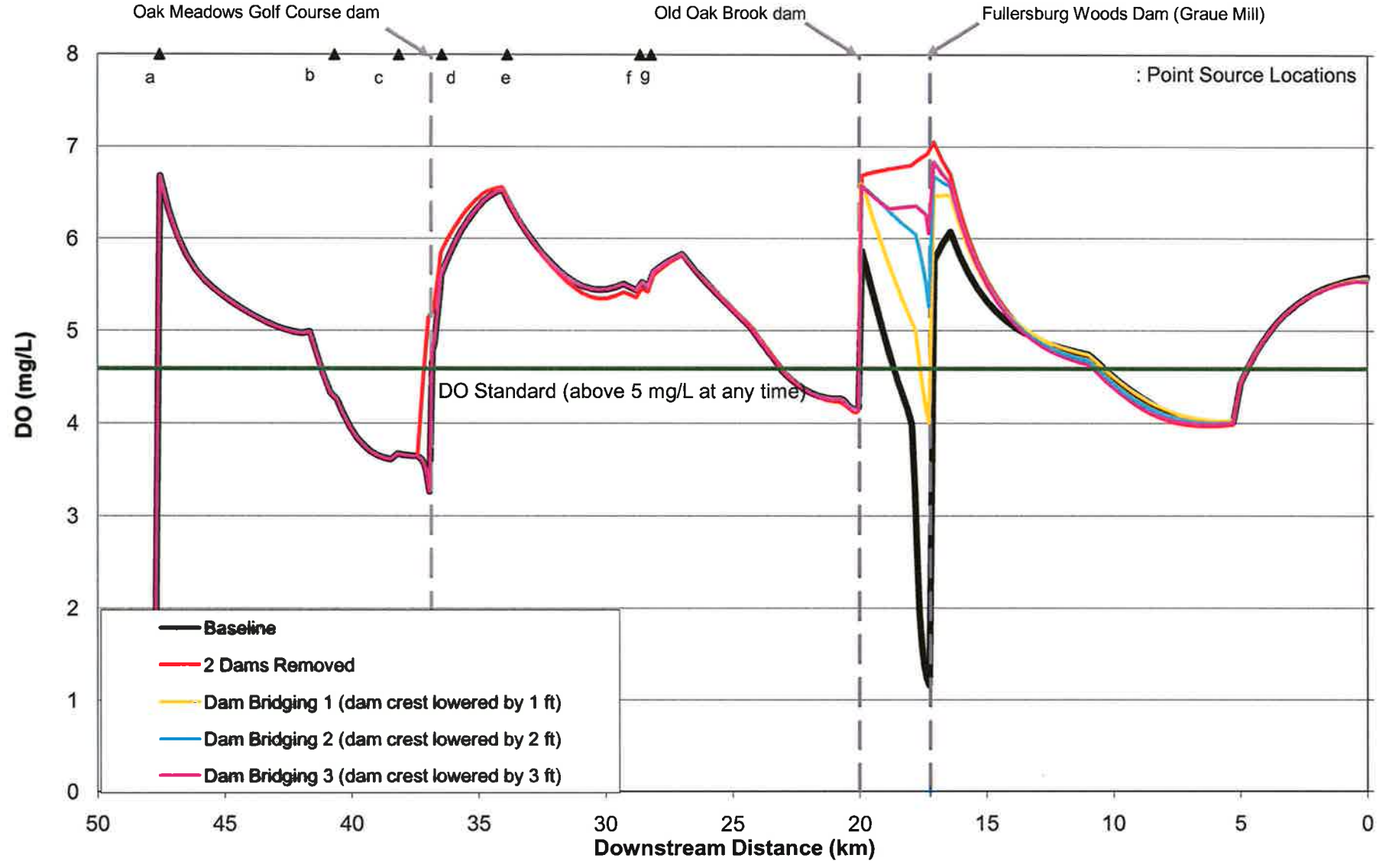
# Salt Creek (8/15/2006) Mainstem

Oxygen Addition Alternative 4 in Oak Meadows Dam and Graue Mill Dam Impoundments



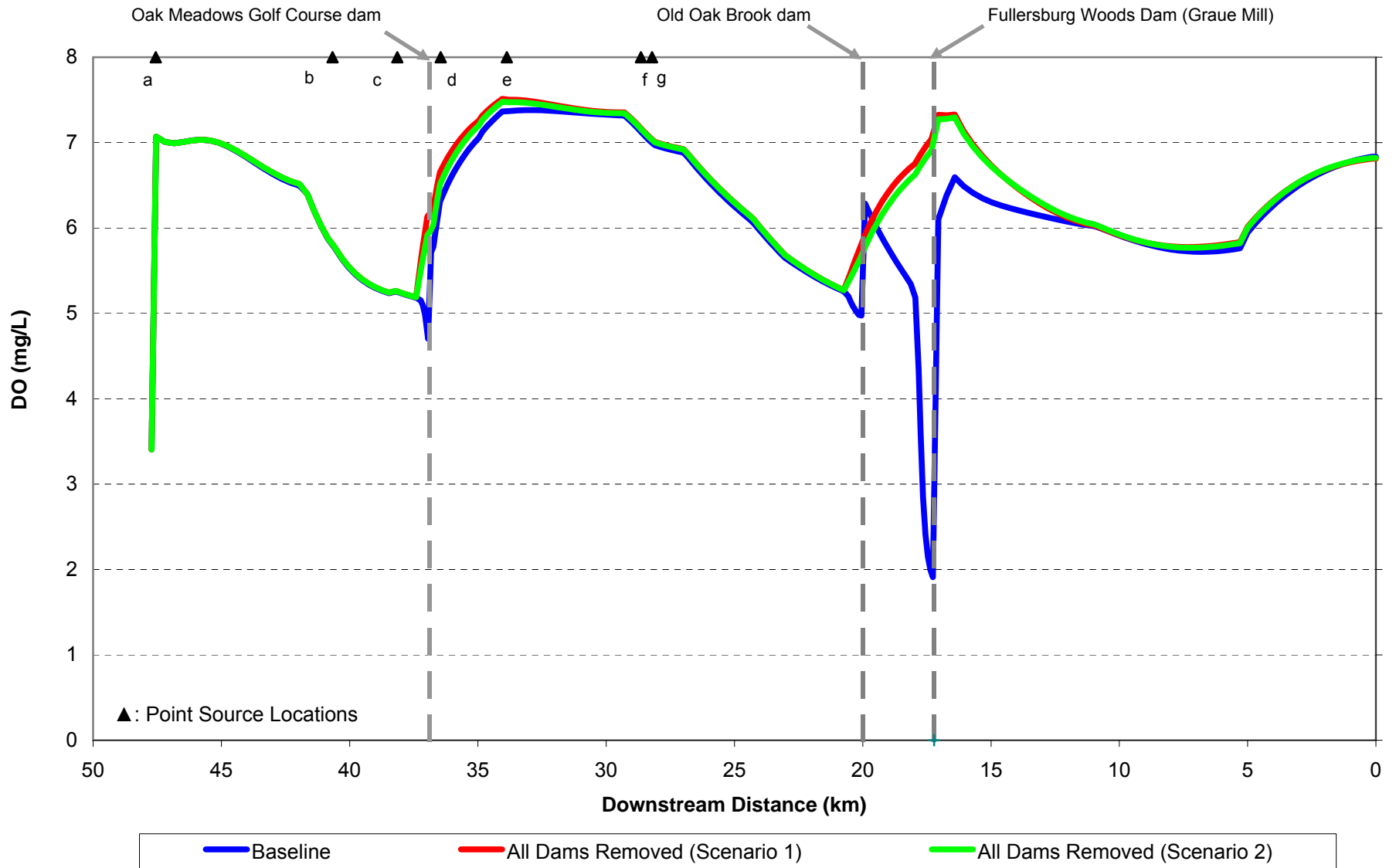


### Daily Minimum Dissolved Oxygen vs. Downstream Distance Evaluation Scenario 4-Dam Removal/Bridging



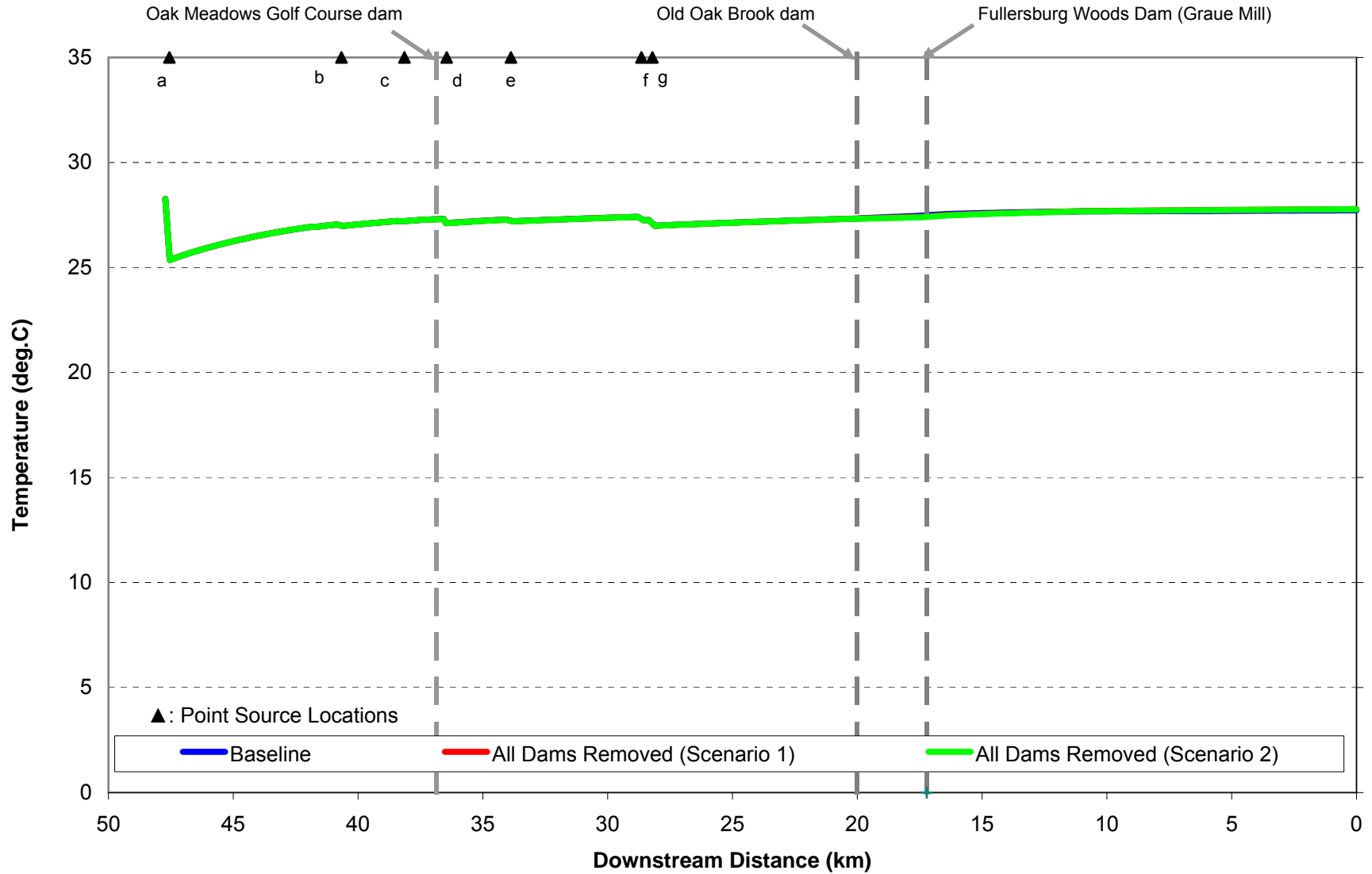
# Dissolved Oxygen vs. Downstream Distance

## All Dams Removed



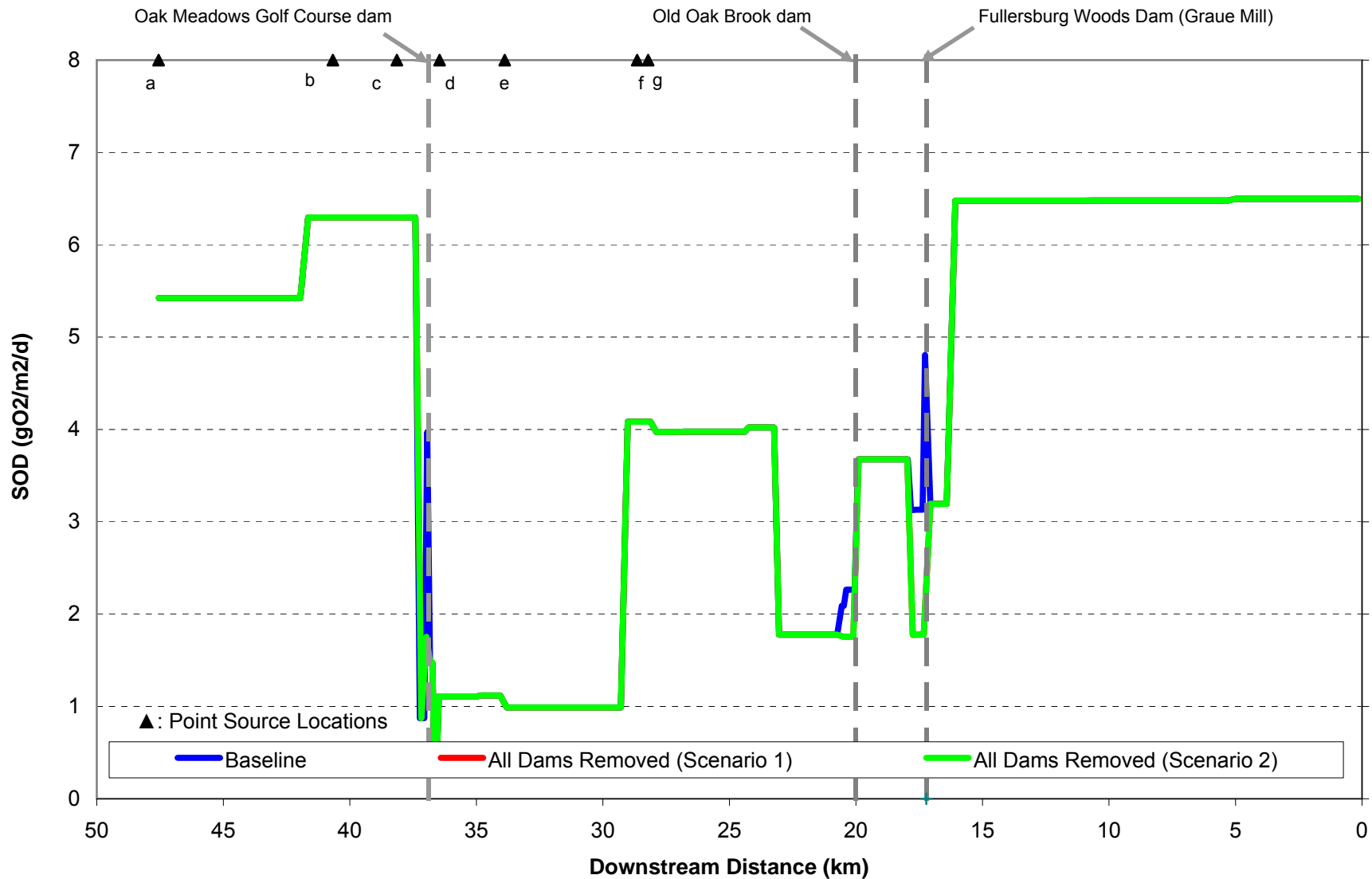
# Water Temperature vs. Downstream Distance

## All Dams Removed

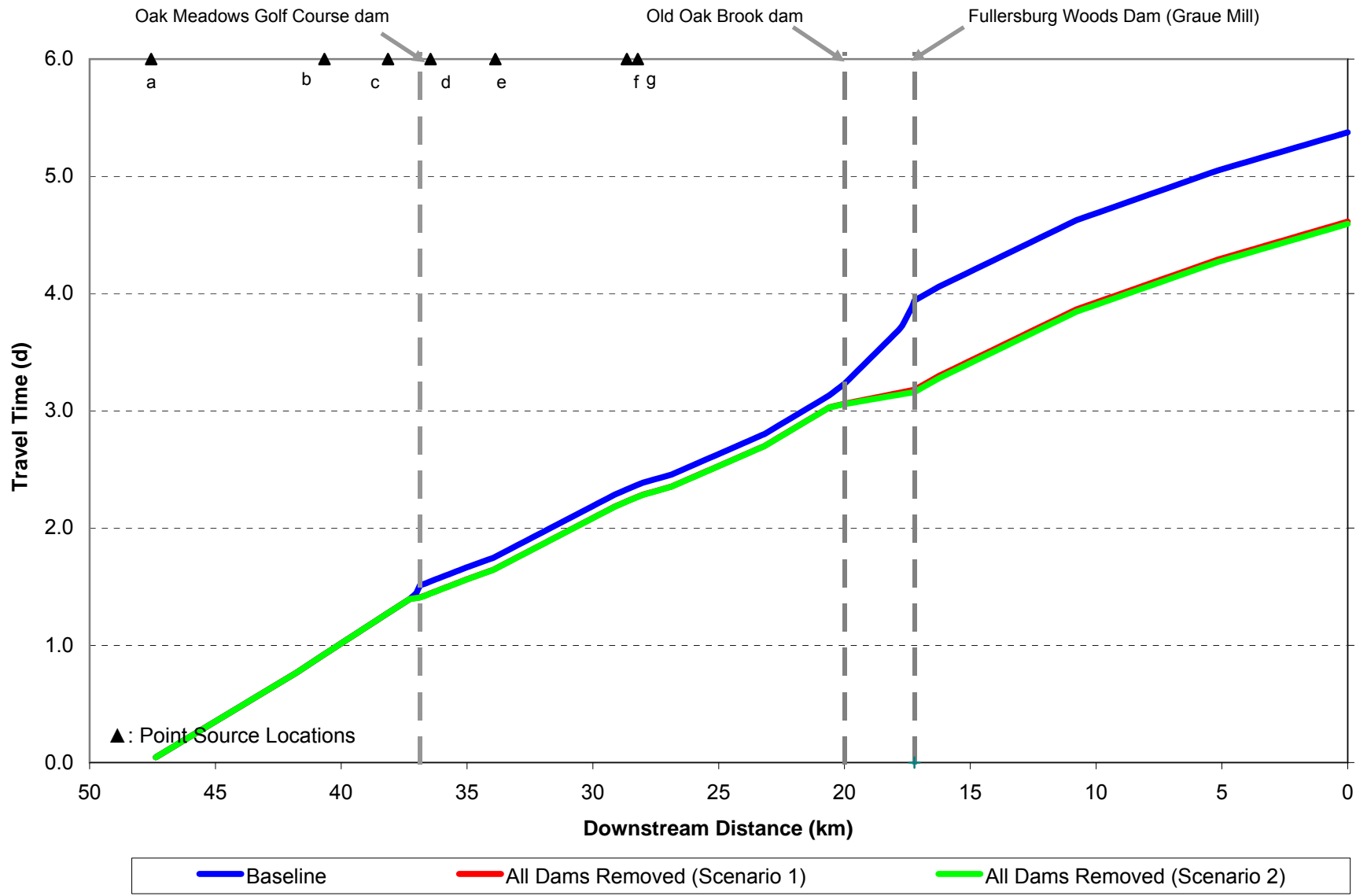


# Sediment Oxygen Demand vs. Downstream Distance

## All Dams Removed

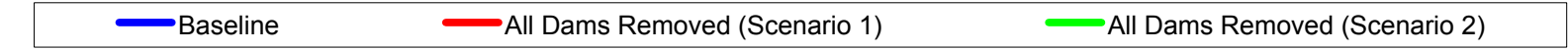
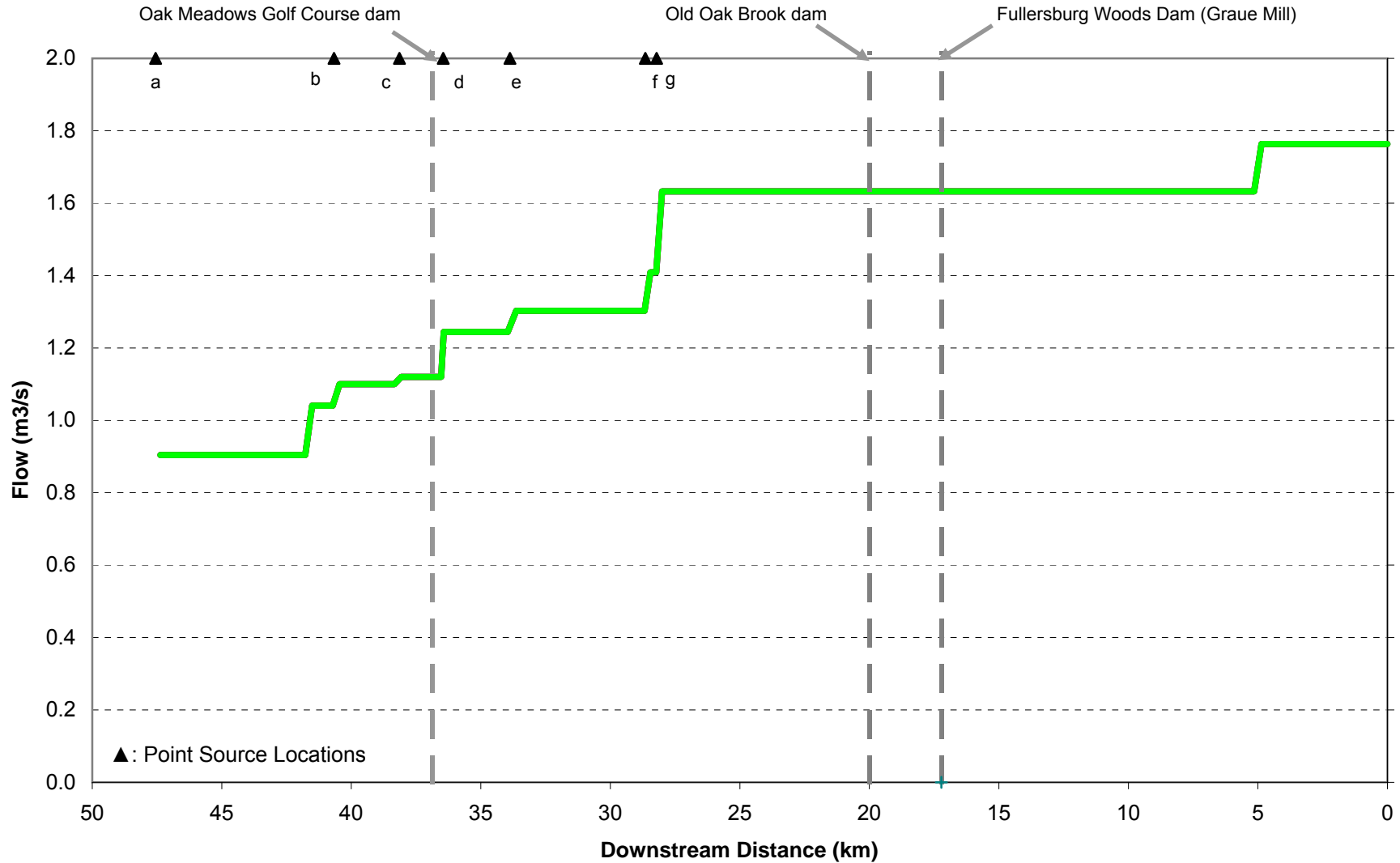


### Travel Time vs. Downstream Distance All Dams Removed



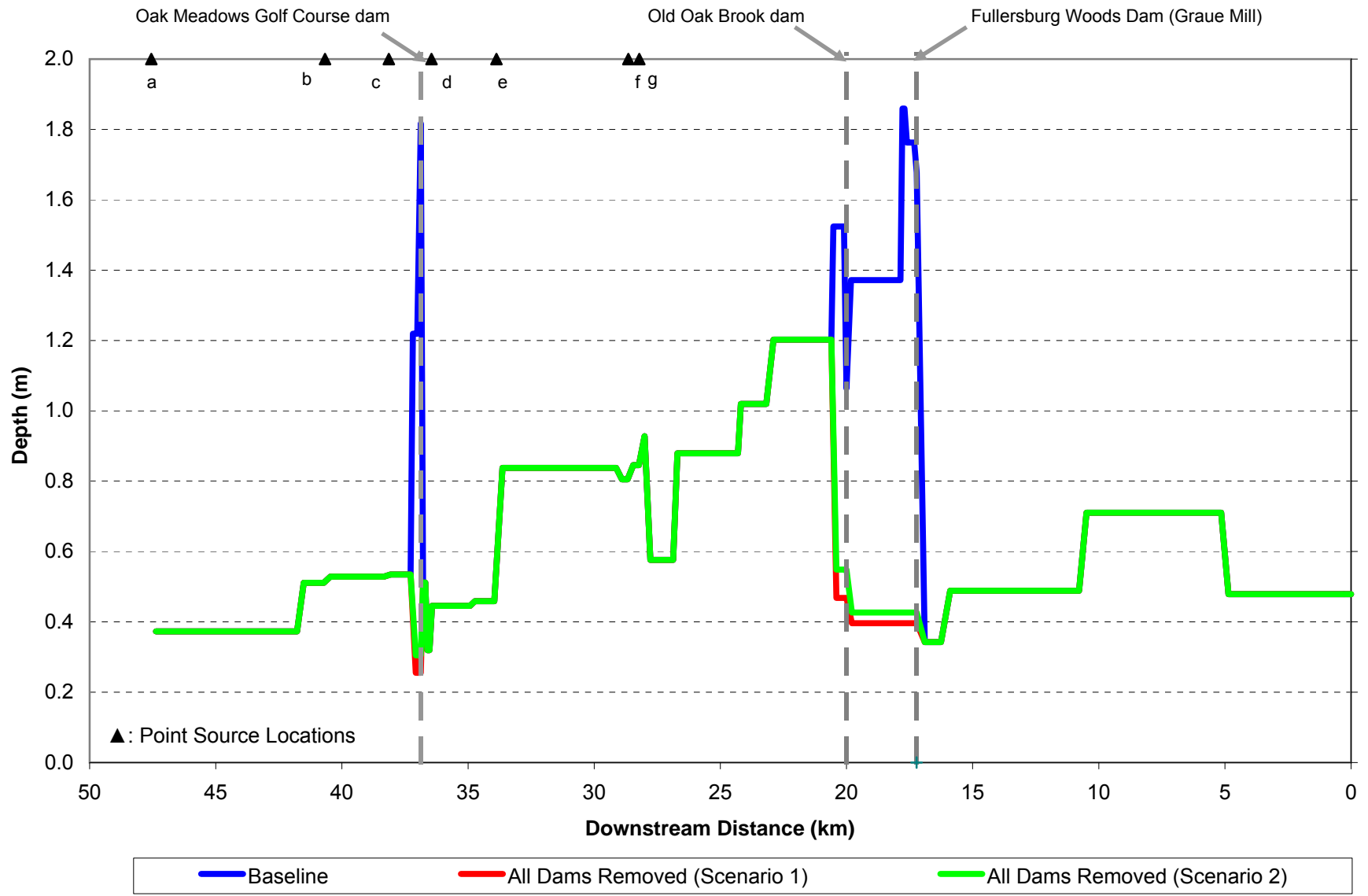
# Flow vs. Downstream Distance

## All Dams Removed

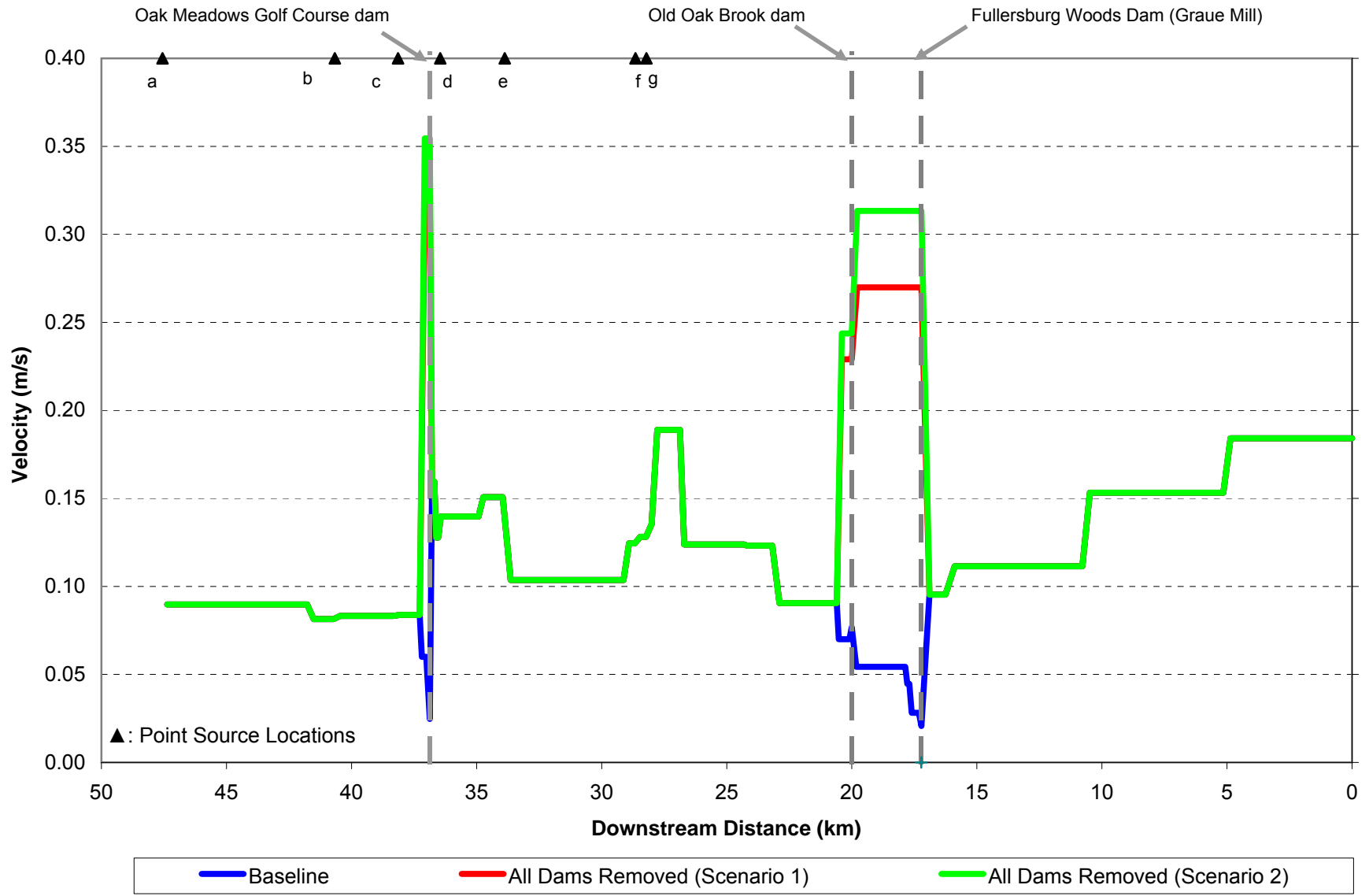


# Water Depth vs. Downstream Distance

## All Dams Removed



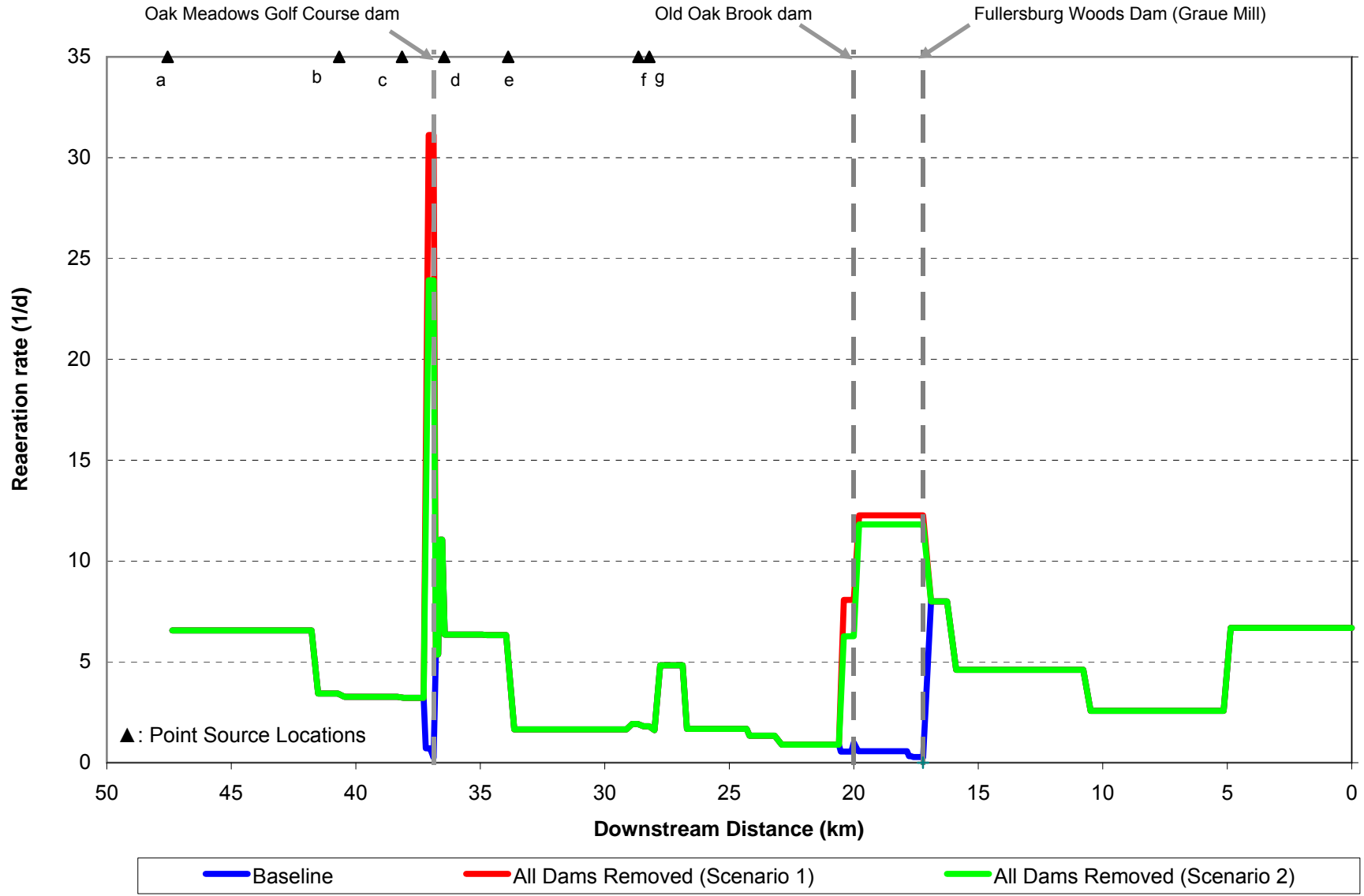
### Velocity vs. Downstream Distance All Dams Removed





# Reaeration Rate vs. Downstream Distance

## All Dams Removed



# Appendix D

**Appendix D. Summary of Comments made during public meeting outlining the findings and recommendations if the DO Study Report for Salt Creek.**

**Meeting 1. 7.30 PM Oak Brook Village Hall. 03.18.2009. Number of attendees 44**

Comments: (*Italicized are hosts answers*)

**Public Comments**

Two solutions were proposed, the second was not clear.

1. *Bridging or ramping*
2. *Partial Breach - water not over the top of the dam unless auxiliary pumping*

Will there be a concrete apron installed with the breaching option?

*There would be a natural scour pool. There would not be an apron installed, perhaps there would be buttressing of the dam.*

Scour pool is a bad term; it implies sediment in my backyard.

*Erosion cannot increase under the regulations.*

What was the cost of dredging when completed previously?

*\$500,000-600,000 in 1995 dollars*

Can aeration be created any other way?

*Bridging, riffles and artificial aeration*

Can riffles be used upstream of the dam?

*No, a change in elevation is needed; it can't be done in a flooded area*

What would the bridging option look like?

*The crest would go down, ramp created on the downstream side.*

Would there be water flowing over the dam?

*Yes, but part of the dam would have to be removed to achieve the DO standard, the fall would be smaller than at present*

What would it look like upstream in the bridging option?

*Look at diagram – pink shows where the water level would be if the crest was decreased by one foot. The aqua shows two feet. The yellow shows three feet. The channel will narrow with the bridging option.*

Committee member is disappointed with the context, the colors are bad, the slides are different, the committee met four times and they had not seen this graphic. Gates were put in at the dam to make it a flood control structure. When the gates are open the upstream channel recedes to 35 feet wide, can't see it from Spring Road. Vegetation will impede the flow of water when flooding.

*Under no circumstances will any part of this project make flooding worse. Trees slowing down flow more than offset by increased storage? Bath tub example. The reservoir will be empty so additional capacity is created.*

If the sediment decomposing take DO wont dredging help?

*Sediment is constantly being added and even a fine layer will trigger oxygen consumption. No re-aeration in pool.*

Treatment plants add sediment at storm time.

*Treatment plants have constant flows. If we do activity and do not meet the DO goal, IEPA will come back and say do more, this is not an attempt to draw attention away from POTWs*

There was a request for three dimensional models.

*That would be cost prohibitive and would not add to the understanding of the problems or potential solutions.*

How does the mill race continue to flow if the dam is taken down three feet? If the dewatering gates are open the raceway is dry.

*There are a number of ways to accomplish this, how it will be accomplished exactly hasn't been decided. Needs to be discussed with mill operators. It can, and should be, engineered to continue to flow.*

Are there any threatened or endangered species at the site? If there are no threatened and endangered species, it's not that critical of a problem.

*No, there have not been any threatened or endangered species identified on site because the habitat and water chemistry are so degraded that they can not support threatened or endangered species. The habitat will not support even common species.*

A microphone should be on hand.

*There will be one at the March 31<sup>st</sup> meeting.*

Concerned because the character of the mill area will be changed, lose the beauty of the area – artists, photographers, families come. There are 20,000 visitors a year.

This is the only place where we have a historic dam that dates back to the 1830s.

*The Clean Water Act does not allow for exemptions, we are looking for a balance between the history and water quality improvements.*

How can the historic integrity of the site be maintained if water does not flow over the dam?

Where is EPA? What can we do? Who do we contact beyond this meeting?

*IEPA's solution is to go to treatment plants, but that costs money and won't meet the stated environmental goals. We would still have impairment on the waterway even under optimal plant upgrades. We have two options, dam modification and aeration. We discarded aeration because it doesn't solve the habitat problems and it is expensive. Aeration scenarios were examined, four different options that resulted in the following 1) very expensive equipment 2) costly maintenance 3) no one to maintain and operate 4) where to locate the equipment. If ever treatment plant puts out drinking water quality effluent, the problem is not solved.*

What about the two bridges above the dam?

*It was clarified that the question was referring to additional dams shown above Graue Mill. Oak Meadows is owned by the Forest Preserve District and will be addressed – likely removed. The Old Oak Brook Dam is not causing a major problem. We have taken the worst problem on the waterway and made it a priority project. Then we will monitor to see if the problem is solved.*

Are we going to destroy Graue Mill so we can take of one mile of Salt Creek?

*All indicators show that area at Graue Mill is one of the largest water quality problems on Salt Creek.*

I live downstream, what will happen to the water? There's quite a bit of flooding now.

*The dam creates no storage so both options will cause no increase in flooding. The DuPage County Ordinance does not allow for an increase in flooding.*

Do dewatering gates exist at the dam?

Yes.

Can we open the bridge and see if it improves DO?

*It was noted that the question refers to the dewatering gates, not a bridge. The Forest Preserve District operates the gates and has said that they are insufficient to dewater the impoundment. They clog with woody debris. The Forest Preserve District does not want to routinely clean the gates. The dewatering gates have approximately half the capacity of what is being proposed. Option should be examined more closely and had come up at the DRSCW working committee on DO*

Both options for altering Graue Mill dam will not preserve the historical aspect. The aesthetics will be destroyed. Wedding parties are there every weekend. Painters paint the waterfall. The water flowing over the dam is an aeration system. He's appalled that we have a government that is worried about marginal affects.

*To us, and a number of other groups such issues are not small but essential. Environmental agencies will sue if the solutions do not have enough of an environmental effect.*

Commentor has been on the Salt Creek Committee. She was the Vice Chair of the DuPage County Stormwater Commission. She was around for the flood of 1987. The DuPage County Stormwater Committee is the only one licensed by the Corps of Engineers to operate on their behalf. They would lose that if they allowed flooding to be exacerbated downstream. It's important for residents to negotiate out a good answer. IEPA answers to USEPA, they hold all the cards. We need to collaborate to come up with a reasonable solution.

### **In Person Comments**

If water flow in raceway can be maintained project look like fair compromises

Presenter knows nothing of history and is biased

It is understood that area upstream is essentially dead (devoid of life)

Previous skepticism of project largely assuaged

Very interesting presentation

Maintaining flow in race way is key

### **Comment Box:**

Fishable/swimmable?

It won't help to alleviate the sediment problems or remove the dams if the dumping of raw sewage continues in Fullersburg Woods from the Hinsdale Sanitary Sewers (Flagg Creek POTW).

**Meeting 2. 7.30 PM Oak Brook Village Hall. 03.31.2009. Number of attendees 60**

Comments:

Speaker from the Dullersburg Homeowners Association 550 homes, personal observations. Moved here with wife 58 years ago. His home was built in 1874, one of the only structures here that is that old including the dam, the York grocery store. He thinks this is heritage vs. fish. He doesn't know where the swimming concept came from. He is an environmentalist, but you have to draw the line somewhere. Oakbrook is the jewel of DuPage County. It has eight historical buildings. He doesn't know the distinction between a creek or a river. The creek is an essential part of the character of Oakbrook. The vegetation will grow up and encroach and the creek will disappear visually. Are we here to support the fish downstream? Solution is to reexamine dredging in phases and discovery. There is no doubt that we could get grants. If dredging doesn't meet the criteria perhaps breaching. He wants to start group. Has to be a compromise. Last report said Salt Creek meets the DO standard and he thought DO problem was from Addison Creek. Certainly wouldn't want this to wind up in litigation, but don't rule it out.

What body has ultimate authority? Who would do project

*This is convoluted in Illinois. Property lines go out to the middle of Salt Creek in Elmhurst and would have to get property rights. IEPA is responsible for water quality. IDNR is responsible for fish and animals. In this case there is one property owner – the Forest Preserve District, project can not happen without their consent. What will happen is that the Workgroup will do the data collection, hire a design consultant through grants, hand over the project to DuPage County Stormwater because they have the resources and knowledge to implement the project.*

What is the authority of the Village of Oak Brook?

*Answer by Village Trustee - the Village has no authority. If the residents say that don't want any change the Village can make a formal statement to the Forest Preserve District, the Workgroup, the IEPA.*

Wouldn't the work require a construction permit from the Village because it's within the Village limits?

*Not aware of how permitting would function*

What agency is requiring the Forest Preserve District to do this?

*IEPA is requiring water quality improvements. The best way to advance to those improvements is to reduce the size of the impoundment.*

Last meeting, it was indicated another dam upstream of Graue Mill would be removed or breached. Wouldn't it be prudent to do that first?

*We are trying to get the biggest bang for our buck. We are discussing removing the dam at Oak Meadows with Forest Preserve District. Old Oak Brook dam is not that big of a DO problem because it has a small impoundment.*

What about flooding, salt, parking lot runoff?

*NPDES Phase II addresses stormwater. The program is in its 6th year. It changes how stormwater is treated. Silt fence, grassy swales, are Best Management Practices (BMPs), which are required to be implemented in communities to treat stormwater runoff. Stormwater is the second biggest problem in Salt Creek. The Workgroup has been very active in chloride education and is also looking at stormwater.*

Russ Strand from Robin Hood Ranch: Report says Salt Creek is an effluent dominated stream, what does that mean?

*Salt Creek is dominated, approximately 85%, by wastewater effluent at low flow conditions, (when it's not raining). This starts at the Eagen plant in Schaumburg and goes all the way to Elmhurst.*

What is a combined sewer overflow (CSO)?

*Every community has a sewer collection system. A CSO is storm and sanitary sewers in one system. Elmhurst and Oak Brook have separate sanitary sewers which go to the treatment plant. The storm sewer goes directly to the river. In a CSO, all flow goes to the plant and is fully treated for up to the 10 year storm event. For the 10 year storm event and above, the flow bypasses part of the treatment plant, after it is treated through gravity and separation. A 10 year event or greater is very diluted.*

What is a sanitary sewer overflow (SSO)? Flagg Creek POTW example

*An SSO should never happen, it's a violation of the Clean Water Act. It happens when the sanitary collection system is overwhelmed. It consists of very diluted material, but it is illegal.*

He has picked up material in Fullersburg Woods. Syringes, etc.

*This information was shared with the Forest Preserve District and Flagg Creek Sanitary District after the last meeting. It could be many things, such as a sewer blockage or collapse.*

He'd like to see these things fixed before we talk about taking out the dam.

*Agreed*

Do you have any flexibility or judgment in this issue? The fact that you want to turn this into a swamp is offensive to me. Why are we returning this is the mosquitoes? You used models, the global warming model from 20 years ago are wrong. Models can say whatever you want them to say.



*The Clean Water Act does not have exemptions. Our flexibility is how we can implement these things. We've thought about merging what was done at the Kent dam with breaching, that was a flexible approach.*

*On mosquitoes the situation is quite the reverse, mosquitoes love low DO and still water – the impoundment is more desirable than a moving river. Also in free flowing conditions more fish are available to consume mosquito larvae. Yes models can say what you want it to say. They have also proven powerful tools for predicting events. On top of the model, we have three years of continuous DO monitoring. All other parameters were directly sampled – habitat, fish, macro invertebrates. Once again the goal is water quality not a certain action.*

How much does the impoundment have to be reduced by to meet minimum DO standard?

*Look at the display boards in the back of the room. This is the kind of flexibility we have – if we reduce the hydraulic head of the dam by 2.5 feet, the river will draw down by 3 feet, not sure what the area of the impoundment would be, but this would meet the DO standard.*

Can residents participate in the committee?

*Tom Richardson said that he is a resident of Oak Brook and a member of the committee, as well as Joe Rush from the Fullersburg Woods Association, Karen Bushy from Graue Mill, and another Oak Brook resident.*

*So far the Workgroup has confirmed that there is a water quality problem. We're not rushing to provide any solutions, there is much more time for community input.*

Has there been any consideration of the change in property values? Where the bridge goes over the creek, the creek is 90 feet wide and will be reduced to 20-40 feet. The creek is hard to see. Vegetation and trees will further hide it.

*The Forest Preserve District will be a major partner and they will have to look at the management plan. Will provide information on property values*

Everyone keeps saying this is not a dam issue, it is a dam issue. The dam has been there since the 1850's. The perspective given is always from the south side of the creek looking away from the mill, the mill would sit without any water around it and would look very unnatural. This is human habitat and we need to look at the human side of the story. Partial removal will destroy what the dam is. The mill was a site on the underground railroad.

The dam was built to control water, to regulate flow. If you open up the dam, how will you control erosion down stream?

*The dam was not built for flood control or erosion control. Flood levels and erosion cannot change under the current permitting system. The dam was built as a hydraulic battery.*

It was said before that the dewatering gates were not enough, that 60 feet of the dam would have to be removed and that the dewatering gates are only 25-30 feet. We don't need an all or nothing approach. We should strategically place a bunch of rocks upstream and open the gates from Monday through Thursday. Close the gates for the weekend.

*This maybe done as a demonstration and to gather further data. In the long term, it is not feasible because the capacity is not there and the Forest Preserve District does not want to clean the dewatering gates frequently.*

The Forest Preserve District works for the taxpayers.  
What about the ducks, geese and the one heron?

*The habitat will bring more birds. We currently have puddle ducks. There will be more herons because they are fishermen.*

If the stream is effluent dominated, what are our native fish species?

*16<sup>th</sup> and Spring Road is the location of the first native flow. Upstream of that it was stormwater. The Des Plaines has always had a constant flow. The fish migrated upstream.*

Did you do BOD measurements with normal flow.

*No.*

26 villages are contributing (to the Workgroup), what is the total amount of the bill (for the Salt Creek DO study)?

*\$300,000 for all the studies on Salt Creek. .*

Proposal to dredge and let the creek go down, open the flood gates and when the sludge dries out use front loaders to put it on Forest Preserve District land. Dredge down to clay. It will be cheaper. A million dollars will be used, there are lots of millionaires in this room, about half. We're not talking about that much money.

My understanding is that the mill would be shut down part of the time, and the wheel would only turn part of the time. When I come under the bridge in my costume it's like Brigadoon. Kids do change in their heads. It's a wonderful place for schools; they come to Robert Crowne and Graue Mill. Those who work there love it.

*The wheel will turn under all scenarios.*

### **Comment Box:**

This is a public issue. Water quality affects everyone. Oak Brook residents' views of the creek as it is now are not a concern. It's not just fish – it's also habitat. All over the U.S. dam removal is occurring – in every case all aspects of the water are improving. Oak Brook Village has no legal authority over the removal or change in the dam.

I have been a life-long fisherman, and an avid Salt Creek fisherman for the past half-decade and what bothers me is how many local residents claim this dam removal issue is about "Heritage vs. Fish". I wholeheartedly disagree. I take pride in being able to catch big Pike and Walleyes from my own backyard rather than travel to some foreign or out of

state destination...It is about removing Salt Creek's nickname as "sewer ditch" and cleaning up our own backyards.

Remember, Salt Creek was once incredibly impaired and unusable a few decades ago with no fish ...clean-up and restoration is still not over yet. The more we sit and wait on this dam at Graue Mill to continue crumbling and killing further aquatic life at its upstream and downstream sections, the more power it will take to make significant improvements to the creek's overall water quality and environmental sustainability.